

Effective 1st March 2021



# CATALOGUE 2021/22

Blind rivets, blind rivet nuts and riveting tools

A member of **SFS**

**GESIPA**<sup>®</sup>  



<b>Customer ID</b>		
<input type="text"/>	<input type="text"/>	<input type="text"/>
<b>Your in-house representative</b>	Telephone number	Or extension
<input type="text"/>	<input type="text"/>	<input type="text"/>
<b>Your field sales representative</b>	Telephone number	
<input type="text"/>	<input type="text"/>	

Follow us on



[www.gesipa.com](http://www.gesipa.com)  
[youtube.com/gesipa-videos](https://youtube.com/gesipa-videos)

# Overview

Please find the detailed table of contents on page 6.



**Blind rivets**



**Cordless blind rivet setting tools**

Manual blind rivet setting tools



**Pneumatic blind rivet setting tools**

Hydro-pneumatic blind rivet setting tools



**Speed rivet technology**

Fasteners and setting tools



**Lockbolt setting tools**



**Blind rivet nuts**



**Cordless blind rivet nut setting tools**

Manual blind rivet nut setting tools

Battery-powered blind rivet nut setting tools



**Pneumatic blind rivet nut setting tools**

Hydro-pneumatic blind rivet nut setting tools



**Point of Sale / Do it yourself**



**Spare part catalogue**

# GESIPA®'S NEW PRODUCTS



## OUR NEWS AT A GLANCE!

### The new Bird Pro Series with the Cordless Alliance System

More than 200 electrical devices – but just one battery!

**S. 72 / S. 214**



### iBird® Pro C

The newest member of the Bird Pro Series with setting process monitoring – it safeguards processes reliably and without cords!

**S. 84**

Connected with the new GESIPA® Interface 4.0!



### Nosepiece allocation card

The new card facilitates the selection of the correct nosepiece for the respective tools.

**S. 135**

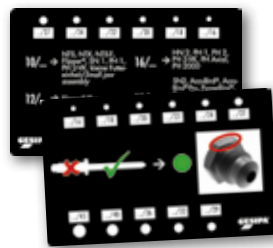

## CATALOGUE GUIDE

### BLIND RIVET/BLIND RIVET NUT DIMENSIONS acronyms

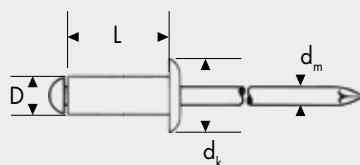

D = Rivet body Ø  
L = Rivet body length  
d<sub>k</sub> = Setting head Ø  
d<sub>m</sub> = Mandrel Ø

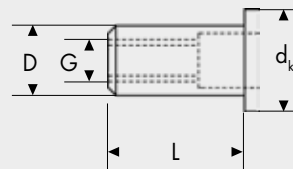

D = Rivet nut body Ø  
L = Rivet nut body length  
d<sub>k</sub> = Setting head Ø  
G = Thread dimension

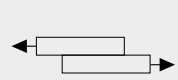

Shear strength

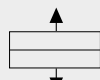

Tensile strength

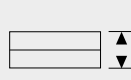

Grip range



Hole Ø = d<sub>h</sub>

## SYMBOLS FOR BATTERY AND CHARGER

NEW

### Bird tools



Battery  
14.4 V / 2.0 Ah



2 batteries in  
scope of delivery



Charger 14.4 V Li-Ion

### Bird Pro tools



CAS battery  
18 V Li-Ion / 2.0 Ah



2 batteries in  
scope of delivery



Charger 18 V Li-Ion



Tool is delivered  
in the L-BOXX



Tool is delivered  
in a plastic case



Tool is delivered  
in a carton

### PART NUMBERS

Our part numbers are  
marked by **No.**

**No.145 0810**

NEW

### COLOR LEGEND of blind rivet materials

	Alu
	Steel
	Stainless steel A2
	Stainless steel A4
	Copper
	Plastic
	Monel® (Nickel-copper alloy)

### PAGE REFERENCE

This symbol refers to  
the page number.



### CE MARKING

The EU Construction Products Regulation (CPR) No.  
305/2011 came into effect in June 2013. The approved  
products in our catalogue are marked with the CE symbol.  
The relevant approval documents can be found in the  
download area at **www.gesipa.com**.

In accordance with ETA approval **ETA-13/0255**



### AVAILABILITY

This product is made to order.  
Contact our Customer Service for  
detailed information on availability.



### QR-CODES / VIDEOS

Scan the QR codes to receive  
more information or watch  
videos about products



Video



Product information

Don't you have a  
QR Code scanner?  
Then simply use the  
Google Play Install  
App Store for free

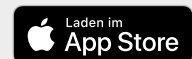

### More dimensions and Types available on request.

We reserve the right to make changes  
for the entire catalogue. We do not  
accept liability for errors or misprints.

The applicable terms and conditions of  
guarantee shall apply and can be viewed  
under following link: [https://en.gesipa.de/  
service/manufacturers-warranty/](https://en.gesipa.de/service/manufacturers-warranty/)



# CONTENTS



20

## PROGRAM BLIND RIVET TECHNOLOGY

### 1 Blind rivets

Blind rivets .....	19
PolyGrip®, coloured blind rivets, SolarGrip®, CAP®, special blind rivets, G-Bulb, PolyBulb, MEGA GRIP®, BULB-TITE®, TRI-FOLD®, Solid Riveting .....	33

### 2 Cordless blind rivet setting tools

<b>Blind rivet hand tool</b> .....	62
NTS, NTX, NTX-F, Flipper®, Flipper® Plus, HN 2, HN 2-BT, SN2	
<b>Battery-powered blind rivet setting tools</b> .....	72
<b>Bird Pro series</b> .....	72
AccuBird® Pro, PowerBird® Pro Gold Edition, iBird® Pro, iBird® Pro C	
Bird® Pro series with spring-loaded trigger system	
AccuBird® .....	90

### 3 Pneumatic blind rivet setting tools

<b>TAURUS® series</b> .....	98
TAURUS® 1-6 .....	102
TAURUS® versions: TAURUS® 2/K, TAURUS® 2/AS, TAURUS® 2/24, TAURUS® 1-4 with counter device, TAURUS® 1-4 with counter device eco, TAURUS® 4 CF, TAUREX 1-6, TAURUS® 1-4 Axial eco, TAURUS® 1-4 Axial, TAUREX 1-4 Axial compact, TAUREX Axial 1-4, TAURUS® 1-4 C AV, TAURUS® WinTech .....	110
<b>Hydro-pneumatic blind rivet setting tools</b> .....	122
PH2, PH2 VK, PH Axial	
<b>Automatic riveting machines</b> .....	136
GAV 8000 eco, GAV 8000 electronic, GAV HF	
<b>GESIPA®-assembly cell</b> .....	148

### 4 Speed rivet technology .....

<b>Fasteners:</b> G-Speed®, Speed-Bulb® .....	153
<b>Tools:</b> TAURUS® 1 Speed Rivet, TAURUS® 2 Speed Rivet, TAURUS® 1 Speed Rivet Axial eco, TAURUS® 2 Speed Rivet Axial eco .....	161

### 5 Lockbolt setting tools .....

TAURUS® 3 SRB, TAURUS® 4 SRB, TAURUS® 4 SRB with angle head 90° compact	
---	--



**170**

## **PROGRAM BLIND RIVET NUT TECHNOLOGY**

### **6 Blind rivet nuts**

Blind rivet nuts .....	176
Blind rivet nuts closed end (CAP®) .....	186
Blindnietmuttern Light Weight .....	188
Blindnietmuttern High Strength.....	190
Blindnietmuttern Torque Resistant .....	191
Blindnietmuttern G-Sealed® .....	192
PolyGrip® blind rivet nuts .....	193
SoftGrip® blind rivet nuts .....	196
Blind rivet nut studs .....	198
PolyGrip® blind rivet nut studs splined .....	200
Blind rivet nuts with hose connection .....	201

### **7 Cordless blind rivet setting tools**

<b>Blind rivet nut hand tools</b> .....	204
GBM 10, GBM 40-R, GBM 50, FireFly, Flipper® Plus	
<b>Battery-powered blind rivet nut setting tools</b> .....	214
FireBird® Pro, FireBird® Pro Gold Edition, FireBird® Pro S Gold Edition, FireBird®, FireBird® with conversion kit for blind rivet nut studs	

### **8 Pneumatic blind rivet nut setting tools**

FireFox® 1, FireFox® 1 F, FireFox® 2 , FireFox® 2 F, FireFox® 2 F L, FireFox® 1 F with conversion kit for blind rivet nut studs, FireFox® 2 with conversion kit for blind rivet nut studs, FireFox® 1 F Axial eco, FireFox® 2 F Axial eco, FireFox® 2 F Axial eco with contact pressure monitoring and counting device, FireFox® 2 C, FireRex®, FireRex® 2 C.....	224
--	-----



**246**

## **POINT OF SALE / DO IT YOURSELF**

<b>9 POS:</b> Retailer area, sales wall, in-house trade fairs .....	246
<b>DIY:</b> NTS, Nietboy, Blind rivet assortment, GBM 5, Blind rivet nut assortment, Service-Pack, Mini-Packs.....	248



**252**

## **SPARE PARTS CATALOGUE**

# GESIPA® – AT A GLANCE

A member of **SFS**

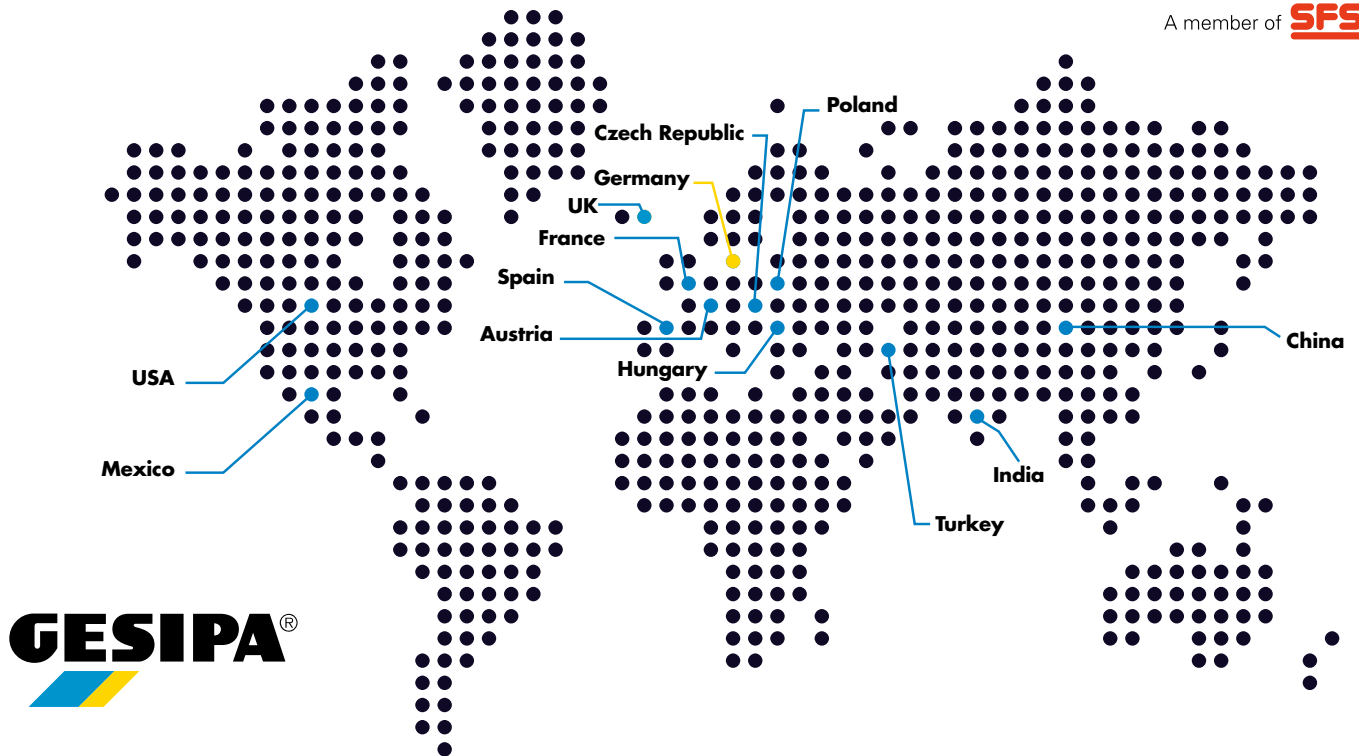

# 1955

year of foundation. High standards, the reliability of GESIPA® fasteners, innovative, high-quality setting tools and process-oriented consulting services have made GESIPA® a valuable and valued partner for trade and industry. Family-owned until the end of 2008, GESIPA® is now a member of the international SFS Group.



**PRODUCTION  
SITES AROUND  
THE WORLD**

**ALWAYS AT YOUR SIDE WITH BRANCHES  
AND AGENCIES ON ALL CONTINENTS**



# GESIPA BLINDNIETTECHNIK GMBH



## GESIPA BUSINESS UNITS

Application-optimised and cost-effective joining solutions

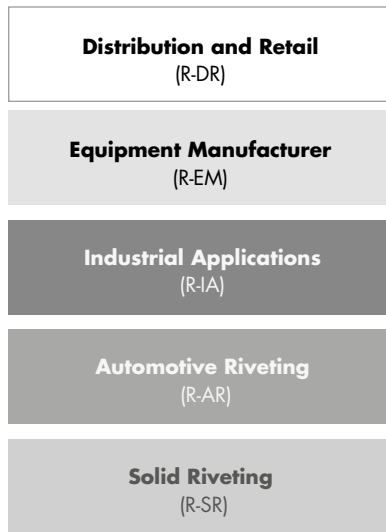

GESIPA® riveting technology focuses on **five** customer segments. The top priority is the direct relationship with the customer and his specific requirements with the aim of designing application-optimised and cost-effective joining solutions.

All German GESIPA® production locations operate a quality management system certified to IATF 16949



**CUSTOMER PROXIMITY** and **FLEXIBILITY** are certainly given top priority at GESIPA®. The creativity and openness to innovation of all our employees contribute to lasting customer satisfaction and partnership-based cooperation.

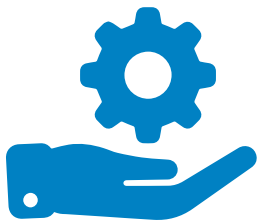

**GESIPA®-SERVICE**  
Take advantage of GESIPA® Services – a multitude of services from a single source for a simple and straightforward process.



**SUSTAINABILITY IS IMPORTANT TO US!**  
Ergonomics and economical energy consumption are priorities for us in our setting tools.

**MADE IN GERMANY**  
Tools and fasteners that are Made in Germany. At our three German locations, we manufacture top-quality blind rivets and setting tools for international demand.



**IN THE BEST HANDS AT GESIPA®!**  
Highly skilled staff, top-level production machines and manufacturing quality controls guarantee fulfilment of our customers' most stringent demands.

# GESIPA®-SERVICE\*

**GESIPA® – Comprehensive range of services from under one roof**

## INITIAL SAMPLE INSPECTION (PPAP, VDA 2)

Initial sample inspection verifies that, prior to the start of series production, the customer requirements agreed upon in the specification as well as other requirements (e.g. legislation, standards) in terms of the product and process are met. The same also applies to the annual re-qualification

## WORLDWIDE SERVICE

The people at GESIPA® are committed and passionate about providing high-quality, innovative products every day, worldwide. GESIPA® is at your side on every continent through our own sites or our trade partners.

## NEW GESIPA®-REPAIR SERVICE

Further Information to our optimized Repairservice here:



## REPAIR SERVICE

GESIPA® processing tools are manufactured to the highest quality standards. However, should repairs ever become necessary our technicians will provide fast and reliable assistance.

## FIRMWARE UPDATE

Firmware updates are available on request to keep your processing systems up-to-date, making sure they operate reliably safely and efficiently at all times.

## FACTORY CALIBRATION

Process-monitored riveting tools are calibrated based on applicable test standards as part of the GESIPA calibration service. The calibration standard used is verified by routine test equipment monitoring. We can also carry out the calibration procedure directly on your premises.



\*These services vary specific to country and are based on the service programmes available at the Walldorf/Germany site.

### **MAINTENANCE & SERVICING AGREEMENTS**

Regular servicing and maintenance are required to ensure processes and production runs smoothly. Servicing and maintenance are the foundation for guaranteeing high availability of your production facilities where downtimes are minimised, thus keeping costs down. These procedures also increase operational safety thereby protecting your personnel.

### **TECHNICAL TALKS**

Whether in our Demonstration Center, on your premises or at conferences: when it comes to selecting the venue and time we are really flexible. Talks aimed at specific target groups

### **TRAINING**

We hold training courses for our customers' staff at our training centres or, if required, on site. The innovative training programme includes training courses on equipment, GAV systems as well as foundation and advanced courses.

### **ONLINE-SERVICE**

More Infos here:



 ARTIKEL KAUFEN

 BUY THE PRODUCT

### **ONLINE-SERVICE**

GESIPA® uses the Oxomi platform to maintain close ties with our customers. At the POS and across our network, we provide our customers with the latest marketing materials such as brochures, operating instructions, product videos, etc. online and offline via our homepage or mobile app. In addition, most of our products can now also be ordered directly from our authorised trade partners via the **BUY NOW button** on our homepage. Delivery times and prices of the trading partner are displayed with one click.

### **COMMISSIONING**

Following the installation of a machine, comprehensive customer service is provided by our resourceful service team. The service team carries out both the commissioning as well as the maintenance of the machine.

# **BLIND RIVET TECHNOLOGY**

- » trust
- » move
- » know
- » understand
- » create



# GESIPA®-BLIND RIVETS

GESIPA® BLIND RIVETS PROVIDE A LASTING AND SAFE JOINT FOR DIVERSE AND SENSITIVE MATERIALS.

## GESIPA® BLIND RIVETS – EFFICIENT TECHNOLOGY

Life without blind rivet technology from GESIPA® can no longer be imagined in modern industry production where fastening technology is required due to its efficiency and versatility. It combines the advantages of overcoming restricted component accessibility, permanently safe connection of different, and specialised materials, and even documentation of the setting process if required.

Technically speaking, the blind rivet consists of two parts: the rivet body and the mandrel. During screw-connecting, clinching and punch riveting etc. the application must always be accessible on both sides but the special thing about blind riveting is that the application only needs to be accessed from one side.

## GESIPA® BLIND RIVETS – CONNECTIONS THAT LAST

During the setting process, the mandrel is pulled by the jaws of the setting tool and forms the rivet body to the predefined fixed position in the application. The mandrel then breaks off at the intended point (the target breakage point) and can be recycled. The filling cut (this is the remaining rest of mandrel in the rivet body) can provide an additional securing function depending on the application.

## GESIPA® BLIND RIVETS – FOR EVERY APPLICATION

Blind rivets are available in a variety of designs, materials, forms, lengths and even colours. Depending on the task which the blind rivet should fulfil, GESIPA® can choose between a standard model available from stock or a blind rivet specially designed for the application.

## GESIPA® BLIND RIVETS – A RULE OF THUMB

**Material thickness + rivet diameter = rivet body length**

### Example

Material: metal sheet 3 mm + metal sheet 3 mm + hole 4 mm  
= 10 mm rivet body length > blind rivet **4 x 10**

Representation in the table

D	D x L mm	 mm	No.
4	4 x 10	5.0 - 6.5	143 3487



# TECHNICAL DATA on GESIPA® blind rivets

## BLIND RIVET BEFORE SETTING PROCESS

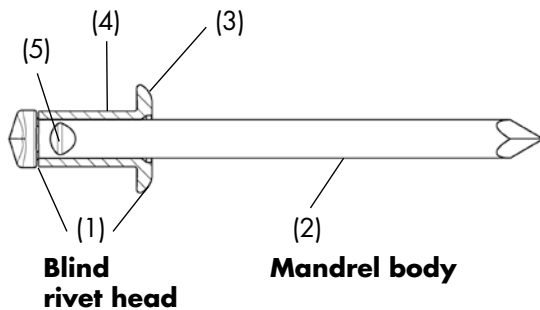

## BLIND RIVET AFTER SETTING PROCESS

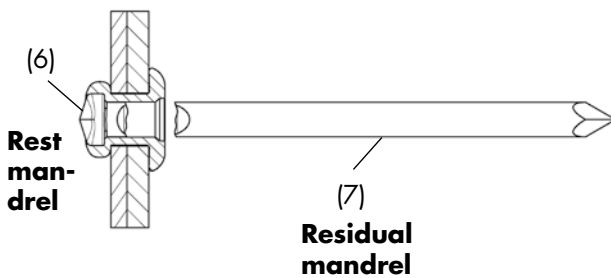

## GESIPA®-BLIND RIVETS – DEFINITIONS

- The blind rivet consists of two parts: the **blind rivet head** (1) and the **mandrel body** (2).
- The rivet body consists of the **setting head** (3) and the **shaft** (4).
- The setting head is found on the processing side and is variable in diameter and shape. There are **dome**, **countersunk** and **large flange** versions. The rivet body is available in different lengths depending on the material thickness to be riveted.
- The rivet mandrel is used to deform the rivet body. It contains the **predetermined breaking point** (5). This is where the rivet mandrel breaks after the rivet has deformed.
- The **rest mandrel** (6) is the remaining part of the rivet mandrel in the rivet body. The **residual mandrel** (7) is the part of the rivet mandrel that is disposed of from the set rivet via the blind rivet setting tool.

## BLIND RIVET- DIMENSIONS /SYMBOLS

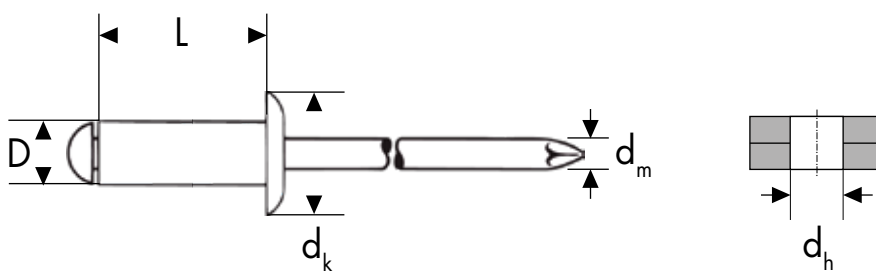

- D = Rivet body  $\varnothing$
- L = Rivet body length
- $d_k$  = Setting head  $\varnothing$
- $d_m$  = Mandrel  $\varnothing$
- $d_h$  = Hole  $\varnothing$

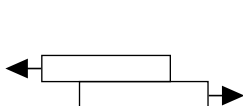

Shear strength

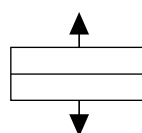

Tensile strength

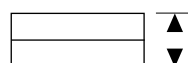

Grip range



hole  $\varnothing = d_h$



For the hole  $\varnothing$  is generally a tolerance of +0.1 / 0 to note!

# IN THE BEST HANDS AT GESIPA®

Special challenges in industry demand special solutions with regard to efficiency, function and innovation. GESIPA® has decades of experience in consultancy and development of blind rivets for specific applications. Requirements such as surface treatments, appropriate shear strength and/or tensile strength and setting process reliability are defined by Technical Sales according to the project, and guarantee millions of consistent quality fastenings.

## QUALITY

From the traceability and documentation of the raw materials to the checking of dimensions and tolerances during production, GESIPA® attaches the greatest value to quality. But GESIPA® also goes one decisive step further. For blind rivets for specific applications, thorough functional tests are carried out and documented step-by-step.

## FUNCTIONAL TEST /SETTING CURVE

For every production batch of blind rivets for specific applications, the setting curve is measured on a sophisticated test bench. The measured results of shaft deformation, insertion characteristics, mandrel shear load and tensile force are compared with the target values in order to ensure that the blind rivet forms as intended in the application and produces a secure fastening.

## FUNCTION TESTS/MANDREL PUSH-OUT FORCE (1)

The remaining part of the mandrel enclosed in the set rivet is pushed out. The measured force can be used to determine whether the remaining part of the mandrel is properly locked and will not cause any rattling noises or even fall out. The batch is only released if both these values are within tolerance.

## MONITORED PROCESS – RELIABLE CONNECTION (2)

Safety relevant processes in the industrial use of blind rivets make 100% reliability of riveting operations essential. The process-controlled GESIPA® tools enable economic application solutions, from the basic system to systems with barcode scanners and process computers.

## ONE FASTENER FOR SEVERAL APPLICATIONS

The versatility of GESIPA® fasteners often means that several application cases which previously required different fasteners can be served by a single specially designed blind rivet. This saves costs and simplifies handling.

## COST ADVANTAGES AT A GLANCE

- Reduction of downstream quality costs due to GESIPA® setting process monitoring
- Reduction of wearing parts costs due to identical parts strategy and modular design of the tools
- Reduction of logistics costs due to multi-functionality of the fasteners and corresponding reduction of parts diversity.

(1)

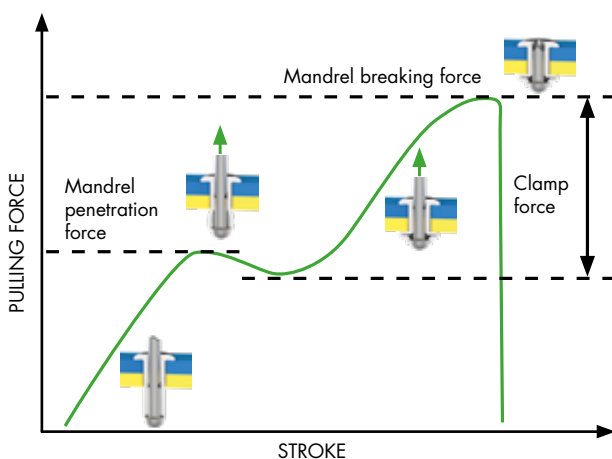

(2)

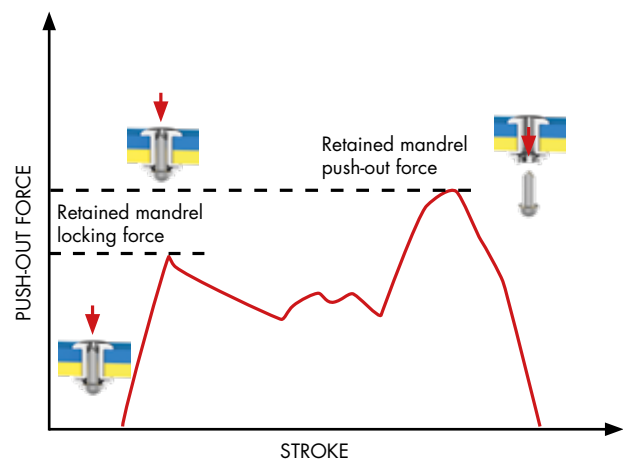

# CORROSION PROTECTION AND WATERTIGHTNESS

Our fasteners provide corrosion protection and watertightness to various extents depending on the material chosen. The features of the individual fasteners are shown in the following tables:

Category	Water tightness	Corrosion resistance
<b>STANDARD BLIND RIVETS</b>		
Alu/Steel		••
Alu/Stainless steel		•••
Alu/Alu		•••
Steel/Steel		•
Copper/Steel		••
Copper/Bronze		•••
Stainless steel/Stainless steel		••••
Stinox		••
<b>POLYGRIP® BLIND RIVETS</b>		
Alu/Steel	**	••
Alu/Stainless steel	**	•••
Steel/Steel		•
Stainless steel/Stainless steel		••••
SolarGrip® with (SolarSeal-coating)	**	••••
<b>CAP® BLIND RIVETS</b>		
Alu/Steel	*	••
Alu/Stainless steel	*	•••
Stainless steel/Stainless steel	*	••••
Copper/Steel	*	••
Copper/Stainless steel	*	•••
<b>SPECIAL BLIND RIVETS</b>		
Painted blind rivets alu/stainless steel		•••
Grooved blind rivets alu/steel		••
Blind rivets thread Steel/Steel		•
Plastic blind rivets (Polyamide)		••••
Peel blind rivets alu/steel		••
Profile clinching rivets alu/steel		••

Category	Water tightness	Corrosion resistance
<b>HIGH STRENGTH STRUCTURE BLIND RIVETS</b>		
G-Bulb steel/steel		•
G-Bulb Stainless steel/stainless steel		•••
MEGA GRIP® alu/ alu	**	••
MEGA GRIP® steel/steel	**	•
<b>Folding Type blind rivets</b>		
BULB-TITE® blind rivets alu/alu	*	••
TRI-FOLD® blind rivets alu/alu		••
<b>STANDARD AND POLYGRIP® BLIND RIVET NUTS</b>		
Alu		•••
Steel		•
Stainless steel		••••
Monel®		••••
<b>BLIND RIVET NUT STUDS</b>		
Steel		•

- \* Fastener is watertight
- \* Joint is watertight when a washer is used
- \*\* Splash-proof

- low
- middle
- high
- very high

Further sizes, special surface treatments or materials are available upon request.



# THE APPLICATION-SPECIFIC GESIPA® FASTENING

The basic features of the standard blind rivet are defined by various DIN EN ISO standards. These features primarily involve the geometric dimensions and mechanical properties. Other fastener properties, such as the choice of material and surface coating, are defined very generally

by the standards and are left up to the manufacturer. These specifications about the blind rivet features seriously limit the tolerances of the connection parameters and the feasible requirements. Blind rivets that comply with DIN EN ISO standards are always designed for fixed parts.

CUSTOMER REQUIREMENT	GESIPA® SOLUTION
Adaption to rubber, wood, plastic and other materials	Definition of max. / min. tightening value or clamping force
Watertightness	Material + stamping + coating
Accessibility problem	Extended nosepiece in combination with a rivet mandrel extension
Corrosion resistance	Through organic and inorganic surfaces e.g. Zn, ZnNi, Delta Seal, stainless steel A2 and A4 or Monel® Organic Topcoat
No noise	Monitored rest mandrel locking
Tolerance compensation	Borehole diameter larger than DIN
High device and system availability	Device and fastener matched to each other, GESIPA®-general system

## GESIPA®-FEM SIMULATION

### EFFICIENT AND CUSTOMER-ORIENTED DEVELOPMENT USING FEM SIMULATION

The Finite Element Method (FEM) works by breaking down a component into a finite number of defined geometric elements. Boundary conditions, such as the application of force and displacement, can be defined for these elements, and the structure's reaction can be calculated by applying physical laws.

The result is the virtual simulation of deformation processes in the production process or the process of setting a joining element.

#### BENEFITS

- Simulation integrated into the concept phase
- Efficient, fast and customer-oriented development
- Shorter development times
- Reduction of development costs
- Targeted tool design and optimisation
- Avoidance of errors during the production process
- Savings in quality costs

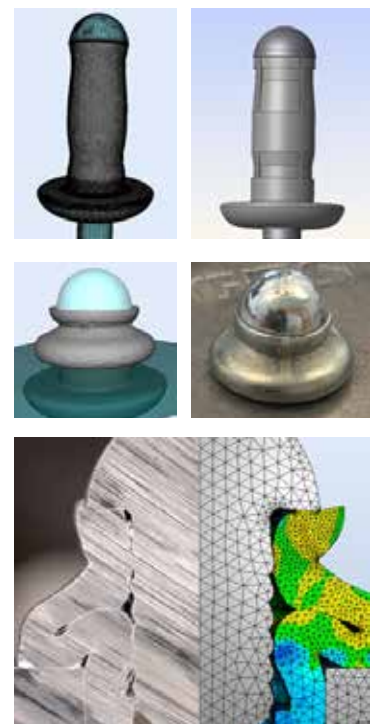



## **BLIND RIVET RANGE**

- » **multifunctional**
- » **resistant**
- » **application-specific**

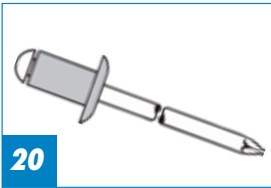
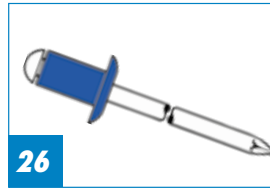
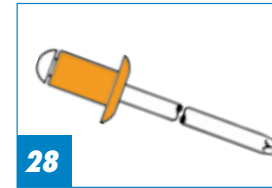

# OVERVIEW of the GESIPA® blind rivet product range

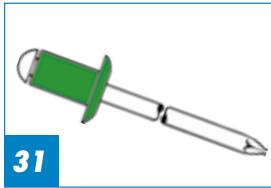
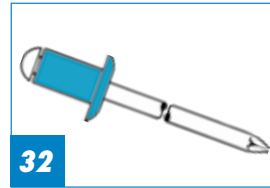
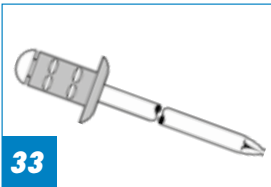
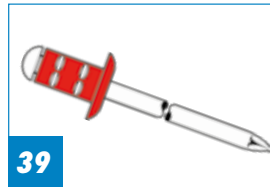
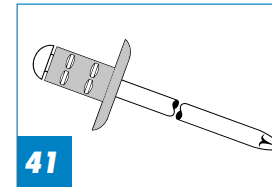
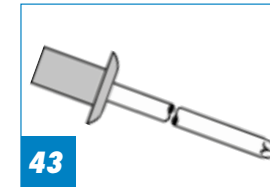
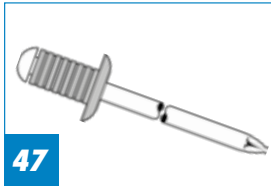
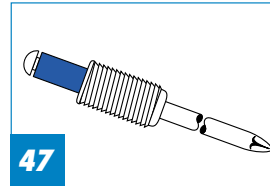
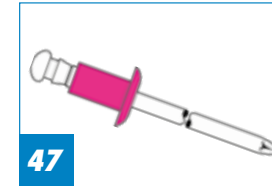
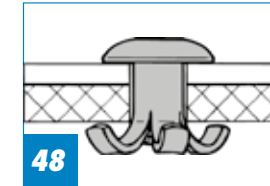
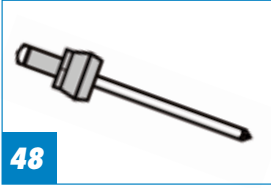
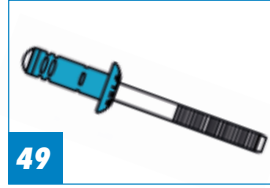
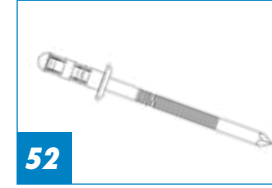
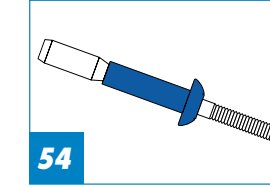
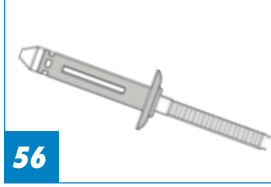
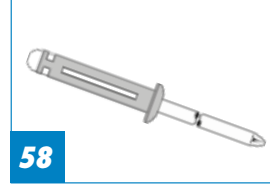
 <b>20</b>				
	Alu	Steel	Cooper	A2 Stainless steel
				
	A4 Stainless steel	Stinox		
				
	PolyGrip®	Coloured PolyGrip®	SolarGrip®	CAP®
				
	Grooved	Threaded	Plastic	Peel
				
	Profile clinching	G-Bulb	PolyBulb®	MEGA GRIP®
				
	BULB-TITE®	TRI-FOLD®		







# BLIND RIVETS **ALU/STEEL**

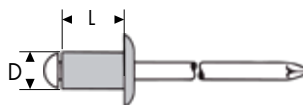

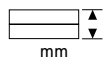



## Standard Dome head

 Aluminium alloy



 Steel, zinc-plated



D	D x L mm	 mm	No.		
<b>2.4</b>  2.5 mm	<b>2.4 x 4</b>	0.5 - 2.0	<b>145 4019</b>	A 1,000	
	<b>2.4 x 6</b>	1.5 - 3.5	<b>143 3464</b>	A 1,000	
	<b>2.4 x 8</b>	4.0 - 6.0	<b>145 4020</b>	A 1,000	
<b>3</b>  3.1 mm	<b>3 x 4</b>	0.5 - 1.5	<b>143 3466</b>	A 500	
	<b>3 x 5</b>	1.5 - 2.5	<b>143 3467</b>	A 500	
	<b>3 x 6</b>	2.5 - 3.5	<b>143 3468</b>	A 500	
	<b>3 x 7</b>	3.5 - 4.5	<b>143 3469</b>	A 500	
	<b>3 x 8</b>	4.5 - 5.0	<b>143 3470</b>	A 500	
	<b>3 x 10</b>	5.0 - 7.0	<b>143 3471</b>	A 500	
	<b>3 x 12</b>	7.0 - 9.0	<b>143 3472</b>	A 500	
	<b>3 x 14</b>	9.0 - 11.0	<b>145 4022</b>	A 500	
	<b>3 x 16</b>	11.0 - 13.0	<b>145 4023</b>	A 500	
	<b>3 x 18</b>	13.0 - 15.0	<b>145 4024</b>	A 250	
	<b>3 x 20</b>	15.0 - 17.0	<b>145 4025</b>	A 250	
	<b>3 x 25</b>	17.0 - 22.0	<b>143 3473</b>	A 250	
<b>3 x 30</b>	22.0 - 26.0	<b>145 4026</b>	A 250		
<b>3.2</b>  3.3 mm	<b>3.2 x 4</b>	0.5 - 1.5	<b>143 3475</b>	A 500	
	<b>3.2 x 6</b>	1,5 - 3,5	<b>143 3476</b>	A 500	
	<b>3.2 x 8</b>	3.5 - 5.0	<b>143 3477</b>	A 500	
	<b>3.2 x 10</b>	5.0 - 7.0	<b>143 3478</b>	A 500	
	<b>3.2 x 12</b>	7.0 - 9.0	<b>143 3479</b>	A 500	
	<b>3.2 x 14</b>	9.0 - 11.0	<b>143 3465</b>	A 500	
	<b>3.2 x 16</b>	11.0 - 13.0	<b>143 3480</b>	B 500	
	<b>3.2 x 18</b>	13.0 - 15.0	<b>143 3483</b>	B 500	
	<b>3.2 x 20</b>	15.0 - 17.0	<b>143 3481</b>	B 500	
	<b>3.2 x 25</b>	17.0 - 22.0	<b>143 3482</b>	B 500	
	<b>4</b>  4.1 mm	<b>4 x 5</b>	0.5 - 1.5	<b>143 3484</b>	A 500
		<b>4 x 6</b>	1.5 - 3.0	<b>143 3485</b>	A 500
<b>4 x 7</b>		3.0 - 4.0	<b>145 4028</b>	A 500	
<b>4 x 8</b>		4.0 - 5.0	<b>143 3486</b>	A 500	
<b>4 x 10</b>		5.0 - 6.5	<b>143 3487</b>	A 500	
<b>4 x 12</b>		6.5 - 8.5	<b>143 3488</b>	B 500	
<b>4 x 14</b>		8.5 - 10.5	<b>145 4029</b>	B 500	
<b>4 x 16</b>		10.5 - 12.5	<b>145 4030</b>	B 500	
<b>4 x 18</b>		12.5 - 14.5	<b>145 4031</b>	B 500	
<b>4 x 20</b>		14.5 - 16.5	<b>145 4032</b>	B 500	
<b>4 x 25</b>		16.5 - 21.5	<b>145 4033</b>	B 500	
<b>4 x 30</b>		21.5 - 26.0	<b>145 4034</b>	B 250	
<b>4 x 35</b>		26.0 - 30.0	<b>145 4035</b>	B 250	
<b>4 x 40</b>		30.0 - 35.0	<b>145 4036</b>	B 250	

D	D x L mm	 mm	No.	
<b>4.8</b>  4.9 mm	<b>4.8 x 6</b>	2.0 - 2.5	<b>143 3493</b>	B 500
	<b>4.8 x 8</b>	2.5 - 4.5	<b>143 3494</b>	B 500
	<b>4.8 x 10</b>	4.5 - 6.0	<b>143 3495</b>	B 500
	<b>4.8 x 12</b>	6.0 - 8.0	<b>143 3496</b>	B 500
	<b>4.8 x 14</b>	8.0 - 10.0	<b>145 4043</b>	B 500
	<b>4.8 x 16</b>	10.0 - 12.0	<b>143 3497</b>	B 500
	<b>4.8 x 18</b>	12.0 - 14.0	<b>145 4044</b>	B 500
	<b>4.8 x 20</b>	14.0 - 15.0	<b>145 4045</b>	B 250
	<b>4.8 x 25</b>	15.0 - 20.0	<b>143 3498</b>	B 250
	<b>4.8 x 30</b>	20.0 - 25.0	<b>143 3499</b>	A 100
<b>5</b>   5.1 mm	<b>5 x 6</b>	2.0 - 2.5	<b>143 3500</b>	B 500
	<b>5 x 8</b>	2.5 - 4.5	<b>143 3501</b>	B 500
	<b>5 x 10</b>	4.5 - 6.0	<b>143 3502</b>	B 500
	<b>5 x 12</b>	6.0 - 8.0	<b>143 3503</b>	B 500
	<b>5 x 14</b>	8.0 - 10.0	<b>145 4048</b>	B 500
	<b>5 x 16</b>	10.0 - 12.0	<b>143 3504</b>	B 500
	<b>5 x 18</b>	12.0 - 14.0	<b>145 4049</b>	B 500
	<b>5 x 20</b>	14.0 - 15.0	<b>145 4050</b>	B 250
	<b>5 x 25</b>	15.0 - 20.0	<b>143 3505</b>	B 250
	<b>5 x 30</b>	20.0 - 25.0	<b>145 4051</b>	A 100
	<b>5 x 35</b>	25.0 - 30.0	<b>145 4052</b>	A 100
	<b>5 x 40</b>	30.0 - 35.0	<b>145 4053</b>	A 100
	<b>5 x 45</b>	35.0 - 40.0	<b>145 4054</b>	B 100
	<b>5 x 50</b>	40.0 - 45.0	<b>145 4055</b>	B 100
	<b>5 x 55</b>	45.0 - 48.0	<b>145 4056</b>	B 100
	<b>5 x 60</b>	48.0 - 52.0	<b>145 4057</b>	B 100
	<b>5 x 65</b>	52.0 - 57.0	<b>145 4058</b>	B 100
	<b>5 x 70</b>	57.0 - 62.0	<b>145 4059</b>	B 100
	<b>5 x 80</b>	62.0 - 72.0	<b>143 3506</b>	B 100
	<b>6</b>  6.1 mm	<b>6 x 8</b>	2.0 - 3.0	<b>145 4060</b>
<b>6 x 10</b>		3.0 - 5.0	<b>145 4061</b>	B 250
<b>6 x 12</b>		5.0 - 7.0	<b>145 4062</b>	B 250
<b>6 x 16</b>		7.0 - 11.0	<b>143 3507</b>	B 250
<b>6 x 18</b>		11.0 - 13.0	<b>145 4064</b>	B 250
<b>6 x 20</b>		13.0 - 15.0	<b>145 4065</b>	B 250
<b>6 x 25</b>		15.0 - 20.0	<b>145 4066</b>	B 200
<b>6 x 30</b>		20.0 - 24.0	<b>145 4067</b>	B 200
<b>6 x 35</b>		24.0 - 29.0	<b>145 4068</b>	B 100
<b>6 x 40</b>		29.0 - 34.0	<b>145 4069</b>	B 100
<b>6 x 50</b>	34.0 - 44.0	<b>143 3508</b>	B 100	

# BLIND RIVETS **ALU/STEEL**





D	D x L mm	 mm	No.	
<b>6.4</b>  6.5 mm	<b>6.4 x 12</b>	2.0 - 6.0	<b>145 4070</b>	B 250
	<b>6.4 x 16</b>	6.0 - 10.0	<b>145 4072</b>	"
	<b>6.4 x 20</b>	10.0 - 14.0	<b>145 4073</b>	B 200
	<b>6.4 x 25</b>	14.0 - 18.0	<b>145 4074</b>	"
	<b>6.4 x 30</b>	18.0 - 23.0	<b>145 4075</b>	B 100

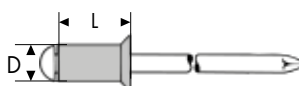

## Countersunk (120°)

 Aluminium alloy

 Steel, zinc-plated



D	D x L mm	 mm	No.	
<b>3</b>  3.1 mm	<b>3 x 6</b>	1.5 - 3.5	<b>145 4078</b>	A 500
	<b>3 x 8</b>	3.5 - 5.0	<b>143 3509</b>	"
	<b>3 x 10</b>	5.0 - 7.0	<b>143 3510</b>	"
	<b>3 x 12</b>	7.0 - 9.0	<b>145 4079</b>	"
	<b>3 x 16</b>	9.0 - 13.0	<b>145 4080</b>	"
<b>4</b>  4.1 mm	<b>4 x 6</b>	1.5 - 3.0	<b>145 4081</b>	A 500
	<b>4 x 8</b>	3.0 - 5.0	<b>143 3512</b>	"
	<b>4 x 10</b>	5.0 - 6.5	<b>145 4082</b>	"
	<b>4 x 12</b>	6.5 - 8.5	<b>143 3513</b>	B 500
	<b>4 x 16</b>	10.5 - 12.5	<b>143 3514</b>	"
<b>4 x 20</b>	14.5 - 16.5	<b>145 4083</b>	"	

D	D x L mm	 mm	No.	
<b>5</b>  5.1 mm	<b>5 x 8</b>	2.0 - 4.5	<b>143 3515</b>	B 500
	<b>5 x 10</b>	4.5 - 6.0	<b>143 3516</b>	"
	<b>5 x 12</b>	6.0 - 8.0	<b>145 4085</b>	"
	<b>5 x 16</b>	8.0 - 12.0	<b>145 4086</b>	"
	<b>5 x 18</b>	12.0 - 14.0	<b>145 4084</b>	"
	<b>5 x 20</b>	14.0 - 15.0	<b>145 4087</b>	B 250
	<b>5 x 25</b>	15.0 - 20.0	<b>143 3517</b>	"
	<b>5 x 30</b>	20.0 - 25.0	<b>145 4088</b>	A 100
	<b>5 x 35</b>	25.0 - 30.0	<b>145 4089</b>	"







The information on shear and tensile strength, rivet pin diameters and the maximum setting head diameters can be found on **page 22**.

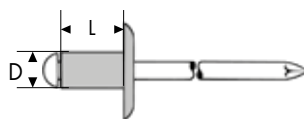
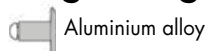

**CE:** ETA certification 13/0255 Corresponding approval documents on [www.gesipa.com](http://www.gesipa.com)  
 All sizes on request – also available in bulk packs

# BLIND RIVETS **ALU/STEEL**

## Large flange





D	D x L mm	mm	No.	
<b>3.2 - K 9.5</b>  3,3 mm	<b>3.2 x 8</b>	3.5 - 5.0	<b>145 4091</b>	"
	<b>3.2 x 10</b>	5.0 - 7.0	<b>145 4092</b>	"
	<b>3.2 x 12</b>	7.0 - 9.0	<b>145 4093</b>	"
	<b>3.2 x 16</b>	9.0 - 13.0	<b>145 4094</b>	B 500
<b>4 - K 12</b>  4.1 mm	<b>4 x 6</b>	1.5 - 3.0	<b>145 4095</b>	B 500
	<b>4 x 8</b>	3.0 - 5.0	<b>143 3518</b>	"
	<b>4 x 10</b>	5.0 - 6.5	<b>145 4096</b>	"
	<b>4 x 12</b>	6.5 - 8.5	<b>145 4097</b>	"
	<b>4 x 16</b>	8.5 - 12.5	<b>145 4098</b>	"
<b>4.8 - K 16</b>  4.9 mm	<b>4 x 20</b>	12.5 - 16.5	<b>145 4099</b>	B 250
	<b>4.8 x 8</b>	2.5 - 4.5	<b>145 4106</b>	B 250
	<b>4.8 x 10</b>	4.5 - 6.0	<b>145 4107</b>	"
	<b>4.8 x 12</b>	6.0 - 8.0	<b>143 3519</b>	"
	<b>4.8 x 16</b>	8.0 - 12.0	<b>145 4109</b>	"
	<b>4.8 x 20</b>	12.0 - 15.0	<b>145 4111</b>	"
	<b>4.8 x 25</b>	15.0 - 20.0	<b>143 3520</b>	"

D	D x L mm	mm	No.	
<b>5 - K 11</b>  5.1 mm  CE	<b>5 x 8</b>	2.5 - 4.5	<b>143 3521</b>	B 500
	<b>5 x 10</b>	4.5 - 6.0	<b>145 4116</b>	"
	<b>5 x 12</b>	6.0 - 8.0	<b>143 3522</b>	"
	<b>5 x 14</b>	8.0 - 10.0	<b>145 4115</b>	"
	<b>5 x 16</b>	10.0 - 12.0	<b>145 4117</b>	"
	<b>5 x 18</b>	12.0 - 14.0	<b>145 4113</b>	B 250
	<b>5 x 20</b>	14.0 - 15.0	<b>145 4118</b>	"
	<b>5 x 25</b>	15.0 - 20.0	<b>145 4119</b>	"
	<b>5 x 30</b>	20.0 - 25.0	<b>145 4120</b>	B 100
	<b>5 - K 14</b>  5.1 mm  CE	<b>5 x 8</b>	2.5 - 4.5	<b>143 3523</b>
<b>5 x 10</b>		4.5 - 6.0	<b>145 4121</b>	"
<b>5 x 12</b>		6.0 - 8.0	<b>143 3524</b>	"
<b>5 x 14</b>		8.0 - 10.0	<b>145 4122</b>	"
<b>5 x 16</b>		10.0 - 12.0	<b>145 4123</b>	"
<b>5 x 18</b>		12.0 - 14.0	<b>145 4124</b>	"
<b>5 x 20</b>		14.0 - 15.0	<b>145 4125</b>	"
<b>5 x 25</b>		15.0 - 20.0	<b>145 4126</b>	"
<b>5 x 30</b>		20.0 - 25.0	<b>145 4127</b>	B 100

## SHEAR AND TENSILE STRENGTH ALU/STEEL standard, counter sunk and large flange

### STANDARD

D mm	N 	N 	d <sub>m</sub> mm	max. d <sub>k</sub> mm
2.4	350	450	1.45	5.0
3	700	900	1.8	6.5
3.2	720	950	1.95	6.5
4 x 5-25	1,400	2,000	2.1	8.0
4 x 30-40 ■	850	1,000	2.1	8.0
4.8	1,800	2,700	2.7	9.5
5 x 6 - 35	2,000	2,800	2.7	9.5
5 x 40 - 80	1,400	2,000	2.7	9.5
6	3,100	3,800	3.2	12.0
6.4	3,400	4,600	3.65	13.0

■ Rivet body: AlMgSi

Test procedure according to DIN EN ISO 14589

### COUNTER SUNK AND LARGE FLANGE

3	700	900	1.8	6.0
4	1,400	2,000	2.1	7.5
5	2,000	2,800	2.7	9.0
3.2 K 9.5 nur Alu/Stahl	720	950	1.95	9.5
4 K 12 nur Alu/Stahl	1,400	2,000	2.1	12.0
4.8 K 16 nur Alu/Stahl	1,800	2,700	2.7	16.0
5 K 11	2,000	2,800	2.7	11.0
5 K 14	2,000	2,800	2.7	14.0





# BLIND RIVETS *ALU/STAINLESS*





## Standard Dome head

 Aluminium alloy

 Stainless steel A2



D	D x L mm	 mm	No.	
<b>3</b>  3.1 mm	<b>3 x 4</b>	0.5 - 1.5	<b>145 5036</b>	A 500
	<b>3 x 6</b>	1.5 - 3.5	<b>143 3581</b>	"
	<b>3 x 8</b>	3.5 - 5.0	<b>143 3582</b>	"
	<b>3 x 10</b>	5.0 - 7.0	<b>145 5037</b>	"
	<b>3 x 12</b>	7.0 - 9.0	<b>145 5038</b>	"
	<b>3 x 16</b>	9.0 - 13.0	<b>145 5039</b>	"
<b>3.2</b>  3.3 mm	<b>3.2 x 6</b>	1.5 - 3.5	<b>145 5049</b>	"
	<b>3.2 x 8</b>	3.5 - 5.0	<b>145 5044</b>	"
	<b>3.2 x 10</b>	5.0 - 7.0	<b>145 5045</b>	"
	<b>3.2 x 12</b>	7.0 - 9.0	<b>145 5046</b>	"
	<b>3.2 x 14</b>	9.0 - 11.0	<b>144 6433</b>	"
	<b>3.2 x 16</b>	11.0 - 13.0	<b>145 5050</b>	B 500
<b>4</b>  4.1 mm  CE	<b>4 x 6</b>	1.5 - 3.0	<b>143 3589</b>	A 500
	<b>4 x 8</b>	3.0 - 5.0	<b>143 3590</b>	"
	<b>4 x 10</b>	5.0 - 6.5	<b>143 3591</b>	"
	<b>4 x 12</b>	6.5 - 8.5	<b>143 3592</b>	B 500
	<b>4 x 14</b>	8.5 - 10.5	<b>143 3588</b>	"
	<b>4 x 16</b>	10.5 - 12.5	<b>143 3594</b>	"
	<b>4 x 18</b>	12.5 - 14.5	<b>143 3593</b>	"
	<b>4 x 20</b>	14.5 - 16.5	<b>143 3595</b>	"
	<b>4 x 25</b>	16.5 - 21.5	<b>143 3596</b>	"

D	D x L mm	 mm	No.	
<b>4.8</b>  4.9 mm  CE	<b>4.8 x 8</b>	2.5 - 4.5	<b>145 5040</b>	"
	<b>4.8 x 10</b>	4.5 - 6.0	<b>145 5041</b>	"
	<b>4.8 x 12</b>	6.0 - 8.0	<b>145 5042</b>	"
	<b>4.8 x 14</b>	8.0 - 10.0	<b>145 5043</b>	"
	<b>4.8 x 16</b>	10.0 - 12.0	<b>143 3584</b>	"
<b>5</b>  5.1 mm  CE	<b>5 x 8</b>	2.5 - 4.5	<b>143 3597</b>	B 500
	<b>5 x 10</b>	4.5 - 6.0	<b>143 3598</b>	"
	<b>5 x 12</b>	6.0 - 8.0	<b>143 3599</b>	"
	<b>5 x 14</b>	8.0 - 10.0	<b>143 3600</b>	"
	<b>5 x 16</b>	10.0 - 12.0	<b>145 5053</b>	"
	<b>5 x 18</b>	12.0 - 14.0	<b>145 5054</b>	"
	<b>5 x 20</b>	14.0 - 15.0	<b>143 3601</b>	B 250
	<b>5 x 25</b>	15.0 - 20.0	<b>145 5055</b>	"
	<b>5 x 30</b>	20.0 - 25.0	<b>145 5056</b>	A 100
	<b>5 x 35</b>	25.0 - 30.0	<b>145 5057</b>	"
<b>5 x 40</b>	30.0 - 35.0	<b>143 3602</b>	"	

Material surcharge will be added at a daily rate.

**CE:** ETA certification 13/0255 Corresponding approval documents on [www.gesipa.com](http://www.gesipa.com)  
All sizes on request – also available in bulk packs



The information on shear and tensile strength, rivet pin diameters and the maximum setting head diameters can be found on page **24**.

# BLIND RIVETS **ALU/STAINLESS**

## Large flange







Aluminium alloy

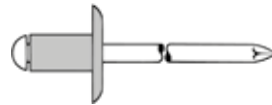

Stainless steel A2

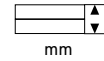

D	D x L mm	 mm	No.	
<b>5 - K 11</b>  5.1 mm <b>CE</b>	<b>5 x 8</b>	2.5 - 4.5	<b>143 3605</b>	B 500
	<b>5 x 10</b>	4.5 - 6.0	<b>143 3606</b>	"
	<b>5 x 12</b>	6.0 - 8.0	<b>143 3607</b>	"
	<b>5 x 14</b>	8.0 - 10.0	<b>143 3603</b>	"
	<b>5 x 16</b>	10.0 - 12.0	<b>143 3608</b>	"



D	D x L mm	 mm	No.	
<b>5 - K 14</b>  5.1 mm <b>CE</b>	<b>5 x 8</b>	2.5 - 4.5	<b>143 3612</b>	B 250
	<b>5 x 10</b>	4.5 - 6.0	<b>143 3613</b>	"
	<b>5 x 12</b>	6.0 - 8.0	<b>143 3614</b>	"
	<b>5 x 14</b>	8.0 - 10.0	<b>143 3619</b>	"
	<b>5 x 16</b>	10.0 - 12.0	<b>143 3615</b>	"
	<b>5 x 18</b>	12.0 - 14.0	<b>143 3620</b>	"
	<b>5 x 20</b>	14.0 - 15.0	<b>143 3616</b>	"
	<b>5 x 25</b>	15.0 - 20.0	<b>143 3617</b>	"
	<b>5 x 30</b>	20.0 - 25.0	<b>143 3618</b>	B 100

Material surcharge will be added at a daily rate.

**CE:** ETA certification 13/0255 Corresponding approval documents on [www.gesipa.com](http://www.gesipa.com)

All sizes on request – also available in bulk packs

## SHEAR AND TENSILE STRENGTH ALU/STAINLESS Standard and large flange

D mm	 N	 N	d <sub>m</sub> mm	max. d <sub>k</sub> mm
<b>3</b>	<b>700</b>	<b>900</b>	1.8	6.5
<b>3.2</b>	<b>720</b>	<b>950</b>	1.95	6.5
<b>4</b>	<b>1,400</b>	<b>2,000</b>	2.1	8.0
<b>4.8</b>	<b>1,800</b>	<b>2,700</b>	2.7	9.5
<b>5</b>	<b>2,000</b>	<b>2,800</b>	2.7	9.5
<b>5 K 11</b>	<b>2,000</b>	<b>2,800</b>	2.7	11.0
<b>5 K 14</b>	<b>2,000</b>	<b>2,800</b>	2.7	14.0

Test procedure according to DIN EN ISO 14589







# BLIND RIVETS **ALU/ALU**





## Standard Dome head

 Aluminium alloy

 Aluminium alloy



D	D x L mm	 mm	No.	
<b>3.2</b>  3.3 mm	<b>3.2 x 6.1</b>	0.8 - 3.2	<b>143 3751</b>	A 500
	<b>3.2 x 7.6</b>	3.2 - 4.8	<b>143 3752</b>	"
	<b>3.2 x 9.2</b>	4.8 - 6.4	<b>145 5510</b>	"
<b>4</b>  4.1 mm	<b>4 x 6.6</b>	1.5 - 3.2	<b>145 5513</b>	B 500
	<b>4 x 9.8</b>	3.2 - 6.4	<b>143 3753</b>	"



D	D x L mm	 mm	No.	
<b>4.8</b>  4.9 mm	<b>4.8 x 7.2</b>	1.5 - 3.2	<b>143 3755*</b>	B 500
	<b>4.8 x 10.3</b>	3.2 - 6.4	<b>143 3756</b>	"
	<b>4.8 x 13.5</b>	6.4 - 9.5	<b>145 5515</b>	"
<b>6.4</b>  6.5 mm	<b>6.4 x 12.0</b>	1.5 - 6.4	<b>143 3757</b>	B 250
	<b>6.4 x 14.9</b>	6.4 - 9.5	<b>143 3758</b>	"
	<b>6.4 x 18.1</b>	9.5 - 12.7	<b>143 3759</b>	A 100
	<b>6.4 x 24.4</b>	12.7 - 19.0	<b>143 3760</b>	"

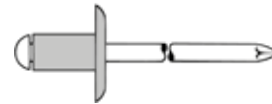

## Large flange

 Aluminium alloy

 Aluminium alloy





D	D x L mm	 mm	No.	
<b>3.2 - K 9.5</b>  3.3 mm	<b>3.2 x 9.2</b>	3.2 - 6.4	<b>145 5520*</b>	B 500

D	D x L mm	 mm	No.	
<b>4.8 - K 16</b>  4.9 mm	<b>4.8 x 10.3</b>	1.5 - 6.4	<b>145 5522</b>	B 250
	<b>4.8 x 13.5</b>	6.4 - 9.5	<b>145 5523</b>	"
	<b>4.8 x 19.9</b>	12.7 - 15.9	<b>145 5525*</b>	"

\*Clearance – only while stocks last!

## SHEAR AND TENSILE STRENGTH ALU/ALU Standard and large flange

D mm	N 	N 	d <sub>m</sub> mm	max. d <sub>k</sub> mm
<b>3.2</b>	<b>600</b>	<b>850</b>	2.05	6.5
<b>4</b>	<b>800</b>	<b>1,020</b>	2.45	8.0
<b>4.8</b>	<b>1,150</b>	<b>1,420</b>	3.0	9.5
<b>6.4</b>	<b>2,040</b>	<b>2,490</b>	3.85	12.9
<b>3.2 K 9.5</b>	<b>530</b>	<b>660</b>	1.95	9.5
<b>4.8 K 16</b>	<b>1,150</b>	<b>1,420</b>	2.9	16.0

Test procedure according to DIN EN ISO 14589







# BLIND RIVETS **STEEL/STEEL**

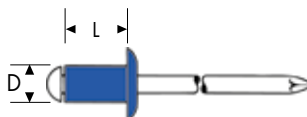



## Standard Dome head

 Steel, zinc-plated

 Steel, zinc-plated



D	D x L mm	 mm	No.	
<b>3</b>  3.1 mm	<b>3 x 5</b>	0.5 - 2.0	<b>145 4595</b>	A 500
	<b>3 x 6</b>	2.0 - 3.0	<b>143 3551</b>	"
	<b>3 x 8</b>	3.0 - 5.0	<b>143 3552</b>	"
	<b>3 x 10</b>	5.0 - 6.5	<b>145 4596</b>	"
	<b>3 x 12</b>	6.5 - 8.5	<b>145 4597</b>	"
	<b>3 x 16</b>	8.5 - 12.5	<b>145 4598</b>	B 500
<b>3.2</b>  3.3 mm	<b>3.2 x 6</b>	0.5 - 3.0	<b>145 4602</b>	A 500
	<b>3.2 x 8</b>	3.0 - 5.0	<b>143 3553</b>	"
	<b>3.2 x 10</b>	5.0 - 6.5	<b>143 3554</b>	"
	<b>3.2 x 12</b>	6.5 - 8.5	<b>145 4603</b>	"
	<b>3.2 x 16</b>	8.5 - 12.5	<b>145 4604</b>	B 500
	<b>3.2 x 18</b>	12.5 - 14.5	<b>145 4601</b>	"
	<b>3.2 x 20</b>	14.5 - 16.5	<b>145 4605</b>	"
<b>4</b>  4.1 mm	<b>4 x 6</b>	0.5 - 2.5	<b>145 4606</b>	A 500
	<b>4 x 8</b>	2.5 - 4.5	<b>143 3555</b>	"
	<b>4 x 10</b>	4.5 - 6.5	<b>143 3556</b>	B 500
	<b>4 x 12</b>	6.5 - 8.5	<b>143 3557</b>	"
	<b>4 x 16</b>	8.5 - 12.0	<b>145 4607</b>	"
	<b>4 x 18</b>	12.0 - 14.0	<b>145 4609</b>	"
	<b>4 x 20</b>	14.0 - 16.0	<b>145 4608</b>	"
	<b>4 x 25</b>	16.0 - 21.0	<b>145 4610</b>	"
<b>4.8</b>  4.9 mm	<b>4.8 x 8</b>	2.0 - 4.0	<b>143 3558</b>	B 500
	<b>4.8 x 10</b>	4.0 - 6.0	<b>143 3559</b>	"
	<b>4.8 x 12</b>	6.0 - 8.0	<b>143 3560</b>	"
	<b>4.8 x 16</b>	8.0 - 11.0	<b>143 3561</b>	"
	<b>4.8 x 20</b>	11.0 - 15.0	<b>143 3562</b>	B 250
	<b>4.8 x 25</b>	15.0 - 20.0	<b>145 4612</b>	"





D	D x L mm	 mm	No.	
<b>5</b>  5.1 mm	<b>5 x 8</b>	2.0 - 4.0	<b>145 4613</b>	B 500
	<b>5 x 10</b>	4.0 - 6.0	<b>145 4614</b>	"
	<b>5 x 12</b>	6.0 - 8.0	<b>145 4615</b>	"
	<b>5 x 16</b>	8.0 - 11.0	<b>145 4617</b>	"
	<b>5 x 20</b>	11.0 - 15.0	<b>145 4619</b>	B 250
	<b>5 x 25</b>	15.0 - 20.0	<b>145 4620</b>	"
	<b>5 x 30</b>	20.0 - 25.0	<b>145 4621</b>	A 100
	<b>5 x 35</b>	25.0 - 30.0	<b>145 4622</b>	"
	<b>5 x 40</b>	30.0 - 34.0	<b>145 4623</b>	B 100
	<b>5 x 45</b>	34.0 - 39.0	<b>145 4624</b>	B 100
	<b>5 x 50</b>	39.0 - 44.0	<b>145 4625</b>	B 100
<b>6</b>  6.1 mm	<b>6 x 10</b>	2.5 - 4.5	<b>145 4626</b>	B 250
	<b>6 x 12</b>	4.5 - 6.5	<b>145 4627</b>	"
	<b>6 x 14</b>	6.5 - 8.5	<b>145 4628</b>	"
	<b>6 x 16</b>	8.5 - 10.5	<b>145 4629</b>	"
	<b>6 x 20</b>	10.5 - 14.5	<b>145 4630</b>	"
<b>6.4</b>  6.5 mm	<b>6.4 x 8</b>	1.0 - 3.0	<b>143 3563</b>	B 250
	<b>6.4 x 12</b>	3.0 - 6.0	<b>143 3564</b>	"
	<b>6.4 x 16</b>	6.0 - 9.0	<b>143 3565</b>	"
	<b>6.4 x 20</b>	9.0 - 13.0	<b>143 3566</b>	"
	<b>6.4 x 25</b>	13.0 - 17.0	<b>143 3567</b>	"

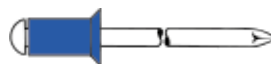

# BLIND RIVETS **STEEL/STEEL**

## Countersunk (120°)

 Steel, zinc-plated  Steel, zinc-plated



D	D x L mm	 mm	No.	
<b>3</b>  3.1 mm	<b>3 x 6</b>	1.0 - 3.0	<b>145 4633</b>	A 500
	<b>3 x 8</b>	3.0 - 5.0	<b>145 4634</b>	"
	<b>3 x 10</b>	5.0 - 6.5	<b>145 4635</b>	"
	<b>3 x 12</b>	6.5 - 8.5	<b>145 4636</b>	"
<b>4</b>  4.1 mm	<b>4 x 6</b>	1.5 - 2.5	<b>145 4637</b>	A 500
	<b>4 x 8</b>	2.5 - 4.5	<b>145 4638</b>	"
	<b>4 x 10</b>	4.5 - 6.5	<b>145 4639</b>	B 500
	<b>4 x 12</b>	6.5 - 8.5	<b>145 4640</b>	"
	<b>4 x 16</b>	8.5 - 12.0	<b>145 4641</b>	"

D	D x L mm	 mm	No.	
<b>5</b>  5.1 mm	<b>5 x 8</b>	2.0 - 4.0	<b>145 4644</b>	B 500
	<b>5 x 10</b>	4.0 - 6.0	<b>145 4645</b>	"
	<b>5 x 12</b>	6.0 - 8.0	<b>145 4646</b>	"
	<b>5 x 16</b>	9.5 - 11.0	<b>145 4647</b>	"
	<b>5 x 20</b>	11.0 - 15.0	<b>145 4648</b>	B 250
	<b>5 x 25</b>	15.0 - 20.0	<b>145 4649</b>	"

## SHEAR AND TENSILE STRENGTH STEEL/STEEL Standard and countersunk

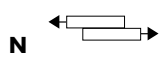
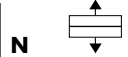
D mm	 N	 N	d <sub>m</sub> mm	max. d <sub>k</sub> mm
<b>STANDARD</b>				
<b>3</b>	<b>1,000</b>	<b>1,300</b>	1.95	6.5
<b>3.2</b>	<b>1,200</b>	<b>1,500</b>	2.0	6.5
<b>4</b>	<b>2,000</b>	<b>2,500</b>	2.5	8.0
<b>4.8</b>	<b>2,900</b>	<b>4,000</b>	3.0	9.5
<b>5</b>	<b>3,100</b>	<b>4,400</b>	3.0	9.5
<b>6</b>	<b>4,400</b>	<b>6,000</b>	3.65	12.0
<b>6.4</b>	<b>4,900</b>	<b>6,800</b>	3.85	13.0
<b>COUNTERSUNK</b>				
<b>3</b>	<b>1,000</b>	<b>1,300</b>	1.95	6.0
<b>4</b>	<b>2,000</b>	<b>2,500</b>	2.5	7.5
<b>5</b>	<b>3,100</b>	<b>4,400</b>	3.0	9.0



Test procedure according to DIN EN ISO

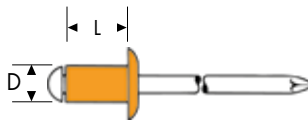

# BLIND RIVETS **COPPER/STEEL**

## Standard Dome head

 Copper  Steel, zinc-plated



D	D x L mm	 mm	No.	
<b>3</b>  3.1 mm	<b>3 x 4</b>	0.5 - 1.5	<b>145 5279</b>	A 500
	<b>3 x 6</b>	1.5 - 3.0	<b>143 3655</b>	"
	<b>3 x 8</b>	3.0 - 5.0	<b>143 3656</b>	"
	<b>3 x 10</b>	5.0 - 7.0	<b>143 3657</b>	"
	<b>3 x 12</b>	7.0 - 9.0	<b>145 5280*</b>	"

D	D x L mm	 mm	No.	
<b>4</b>  4.1 mm	<b>4 x 6</b>	0.5 - 3.5	<b>143 3658</b>	A 500
	<b>4 x 8</b>	3.5 - 4.5	<b>145 5281</b>	"
	<b>4 x 10</b>	4.5 - 6.5	<b>145 5282</b>	"



\*Clearance – only while stocks last!



# BLIND RIVETS **COPPER/STEEL**

## Standard Dome head



 Copper  Bronze



D	D x L mm	 mm	No.	
<b>3</b>  3.1 mm	<b>3 x 4</b>	0.5 - 1.5	<b>145 5289</b>	A 500
	<b>3 x 6</b>	1.5 - 3.0	<b>145 5290</b>	"
	<b>3 x 8</b>	3.0 - 5.0	<b>143 3661</b>	"
	<b>3 x 10</b>	5.0 - 7.0	<b>145 5291</b>	"

D	D x L mm	 mm	No.	
<b>4</b>  4.1 mm	<b>4 x 6</b>	0.5 - 3.5	<b>145 5293</b>	A 500
	<b>4 x 8</b>	3.5 - 4.5	<b>145 5294</b>	"
	<b>4 x 10</b>	4.5 - 6.5	<b>145 5295</b>	"

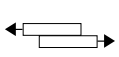
## SHEAR AND TENSILE STRENGTH COPPER/STEEL and COPPER/BRONZE

D mm	N 	N 	$d_m$ mm	max. $d_k$ mm
<b>3</b>	<b>800</b>	<b>1,000</b>	1.8	6.5
<b>4</b>	<b>1,500</b>	<b>2,200</b>	2.1	8.0

Test procedure according to DIN EN ISO 14589

# BLIND RIVETS **A2 STAINLESS STEEL**



## Standard Dome head

Stainless steel A2  
– Nr. 1.4567

Stainless steel A2

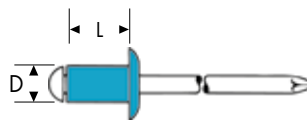

D	D x L mm	 mm	No.	
<b>3</b>  3.1 mm	<b>3 x 6</b>	1.0 - 3.0	<b>143 3621</b>	A 500
	<b>3 x 8</b>	3.0 - 5.0	<b>143 3622</b>	"
	<b>3 x 10</b>	5.0 - 6.5	<b>145 5157</b>	"
	<b>3 x 12</b>	6.5 - 8.5	<b>145 5158</b>	"
	<b>3 x 14</b>	8.5 - 10.5	<b>145 5159</b>	"
	<b>3 x 16</b>	10.5 - 12.5	<b>145 5160</b>	"
<b>3.2</b>  3.3 mm	<b>3.2 x 6</b>	1.0 - 3.0	<b>143 3623</b>	A 500
	<b>3.2 x 8</b>	3.0 - 5.0	<b>143 3624</b>	"
	<b>3.2 x 10</b>	5.0 - 6.5	<b>143 3625</b>	"
	<b>3.2 x 12</b>	6.5 - 8.5	<b>143 3626</b>	"
	<b>3.2 x 16</b>	8.5 - 12.5	<b>145 5161</b>	"
<b>4</b>  4.1 mm  CE	<b>4 x 6</b>	1.0 - 2.5	<b>143 3627</b>	A 500
	<b>4 x 8</b>	2.5 - 4.5	<b>143 3628</b>	"
	<b>4 x 10</b>	4.5 - 6.5	<b>143 3629</b>	B 500
	<b>4 x 12</b>	6.5 - 8.5	<b>143 3630</b>	"
	<b>4 x 14</b>	8.5 - 10.5	<b>143 3633</b>	"
	<b>4 x 16</b>	10.5 - 12.0	<b>143 3631</b>	"
	<b>4 x 20</b>	12.0 - 16.0	<b>143 3632</b>	"
	<b>4 x 25</b>	16.0 - 21.0	<b>145 5163</b>	"

D	D x L mm	 mm	No.	
<b>4.8</b>  4.9 mm  CE	<b>4.8 x 6</b>	1.5 - 3.0	<b>145 5164</b>	B 500
	<b>4.8 x 8</b>	2.0 - 4.0	<b>143 3634</b>	"
	<b>4.8 x 10</b>	4.0 - 6.0	<b>143 3635</b>	"
	<b>4.8 x 12</b>	6.0 - 8.0	<b>143 3636</b>	"
	<b>4.8 x 14</b>	8.0 - 9.5	<b>145 5165</b>	"
	<b>4.8 x 16</b>	9.5 - 11.0	<b>143 3637</b>	"
	<b>4.8 x 20</b>	11.0 - 15.0	<b>143 3638</b>	B 250
	<b>4.8 x 25</b>	15.0 - 20.0	<b>145 5166</b>	B 250
	<b>4.8 x 30</b>	20.0 - 25.0	<b>143 3639</b>	A 100
	<b>5</b>  5.1 mm	<b>5 x 8</b>	2.0 - 4.0	<b>145 5168</b>
<b>5 x 10</b>		4.0 - 6.0	<b>145 5169</b>	"
<b>5 x 12</b>		6.0 - 8.0	<b>145 5170</b>	"
<b>5 x 14</b>		8.0 - 9.5	<b>145 5171</b>	"
<b>5 x 16</b>		9.5 - 11.0	<b>145 5172</b>	"
<b>5 x 20</b>		11.0 - 15.0	<b>143 3646</b>	B 250
<b>5 x 25</b>		15.0 - 20.0	<b>143 3647</b>	"
<b>5 x 30</b>		20.0 - 25.0	<b>143 3648</b>	A 100
<b>5 x 35</b>		25.0 - 30.0	<b>145 5173</b>	"
<b>5 x 40</b>		30.0 - 34.0	<b>143 3649</b>	"

Material surcharge will be added at a daily rate.

**CE:** ETA certification 13/0255 Corresponding approval documents on [www.gesipa.com](http://www.gesipa.com)

All sizes on request – also available in bulk packs

## Countersunk (120°)

Stainless steel A2  
– Nr. 1.4567

Stainless steel A2



D	D x L mm	 mm	No.	
<b>3</b>  3.1 mm	<b>3 x 6</b>	1.5 - 3.0	<b>145 5174</b>	A 500
	<b>3 x 8</b>	3.0 - 5.0	<b>143 3650</b>	"
	<b>3 x 10</b>	5.0 - 6.5	<b>145 5175</b>	"
<b>3.2</b>  3.3 mm	<b>3.2 x 6</b>	1.5 - 3.0	<b>145 5177</b>	A 500
	<b>3.2 x 8</b>	3.0 - 5.0	<b>145 5178</b>	"
	<b>3.2 x 10</b>	5.0 - 6.5	<b>145 5179</b>	"

D	D x L mm	 mm	No.	
<b>4</b>  4.1 mm	<b>4 x 8</b>	1.5 - 4.5	<b>145 5181</b>	A 500
	<b>4 x 10</b>	4.5 - 6.5	<b>143 3651</b>	B 500
	<b>4 x 12</b>	6.5 - 8.5	<b>143 3652</b>	"
<b>4.8</b>  4.9 mm	<b>4.8 x 10</b>	4.0 - 6.0	<b>145 5183</b>	"
	<b>4.8 x 12</b>	6.0 - 8.0	<b>145 5184</b>	"
<b>5</b>  5.1 mm	<b>5 x 8</b>	2.0 - 4.0	<b>145 5185</b>	B 500
	<b>5 x 10</b>	4.0 - 6.0	<b>145 5186</b>	"
	<b>5 x 12</b>	6.5 - 8.5	<b>143 3653</b>	"



The information on shear and tensile strength, rivet pin diameters and the maximum setting head diameters can be found on **page 30**.

Material surcharge will be added at a daily rate.

# BLIND RIVETS **A2 STAINLESS STEEL**





## Large flange

 Stainless steel A2  
– Nr. 1.4567

 Stainless steel A2





D	D x L mm	 mm	No.	
<b>4.8 - K 15</b>  4.9 mm <b>CE</b>	<b>4.8 x 14</b>	8.0 - 9.5	<b>143 3640</b>	B 250
	<b>4.8 x 16</b>	9.5 - 11.0	<b>143 3641</b>	"
	<b>4.8 x 20</b>	11.0 - 15.0	<b>143 3642</b>	"
	<b>4.8 x 25</b>	15.0 - 20.0	<b>143 3643</b>	B 200
	<b>4.8 x 30</b>	20.0 - 25.0	<b>143 3644</b>	B 100

Material surcharge will be added at a daily rate.

**CE:** ETA certification 13/0255 Corresponding approval documents on [www.gesipa.com](http://www.gesipa.com)

All sizes on request – also available in bulk packs

## SHEAR AND TENSILE STRENGTH A2 STAINLESS STEEL Standard, countersunk and large flange

D mm	 N	 N	d <sub>m</sub> mm	max. d <sub>k</sub> mm
<b>STANDARD / COUNTERSUNK</b>				
<b>3</b>	<b>1,600</b>	<b>2,000</b>	2.0	6.5
<b>3.2</b>	<b>1,900</b>	<b>2,500</b>	2.0	6.5
<b>4</b>	<b>2,700</b>	<b>3,600</b>	2.6	8.0
<b>4 x 20 - 25 ■</b>	<b>3,800</b>	<b>4,500</b>	2.6	8.0
<b>4.8</b>	<b>4,000</b>	<b>5,000</b>	3.2	9.5
<b>5</b>	<b>4,700</b>	<b>5,900</b>	3.2	9.5
<b>5 x 40 ■</b>	<b>5,900</b>	<b>7,200</b>	3.2	9.5
<b>LARGE FLANGE</b>				
<b>4.8</b>	<b>4,000</b>	<b>5,000</b>	3.2	15.0

■ Hollow rivet stainless steel A2 tube, material no. 1.4301 Test procedure according to DIN EN ISO 14589

# BLIND RIVETS **A4 STAINLESS STEEL**



## Standard Dome head

Stainless steel A4 – Nr. 1.4578

Stainless steel A4

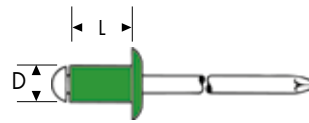

D	D x L mm	 mm	No.	
<b>3</b>  3.1 mm	<b>3 x 6</b>	1.0 - 3.0	<b>145 5530</b>	A 500
	<b>3 x 8</b>	3.0 - 5.0	<b>145 5531</b>	"
	<b>3 x 10</b>	5.0 - 6.5	<b>145 5532</b>	"
	<b>3 x 12</b>	6.5 - 8.5	<b>145 5533</b>	"
<b>3.2</b>  3.3 mm	<b>3.2 x 6</b>	1.0 - 3.0	<b>143 3761</b>	A 500
	<b>3.2 x 8</b>	3.0 - 5.0	<b>143 3762</b>	"
	<b>3.2 x 10</b>	5.0 - 6.5	<b>143 3763</b>	"
<b>4</b>  4.1 mm  CE	<b>4 x 6</b>	1.0 - 2.5	<b>145 5534</b>	A 500
	<b>4 x 8</b>	2.5 - 4.5	<b>143 3764</b>	"
	<b>4 x 10</b>	4.5 - 6.5	<b>143 3765</b>	B 500
	<b>4 x 12</b>	6.5 - 8.5	<b>143 3766</b>	"
	<b>4 x 14</b>	8.5 - 10.5	<b>145 5536</b>	"
	<b>4 x 16</b>	10.5 - 12.0	<b>143 3767</b>	"

D	D x L mm	 mm	No.	
<b>4.8</b>  4.9 mm  CE	<b>4.8 x 8</b>	3.0 - 4.5	<b>143 3769</b>	"
	<b>4.8 x 10</b>	4.5 - 6.0	<b>143 3770</b>	"
	<b>4.8 x 12</b>	6.0 - 7.5	<b>143 3777</b>	"
	<b>4.8 x 16</b>	9.5 - 11.0	<b>143 3772</b>	"
	<b>4.8 x 20</b>	11.0 - 15.0	<b>143 3773</b>	B 250
<b>5</b>  5.1 mm	<b>5 x 8</b>	2.0 - 4.0	<b>145 5537</b>	B 500
	<b>5 x 10</b>	4.0 - 6.0	<b>143 3778</b>	"
	<b>5 x 12</b>	6.0 - 8.0	<b>143 3779</b>	"
	<b>5 x 16</b>	8.0 - 11.0	<b>143 3781</b>	"
	<b>5 x 20</b>	11.0 - 15.0	<b>145 5538</b>	B 250
	<b>5 x 25</b>	15.0 - 20.0	<b>143 3782</b>	"
	<b>5 x 30</b>	20.0 - 25.0	<b>143 3783</b>	A 100
	<b>5 x 35</b>	25.0 - 30.0	<b>143 3784</b>	"

Material surcharge will be added at a daily rate.

## Large flange

Stainless steel A4 – Nr. 1.4578

Stainless steel A4



D	D x L mm	 mm	No.	
<b>4.8 - K 15</b>  4.9 mm  CE	<b>4.8 x 14</b>	8.0 - 9.5	<b>143 3785</b>	B 250
	<b>4.8 x 16</b>	9.5 - 11.0	<b>143 3786</b>	"
	<b>4.8 x 20</b>	11.0 - 15.0	<b>143 3787</b>	"
	<b>4.8 x 25</b>	15.0 - 20.0	<b>143 3788</b>	B 200
	<b>4.8 x 30</b>	20.0 - 25.0	<b>143 3789</b>	B 100
	<b>4.8 x 35</b>	25.0 - 30.0	<b>143 3790</b>	"

Material surcharge will be added at a daily rate.

**CE:** ETA certification 13/0255 Corresponding approval documents on [www.gesipa.com](http://www.gesipa.com)  
All sizes on request – also available in bulk packs

## SHEAR AND TENSILE STRENGTH A4 STAINLESS STEEL Standard and large flange

D mm	Art	N	N	d <sub>m</sub> mm	max. d <sub>k</sub> mm
<b>3</b>	Standard	<b>1,600</b>	<b>2,000</b>	2.0	6.5
<b>3.2</b>	Standard	<b>1,900</b>	<b>2,500</b>	2.0	6.5
<b>4</b>	Standard	<b>2,700</b>	<b>3,600</b>	2.6	8.0
<b>4.8</b>	Standard	<b>4,000</b>	<b>5,000</b>	3.2	9.5
<b>4.8</b>	Large flange	<b>4,000</b>	<b>5,000</b>	3.2	15.0
<b>5</b>	Standard	<b>4,700</b>	<b>5,900</b>	3.2	9.5

# BLIND RIVETS **STINOX**

## Standard Dome head







Stainless steel A2  
– Nr. 1.4567

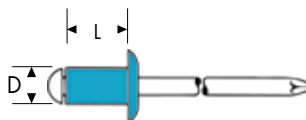



Steel, zinc-plated



D	D x L mm	 mm	No.	
<b>3</b>  3.1 mm	<b>3 x 6</b>	1.0 - 3.0	<b>145 5297</b>	A 500
	<b>3 x 8</b>	3.0 - 5.0	<b>145 5298</b>	"
<b>4</b>  4.1 mm	<b>4 x 8</b>	2.5 - 4.5	<b>145 5304</b>	"
	<b>4 x 10</b>	4.5 - 6.5	<b>145 5305</b>	B 500
	<b>4 x 12</b>	6.5 - 8.5	<b>145 5306</b>	"
	<b>4 x 16</b>	8.5 - 12.0	<b>145 5307</b>	"
<b>5</b>  5.1 mm	<b>5 x 8</b>	2.0 - 4.0	<b>145 5311</b>	B 500
	<b>5 x 10</b>	4.0 - 6.0	<b>145 5312</b>	"

Material surcharge will be added at a daily rate.

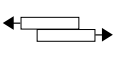
## SHEAR AND TENSILE STRENGTH Standard

D mm	N 	N 	d <sub>m</sub> mm	max. d <sub>k</sub> mm
<b>3</b>	<b>1,600</b>	<b>2,000</b>	2.0	6.5
<b>4</b>	<b>2,700</b>	<b>3,600</b>	2.6	8.0
<b>5</b>	<b>4,700</b>	<b>5,900</b>	3.2	9.5

Test procedure according to DIN EN ISO 14589



# POLYGRIP® – A MOST VERSATILE SMALL FELLOW

**GESIPA®-PolyGrip® – Favorite for difficult and demanding applications for all kinds of materials in industrial environment**



The GESIPA® PolyGrip® range of blind rivets, originally meant to be only a multigrip rivet has meanwhile shown other multiple talents. This makes it a favourite choice for difficult and demanding applications in industrial environment. Whether in aluminium, steel or stainless steel, outdoor or indoor, with hard or soft application materials, critical hole diameters and tolerances, when nothing seems to work properly, GESIPA® PolyGrip® will usually save the day.

## MAIN FEATURES

### • Large grip range:

One single PolyGrip® blind rivet can replace up to five different sizes of standard DIN blind rivets

### Your benefits:

- > Type simplification
- > Limited type variety for reduced stocks
- > Lower risk of confusion therefore fewer mistakes in production

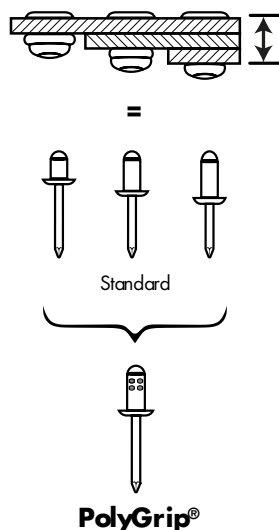

• **Outstanding hole filling capability:** The rivet body expands radially during the setting process and compensates hole tolerances, centering deviations and differences in diameter, thus always building up a playfree and tight joint.

• **Safe rest mandrel locking:** PolyGrip® blind rivets neither generate rattling noises due to free moving rest mandrels nor do they allow the risk of loss of the rest mandrel.

• **Splash waterproof** are the PolyGrip® blind rivets under certain conditions too. Hole filling and rest mandrel locking make of them a real alternative to closed end rivets when it is essential to prevent water flowing through the whole joint and not only through the rivet body.

• **A large closing head:** for a high tensile and unbuttoning resistance.



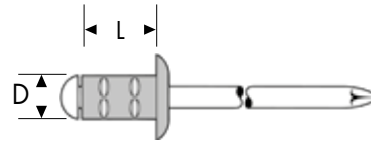

## Alu/steel

Standard







(Dome head)



Aluminium alloy



Steel, zinc-plated

D	D x L mm	 mm	No.	
<b>3.2</b>  3.3 mm	<b>3.2 x 8</b>	0.5 - 5.0	<b>143 3822</b>	B 1,000
	<b>3.2 x 9.5</b>	1.5 - 6.5	<b>143 3823</b>	"
	<b>3.2 x 11</b>	3.0 - 8.0	<b>143 3824</b>	"
<b>4.0</b>  4.1 mm	<b>4 x 10</b>	0.5 - 6.5	<b>143 3826</b>	B 500
	<b>4 x 13</b>	3.5 - 9.5	<b>143 3827</b>	"
	<b>4 x 17</b>	7.0 - 13.0	<b>143 3828</b>	"
<b>4.8</b>  4.9 mm	<b>4.8 x 10</b>	0.5 - 6.5	<b>143 3831</b>	B 500
	<b>4.8 x 15</b>	4.5 - 11.0	<b>143 3832</b>	"
	<b>4.8 x 17</b>	6.5 - 13.0	<b>143 3833</b>	"
	<b>4.8 x 25</b>	11.0 - 19.5	<b>143 3838</b>	B 250
	<b>4.8 x 30</b>	16.0 - 24.0	<b>143 3839</b>	"
<b>6.4</b>  6.5 mm	<b>6.4 x 15</b>	1.5 - 9.0	<b>143 3841</b>	B 250
	<b>6.4 x 20</b>	6.0 - 14.0	<b>143 3842</b>	"
	<b>6.4 x 25</b>	10.0 - 18.0	<b>143 3843</b>	"

## Alu/steel





Countersunk (120°)



Aluminium alloy



Steel, zinc-plated

D	D x L mm	 mm	No.	
<b>3.2</b>  3.3 mm	<b>3.2 x 6</b>	1.0 - 3.0	<b>145 0404</b>	B 1,000
	<b>3.2 x 10</b>	4.0 - 7.0	<b>145 0405</b>	"
<b>4.0</b>  4.1 mm	<b>4 x 6</b>	1.5 - 3.5	<b>145 0406</b>	B 500
	<b>4 x 12</b>	3.5 - 8.5	<b>144 6470</b>	"
<b>4.8</b>  4.9 mm	<b>4.8 x 10</b>	2.0 - 5.0	<b>145 0407</b>	B 500
	<b>4.8 x 15</b>	5.0 - 11.0	<b>144 6471</b>	"

## Alu/steel





Large flange



Aluminium alloy



Steel, zinc-plated

D	D x L mm	 mm	No.	
<b>3.2 - K 9.5</b>  3.3 mm	<b>3.2 x 8</b>	0.5 - 5.0	<b>143 3825</b>	B 1,000
	<b>3.2 x 9.5</b>	1.5 - 6.5	<b>145 5675</b>	"
	<b>3.2 x 11</b>	3.0 - 8.0	<b>145 5676</b>	"
<b>4.0 - K 12</b>  4.1 mm	<b>4 x 10</b>	0.5 - 6.5	<b>143 3829</b>	B 500
	<b>4 x 13</b>	3.5 - 9.5	<b>143 3830</b>	"
	<b>4 x 17</b>	7.0 - 13.0	<b>143 3837</b>	"
<b>4.8 - K 16</b>  4.9 mm	<b>4.8 x 10</b>	0.5 - 6.5	<b>143 3834</b>	B 250
	<b>4.8 x 15</b>	4.5 - 11.0	<b>143 3835</b>	"
	<b>4.8 x 17</b>	6.5 - 13.0	<b>143 3836</b>	"
	<b>4.8 x 25</b>	11.0 - 19.5	<b>143 3840</b>	B 100
	<b>4.8 x 30</b>	16.0 - 24.0	<b>145 5677</b>	"



## Alu/stainless Standard







(Dome head)



Aluminium alloy



Stainless steel A2

D	D x L mm	 mm	No.	
<b>3.2</b>  3.3 mm	<b>3.2 x 8</b>	0.5 - 5.0	<b>143 3883</b>	B 1,000
	<b>3.2 x 9.5</b>	1.5 - 6.5	<b>143 3884</b>	"
	<b>3.2 x 11</b>	3.0 - 8.0	<b>143 3885</b>	"
<b>4.0</b> <b>CE</b>  4.1 mm	<b>4 x 10</b>	0.5 - 6.5	<b>143 3887</b>	B 500
	<b>4 x 13</b>	3.5 - 9.5	<b>143 3888</b>	"
	<b>4 x 17</b>	7.0 - 13.0	<b>143 3889</b>	"
<b>4.8</b> <b>CE</b>  4.9 mm	<b>4.8 x 10</b>	0.5 - 6.5	<b>143 3892</b>	B 500
	<b>4.8 x 15</b>	4.5 - 11.0	<b>143 3893</b>	"
	<b>4.8 x 17</b>	6.5 - 13.0	<b>143 3894</b>	"
	<b>4.8 x 25</b>	11.0 - 19.5	<b>143 3895</b>	B 250
	<b>4.8 x 30</b>	16.0 - 24.0	<b>143 3896</b>	"
<b>6.4</b>  6.5 mm	<b>6.4 x 15</b>	1.5 - 9.0	<b>143 3902</b>	B 250
	<b>6.4 x 20</b>	6.0 - 14.0	<b>143 3903</b>	"
	<b>6.4 x 25</b>	10.0 - 18.0	<b>143 3904</b>	"

Material surcharge will be added at a daily rate.





## Alu/stainless Large flange



Aluminium alloy



Stainless steel A2

D	D x L mm	 mm	No.	
<b>3.2 - CE</b> <b>K 9.5</b>  3.3 mm	<b>3.2 x 8</b>	0.5 - 5.0	<b>145 6032</b>	B 1,000
	<b>3.2 x 9.5</b>	1.5 - 6.5	<b>143 3886</b>	"
<b>4.0 - CE</b> <b>K 12</b>  4.1 mm	<b>4 x 10</b>	0.5 - 6.5	<b>143 3890</b>	B 500
	<b>4 x 13</b>	3.5 - 9.5	<b>143 3891</b>	"
	<b>4 x 17</b>	7.0 - 13.0	<b>145 6034</b>	"
<b>4.8</b> <b>- K 16</b>  4.9 mm	<b>4.8 x 10</b>	0.5 - 6.5	<b>143 3897</b>	B 250
	<b>4.8 x 15</b>	4.5 - 11.0	<b>143 3898</b>	"
	<b>4.8 x 17</b>	6.5 - 13.0	<b>143 3899</b>	"
	<b>4.8 x 25</b>	11.0 - 19.5	<b>143 3900</b>	B 100
	<b>4.8 x 30</b>	16.0 - 24.0	<b>143 3901</b>	"

Material surcharge will be added at a daily rate.

**CE:** ETA certification 13/0255 Corresponding approval documents on [www.gesipa.com](http://www.gesipa.com)  
All sizes on request – also available in bulk packs

Under certain conditions all  
GESIPA® PolyGrip® blind  
rivets are splash waterproof.



**38**

The information on shear  
and tensile strength, rivet pin  
diameters and the maximum  
setting head diameters can  
be found on **page 38**.

## Steel/steel

Standard







(Dome head)



Steel, zinc-plated



SSteel, zinc-plated

D	D x L mm	 mm	No.	
<b>3.2</b>  3.3 mm	<b>3.2 x 8</b>	1.0 - 5.0	<b>143 3866</b>	B 1,000
	<b>3.2 x 9.5</b>	2.0 - 6.5	<b>143 3867</b>	"
	<b>3.2 x 11</b>	3.0 - 8.0	<b>143 3868</b>	"
<b>4.0</b>  4.1 mm	<b>4 x 10</b>	1.5 - 6.5	<b>143 3869</b>	B 500
	<b>4 x 13</b>	4.5 - 9.0	<b>143 3870</b>	"
	<b>4 x 17</b>	8.5 - 13.0	<b>143 3871</b>	"
<b>4.8</b>  4.9 mm	<b>4.8 x 10</b>	1.5 - 6.5	<b>143 3873</b>	B 500
	<b>4.8 x 15</b>	6.0 - 11.0	<b>143 3874</b>	B 250
	<b>4.8 x 17</b>	8.5 - 13.0	<b>143 3875</b>	"
<b>6.4</b>  6.5 mm	<b>6.4 x 15</b>	2.0 - 8.0	<b>143 3877</b>	B 250
	<b>6.4 x 20</b>	5.0 - 13.0	<b>143 3878</b>	"
	<b>6.4 x 25</b>	10.0 - 18.0	<b>143 3879</b>	B 200

## Steel/steel





Countersunk (120°)



Steel, zinc-plated



Steel, zinc-plated

D	D x L mm	 mm	No.	
<b>3.2</b>  3.3 mm	<b>3.2 x 6</b>	1.0 - 3.0	<b>145 0435</b>	B 1,000
	<b>3.2 x 10</b>	3.0 - 7.0	<b>145 0436</b>	"
<b>4.0</b>  4.1 mm	<b>4 x 6</b>	1.5 - 3.5	<b>145 0437</b>	B 500
	<b>4 x 12</b>	3.5 - 8.5	<b>144 6482</b>	"
<b>4.8</b>  4.9 mm	<b>4.8 x 10</b>	2.0 - 6.0	<b>144 6483</b>	B 500
	<b>4.8 x 15</b>	5.5 - 11.0	<b>144 6484</b>	"

## Steel/steel





Large flange



Steel, zinc-plated



Steel, zinc-plated

D	D x L mm	 mm	No.	
<b>3.2 - K 9.5</b>  3.3 mm	<b>3.2 x 8</b>	1.0 - 5.0	<b>145 5972</b>	B 1,000
	<b>3.2 x 9.5</b>	2.0 - 6.5	<b>145 5973</b>	"
	<b>3.2 x 11</b>	3.0 - 8.0	<b>145 5974</b>	"
<b>4.0 - K 12</b>  4.1 mm	<b>4 x 10</b>	1.5 - 6.5	<b>143 3872</b>	B 500
	<b>4 x 13</b>	4.5 - 9.0	<b>145 5975</b>	"
	<b>4 x 17</b>	8.5 - 13.0	<b>145 5976</b>	"
<b>4.8 - K 16</b>  4.9 mm	<b>4.8 x 10</b>	1.5 - 6.5	<b>143 3876</b>	B 250
	<b>4.8 x 15</b>	6.0 - 11.0	<b>145 5977</b>	"
	<b>4.8 x 17</b>	8.5 - 13.0	<b>145 5978</b>	"

## A2 Stainless steel







Standard

Dome head

 Stainless steel A2 - no. 1.4567

 Stainless steel A2



D	D x L mm	 mm	No.	
<b>3.2</b>  3.3 mm	<b>3.2 x 8</b>	1.0 - 5.0	<b>143 3909</b>	B 1,000
	<b>3.2 x 9.5</b>	2.0 - 6.0	<b>145 6288</b>	"
	<b>3.2 x 11</b>	3.0 - 8.0	<b>143 3910</b>	"
<b>4.0</b>  4.1 mm	<b>4 x 10</b>	1.0 - 6.5	<b>143 3911</b>	B 500
	<b>4 x 13</b>	3.0 - 8.0	<b>143 3912</b>	"
	<b>4 x 17</b>	7.0 - 11.0	<b>143 3913</b>	"
<b>4.8</b> <b>CE</b>  4.9 mm	<b>4.8 x 10</b>	1.0 - 6.5	<b>143 3914</b>	B 500
	<b>4.8 x 15</b>	5.0 - 10.0	<b>143 3915</b>	"
	<b>4.8 x 17</b>	8.0 - 12.0	<b>143 3916</b>	"
<b>6.4</b>  6.5 mm	<b>6.4 x 13</b>	2.0 - 6.5	<b>143 3918</b>	B 250
	<b>6.4 x 15</b>	3.5 - 8.5	<b>143 3917</b>	"
	<b>6.4 x 20</b>	7.0 - 12.5	<b>143 3919</b>	B 200

Material surcharge will be added at a daily rate.

**CE:** ETA certification 13/0255 Corresponding approval documents on [www.gesipa.com](http://www.gesipa.com)

All sizes on request – also available in bulk packs

## A4 Stainless steel





Standard

Dome head

 Stainless steel A4 - no. 1.4578

 Stainless steel A4



D	D x L mm	 mm	No.	
<b>3.2</b>  3.3 mm	<b>3.2 x 11</b>	3.0 - 8.0	<b>143 3921</b>	B 1,000
	<b>4.0</b>  4.1 mm	1.0 - 6.5	<b>143 3922</b>	B 500
<b>4.8</b>  4.9 mm	<b>4.8 x 10</b>	1.0 - 6.5	<b>143 3923</b>	"
	<b>4.8 x 15</b>	5.0 - 10.0	<b>143 3924</b>	"

Material surcharge will be added at a daily rate.





The information on shear and tensile strength, rivet pin diameters and the maximum setting head diameters can be found on **page 38**.

# POLYGRIP® Shear and tensile strength

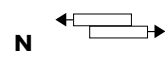
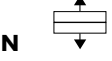
## SHEAR AND TENSILE STRENGTH POLYGRIP®

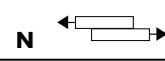
D mm	 N	 N	d <sub>m</sub> mm	max. d <sub>k</sub> Standard mm	max. d <sub>k</sub> Großkopf mm
<b>ALU/STEEL AND ALU/STAINLESS STEEL</b>					
3.2	720	1,050	1.8	6.5	9,5
4.0	1,060	1,680	2.3	8.0	12.0
4.8	1,500	2,300	2.7	9.5	16.0
6.4	2,800	4,000	3.65	13.0	-
<b>STEEL/STEEL</b>					
3.2	1,200	1,600	2.1	6.5	9,5
4.0	1,650	2,400	2.6	8.0	12.0
4.8	2,400	3,200	3.2	9.5	16.0
6.4	4,000	6,100	4.25	13.0	-

D mm	 N	 N	d <sub>m</sub> mm	max. d <sub>k</sub> Standard mm
<b>STAINLESS STEEL A2</b>				
3.2	1,450	2,300	2.2	6.5
4.0	2,650	3,600	2.7	8.0
4.8	4,000	5,000	3.2	9.5
6.4	7,800	8,800	4.25	13.0
<b>STAINLESS STEEL A4</b>				
3.2	1,450	2,300	2.2	6.5
4.0	2,650	3,600	2.7	8.0
4.8	4,000	5,000	3.2	9.5

Test procedure according to DIN EN ISO 14589

# COLOURED BLIND RIVETS

Coloured blind rivets, visually appealing with additional corrosion protection



GESIPA® blind rivets are also available in colour to match the application. To guarantee the best possible durability the hollow rivets are painted using a two-component epoxy resin paint in a slow enamelling process.

In addition to the visual benefits, the painted blind rivet also has added protection against corrosion. Aluminium blind rivets are best suited for this procedure. In the longterm they achieve the desired visual effect when joining coloured parts.

GESIPA® blind rivets are available in the standard RAL colours. On request, steel blind rivets are also available in RAL colours or even special colours. Another method for colouring blind rivets and for protecting them against corrosion is to anodize them.

GESIPA® blind rivets are anodized in a direct current sulphuric acid process. The term Eloxal is used to describe the electrolytic oxidation of aluminium. Eloxal itself is actually colourless. Applying a second coat using metal salts creates the desired light-fast colour. The Eloxal method is more complex but is the most durable process for coloured blind rivets.

The range of coloured blind rivets includes 15 RAL colours in ten different dimensions each. The blind rivets are produced in a wet varnish drum process. The colours are similar to the RAL colours.



38

The information on shear and tensile strength, rivet pin diameters and the maximum setting head diameters can be found on **page 38**.

# COLOURED BLIND RIVETS Polygrip® in Alu/Stainless









Aluminium alloy







x = No longer in stock



stainless steel A2

D mm	D x L mm	 mm	RAL 1015 Light ivory No.	RAL 3000 Flame red No.	RAL 5010 Gentian blue No.	RAL 7011 Iron grey No.	RAL 7016 Anthracit grey No.	
<b>3.2</b>  3.3 mm	<b>3.2 x 8</b>	0.5 - 5.0	x	x	x	x	<b>145 0448</b>	B 1000
	<b>3.2 x 9.5</b>	1.5 - 6.5	x	x	x	x	<b>145 0449</b>	B 1000
	<b>3.2 x 11</b>	3.0 - 8.0	x	x	x	x	<b>144 6510</b>	B 1000
<b>4</b>   4.1 mm	<b>4 x 10</b>	0.5 - 6.5	<b>145 6036</b>	<b>145 6049</b>	<b>145 6057</b>	<b>145 6066</b>	<b>145 6159</b>	B 500
	<b>4 x 13</b>	3.5 - 9.5	<b>145 6037</b>	<b>145 6050</b>	<b>144 6496</b>	<b>145 6067</b>	<b>144 6511</b>	B 500
	<b>4 x 17</b>	7.0 - 13.0	x	x	x	x	<b>145 6160</b>	B 500
<b>4.8</b>   4.9 mm	<b>4.8 x 10</b>	0.5 - 6.5	<b>145 6039</b>	<b>145 6051</b>	<b>145 6059</b>	<b>145 6068</b>	<b>145 0450</b>	B 500
	<b>4.8 x 15</b>	4.5 - 11.0	<b>145 6040</b>	<b>145 6052</b>	<b>145 6060</b>	<b>145 6069</b>	<b>145 6161</b>	B 500
	<b>4.8 x 17</b>	6.5 - 13.0	<b>144 6487</b>	<b>145 6053</b>	<b>145 6061</b>	<b>145 0447</b>	<b>145 6162</b>	B 500
	<b>4.8 x 25</b>	11.0 - 19.5	<b>145 6041</b>	<b>145 6054</b>	<b>145 6062</b>	<b>145 6070</b>	<b>144 6512</b>	B 250

D mm	D x L mm	 mm	RAL 7022 Umbra grey No.	RAL 7024 Graphite grey No.	RAL 8014 Sepia brown No.	RAL 9002 Grey white No.	RAL 9003 Signal white No.	
<b>3.2</b>  3.3 mm	<b>3.2 x 8</b>	0.5 - 5.0	x	x	<b>145 6088</b>	<b>145 6096</b>	<b>145 6106</b>	B 1000
	<b>3.2 x 9.5</b>	1.5 - 6.5	x	x	<b>145 6089</b>	x	<b>144 6503</b>	B 1000
	<b>3.2 x 11</b>	3.0 - 8.0	x	x	<b>144 6501</b>	x	<b>145 6107</b>	B 1000
<b>4</b>   4.1 mm	<b>4 x 10</b>	0.5 - 6.5	<b>145 6074</b>	<b>145 6082</b>	<b>145 6090</b>	<b>145 6099</b>	<b>145 6108</b>	B 500
	<b>4 x 13</b>	3.5 - 9.5	<b>145 6075</b>	<b>145 6083</b>	<b>145 6091</b>	<b>145 6100</b>	<b>145 6109</b>	B 500
	<b>4 x 17</b>	7.0 - 13.0	x	x	<b>145 6092</b>	<b>145 6101</b>	<b>145 6110</b>	B 500
<b>4.8</b>   4.9 mm	<b>4.8 x 10</b>	0.5 - 6.5	x	<b>145 6085</b>	<b>145 6093</b>	<b>145 6102</b>	<b>145 6111</b>	B 500

D mm	D x L mm	 mm	RAL 9005 Jet black No.	RAL 9006 White aluminium No.	RAL 9007 Grey aluminium No.	RAL 9010 Pure white No.	RAL 9011 Graphite black No.	
<b>3.2</b>  3.3 mm	<b>3.2 x 8</b>	0.5 - 5.0	<b>145 6114</b>	x	<b>145 6131</b>	<b>145 6140</b>	<b>145 6150</b>	B 1000
	<b>3.2 x 9.5</b>	1.5 - 6.5	<b>145 6115</b>	x	<b>145 6132</b>	<b>145 6141</b>	<b>145 6151</b>	B 1000
	<b>3.2 x 11</b>	3.0 - 8.0	<b>145 6116</b>	<b>144 6505</b>	<b>145 6133</b>	<b>145 6142</b>	<b>145 6152</b>	B 1000
<b>4</b>   4.1 mm	<b>4 x 10</b>	0.5 - 6.5	<b>145 6117</b>	<b>145 6126</b>	<b>145 6134</b>	<b>145 6143</b>	<b>145 6153</b>	B 500
	<b>4 x 13</b>	3.5 - 9.5	<b>145 6118</b>	<b>144 6506</b>	<b>145 6135</b>	<b>145 6144</b>	<b>145 6154</b>	B 500
	<b>4 x 17</b>	7.0 - 13.0	<b>145 6119</b>	<b>145 6127</b>	<b>144 6508</b>	<b>145 6145</b>	<b>145 6155</b>	B 500
<b>4.8</b>   4.9 mm	<b>4.8 x 10</b>	0.5 - 6.5	<b>145 6120</b>	<b>145 6128</b>	<b>145 6136</b>	<b>145 6146</b>	<b>145 6156</b>	B 500
	<b>4.8 x 15</b>	4.5 - 11.0	<b>145 6121</b>	<b>145 6129</b>	<b>145 6137</b>	<b>145 6147</b>	<b>145 6157</b>	B 500
	<b>4.8 x 17</b>	6.5 - 13.0	<b>145 6122</b>	<b>145 6130</b>	<b>145 6138</b>	<b>145 6148</b>	<b>144 6509</b>	B 500
	<b>4.8 x 25</b>	11.0 - 19.5	<b>145 6123</b>	x	<b>145 6139</b>	<b>145 6149</b>	x	B 250

The material surcharge will be added at a daily rate.

CE: ETA certification 13/0255 Corresponding approval documents on [www.gesipa.com](http://www.gesipa.com)

All sizes on request – also available in bulk packs



# SOLARGRIP® – THE SPECIAL RIVET

**SolarGrip® – the special rivet for flexible use in solar panel installation**



IBC SOLAR AG, one of the world's leading global photovoltaic systems integrators, is investing in its cooperation with GESIPA®. GESIPA® has developed a blind rivet for the efficient IBC TopFix 200 assembly system that adequately meets the technical requirements, and has produced it in Germany.

**THE ADVANTAGES ARE CLEAR:** Fast and precise work, as well as tightness against splashing water at the riveting points, result in a durable and safe connection. We recommend using PowerBird® Solar or AccuBird® for quick and easy assembly. IBC Solar and GESIPA®, good connections are unbeatable.

## **WHAT OUR CLIENT IBC SOLAR SAYS ABOUT SOLARGRIP®:**

„By offering our IBC TopFix 200 assembly system, we provide our customers with an assembly system for pitched roofs that is approved by the building inspectorate and ensures the highest level of flexibility and quality. IBC TopFix 200 is universally usable on any pitched roof and provides solutions for many different Types of roofs. Specially-designed prefabricated module clamps are used for assembly on trapezoidal sheet metal roofs, which helps to save up to 20% of installation time compared to conventional assembly systems.

GESIPA® SolarGrip® rivets ensure quick, easy and safe assembly on the metal sheet. The rivet customised to our system and quality requirements guarantees water tightness, a long service life and the highest economic efficiency, and has proved itself in practice millions of times.

Many of our trade partners use **SolarGrip®** for convenient assembly of the substructure. The same also goes for the Haude family in Upper Franconia, Germany (see image). In 2015, the Haude family built their house in accordance with the latest energy efficiency principles, with the aim of avoiding primary energy from fossil fuels altogether. At the heart of the energy concept is a 9.7 kWp PV roof system. "To fix the assembly system to the trapezoidal sheet roof, we used pre-assembled clamps with SolarGrip® rivets – an impressive solution from our partner GESIPA®."



# SOLARGRIP® – THE SPECIAL RIVET

Millions of connections exposed to storms, rain, snow and sunlight on a daily basis are testament to the reliability of GESIPA® SolarGrip® blind rivets

**Speak to us, we will be happy to advise you!**



## SolarGrip® – The solar fastener





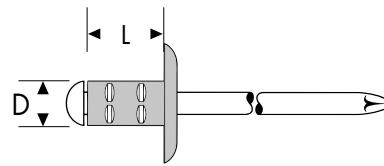

- ETA-Approval applied for ETA-13/0255
- Matching grip range for many solar applications
- Ideal for working on trapezoid panel roofs
- SolarSeal coating for 4.8 mm rivets
- Riveting of sponge rubber or EPDM washers possible
- Function documentation available on request at extra cost

## SolarGrip® – The basic characteristics

- Large grip range coverage with a single blind rivet
- Wide closing head
- Outstanding hole filling capability
- Compact closing head
- For use with all GESIPA® setting tools



## SOLARGRIP® PROGRAM

D	D x L mm	MATERIAL	 mm	N	 mm	 mm	No.	
<b>4.8 - K 11.4</b>  5.1 - 5.2 mm	4.8 x 12.0	Rivet body: Alu AlMg 2.5 (Colour: black) Mandrel: Stainless steel A2 – Nr. 1.4541	3.0 - 5.0	2,300	1,500	143 3905	P 500	
	4.8 x 15.0	Rivet body: Alu AlMg 2.5 (blank) Mandrel: Stainless steel, zinc-plated	5.0 - 8.0	2,300	1,500	143 3906	"	
<b>6.4 - K 11.4</b>  6.5 - 6.9 mm	6.4 x 14.0	Rivet body: Alu AlMg 2.5 (blank) Mandrel: Steel, zinc-plated	3.0 - 8.0	4,000	2,800	145 5678	P 250	

Material surcharge will be added at a daily rate

**CE:** ETA certification 13/0255 Corresponding approval documents on [www.gesipa.com](http://www.gesipa.com)  
All sizes on request – also available in bulk packs

# CAP® – CLOSED END BLIND RIVETS

**GESIPA® CAP® – naturally air and watertight**



1

## THE STRUCTURE



For technical reasons, the rivet mandrel of the GESIPA® CAP® blind rivet must be fixed in the rivet body. However this means that the rivet body can only deform slightly during the setting process. As a result, the cap blind rivet only has marginal hole filling capability. However this is necessary to be able to compensate large borehole tolerances.

## TIGHT CONNECTIONS WITH CARE





The above-mentioned technical situations make careful preparation of the application imperative. The hole diameter should be as tight as possible to ensure a flawless function in the application for a long period.

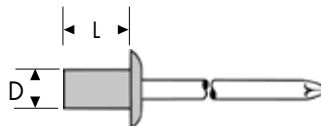

If the GESIPA® CAP® blind rivet is processed carefully, it forms the basis for a reliably „tight“ connection.

## Alu/steel Standard

-  Aluminium alloy
-  Steel, phosphate coated





D	D x L mm	 mm	No.	
<b>3.2</b>  3.3 mm	<b>3.2 x 6.5</b>	0.5 - 2.0	<b>143 3423</b>	A 500
	<b>3.2 x 8.0</b>	2.0 - 3.5	<b>143 3424</b>	"
	<b>3.2 x 9.5</b>	3.5 - 5.0	<b>143 3425</b>	"
	<b>3.2 x 10.5</b>	5.0 - 6.5	<b>145 3876</b>	"
	<b>3.2 x 12.5</b>	6.5 - 8.0	<b>145 3877</b>	"
<b>4</b>  4.1 mm	<b>4 x 8.0</b>	0.5 - 3.5	<b>143 3431</b>	B 500
	<b>4 x 9.5</b>	3.5 - 5.0	<b>143 3432</b>	"
	<b>4 x 11.0</b>	5.0 - 6.5	<b>143 3433</b>	"
	<b>4 x 12.5</b>	6.5 - 8.0	<b>143 3434</b>	"
	<b>4 x 15.0</b>	8.0 - 11.0	<b>145 3878</b>	"





D	D x L mm	 mm	No.	
<b>4.8</b>  4.9 mm	<b>4.8 x 8.0</b>	1.0 - 3.5	<b>143 3426</b>	B 500
	<b>4.8 x 9.5</b>	3.5 - 5.0	<b>143 3427</b>	"
	<b>4.8 x 11.0</b>	5.0 - 6.5	<b>143 3428</b>	"
	<b>4.8 x 12.5</b>	6.5 - 8.0	<b>143 3429</b>	"
	<b>4.8 x 14.0</b>	8.0 - 9.5	<b>143 3430</b>	"
	<b>4.8 x 16.0</b>	9.5 - 11.0	<b>145 3879</b>	"
	<b>4.8 x 18.0</b>	11.0 - 13.0	<b>143 3435</b>	"
	<b>4.8 x 21.0</b>	13.0 - 16.0	<b>143 3436</b>	B 250

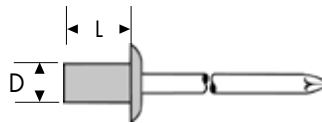

# CAP® Closed end blind rivets

## Alu/stainless steel Standard

 Aluminium alloy  
 Stainless steel





D	D x L mm	 mm	No.	
<b>3.2</b>  3.3 mm	<b>3.2 x 6.5</b>	0.5 - 2.0	<b>143 3437</b>	A 500
	<b>3.2 x 8.0</b>	2.0 - 3.5	<b>143 3438</b>	"
	<b>3.2 x 9.5</b>	3.5 - 5.0	<b>143 3439</b>	"
	<b>3.2 x 10.5</b>	5.0 - 6.5	<b>143 3440</b>	"
	<b>3.2 x 12.5</b>	6.5 - 8.0	<b>145 3890</b>	"
<b>4</b>  4.1 mm	<b>4 x 8.0</b>	0.5 - 3.5	<b>143 3441</b>	B 500
	<b>4 x 9.5</b>	3.5 - 5.0	<b>145 3891</b>	"
	<b>4 x 11.0</b>	5.0 - 6.5	<b>145 3892</b>	"
	<b>4 x 12.5</b>	6.5 - 8.0	<b>143 3442</b>	"





D	D x L mm	 mm	No.	
<b>4.8</b>  4.9 mm	<b>4.8 x 8.0</b>	1.0 - 3.5	<b>143 3443</b>	B 500
	<b>4.8 x 9.5</b>	3.5 - 5.0	<b>143 3444</b>	"
	<b>4.8 x 11.0</b>	5.0 - 6.5	<b>143 3445</b>	"
	<b>4.8 x 12.5</b>	6.5 - 8.0	<b>143 3446</b>	"
	<b>4.8 x 14.0</b>	8.0 - 9.5	<b>143 3447</b>	"
	<b>4.8 x 16.0</b>	9.5 - 11.0	<b>143 3448</b>	"
	<b>4.8 x 18.0</b>	11.0 - 13.0	<b>143 3449</b>	"
	<b>4.8 x 21.0</b>	13.0 - 16.0	<b>143 3450</b>	B 250



Material surcharge will be added at a daily rate  
 All sizes on request – also available in bulk packs

## A2 stainless steel Standard

 Stainless Steel A2 — no. 1.4301  
 Stainless Steel A1



D	D x L mm	 mm	No.	
<b>3.2</b>  3.3 mm	<b>3.2 x 6.0</b>	0.8 - 2.0	<b>145 3899</b>	A 500
	<b>3.2 x 8.0</b>	2.0 - 4.0	<b>143 3452</b>	"
	<b>3.2 x 10.0</b>	4.0 - 6.0	<b>145 3900</b>	"
	<b>3.2 x 12.0</b>	6.0 - 8.0	<b>143 3453</b>	"
<b>4</b>  4.1 mm	<b>4 x 6.0</b>	0.8 - 1.5	<b>145 3901</b>	A 500
	<b>4 x 8.0</b>	1.5 - 3.5	<b>143 3454</b>	"
	<b>4 x 10.0</b>	3.5 - 5.5	<b>145 3902</b>	B 500
	<b>4 x 12.0</b>	5.5 - 7.5	<b>143 3455</b>	"
	<b>4 x 16.0</b>	7.5 - 11.5	<b>145 3903</b>	"

D	D x L mm	 mm	No.	
<b>4.8</b>  4.9 mm	<b>4.8 x 8.0</b>	0.8 - 3.0	<b>143 3456</b>	B 500
	<b>4.8 x 10.0</b>	3.0 - 5.0	<b>143 3457</b>	"
	<b>4.8 x 12.0</b>	5.0 - 7.0	<b>143 3458</b>	"
	<b>4.8 x 16.0</b>	7.0 - 11.0	<b>143 3459</b>	"
	<b>4.8 x 20.0</b>	11.0 - 15.0	<b>143 3460</b>	B 250

Material surcharge will be added at a daily rate  
 You have to expect limited jaw life.





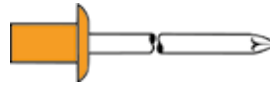
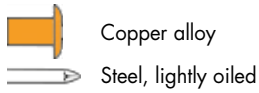

The information on shear and tensile strength, rivet pin diameters and the maximum setting head diameters can be found on **page 45**

# CAP<sup>®</sup> Closed end blind rivets





## Copper/steel Standard



D	D x L mm	 mm	No.	
<b>3.2</b>  3.3 mm	<b>3.2 x 6.0</b>	0.5 - 1.5	<b>145 3904</b>	A 500
	<b>3.2 x 7.5</b>	1.5 - 3.0	<b>145 3905</b>	"
	<b>3.2 x 9.0</b>	3.0 - 4.5	<b>145 3906</b>	"
<b>4</b>  4.1 mm	<b>4 x 9.5</b>	1.0 - 4.5	<b>145 3908</b>	A 500



## Copper/stainless Standard



D	D x L mm	 mm	No.	
<b>3.2</b>  3.3 mm	<b>3.2 x 6.0</b>	0.5 - 1.5	<b>145 3913</b>	A 500
	<b>3.2 x 7.5</b>	1.5 - 3.0	<b>145 3914</b>	"
	<b>3.2 x 9.0</b>	3.0 - 4.5	<b>145 3915</b>	"
<b>4</b>  4.1 mm	<b>4 x 9.5</b>	1.5 - 4.5	<b>145 0152</b>	B 500
	<b>4 x 11</b>	4.5 - 6.0	<b>145 0153</b>	"
	<b>4 x 12.5</b>	6.0 - 7.5	<b>145 0154</b>	"
	<b>4 x 15</b>	7.5 - 10.5	<b>145 0155</b>	"

Material surcharge will be added at a daily rate

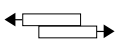
## SHEAR AND TENSILE STRENGTH CAP<sup>®</sup>-BLIND RIVETS

D mm	N 	N 	d <sub>m</sub> mm	max. d <sub>k</sub> Standard mm
<b>CAP<sup>®</sup> ALU/STEEL AND ALU/STAINLESS STEEL</b>				
<b>3.2</b>	<b>1,100</b>	<b>1,250</b>	1.7	6.5
<b>4.0</b>	<b>1,600</b>	<b>2,200</b>	2.18	8.5
<b>4.8</b>	<b>2,230</b>	<b>3,100</b>	2.63	10.0
<b>CAP<sup>®</sup>-A2 STAINLESS STEEL</b>				
<b>3.2</b>	<b>2,000</b>	<b>2,200</b>	1.9	6.5
<b>4.0</b>	<b>3,120</b>	<b>3,560</b>	2.3	8.5
<b>4.8</b>	<b>4,000</b>	<b>4,400</b>	2.9	10.0
<b>CAP<sup>®</sup>-COPPER/STEEL AND COPPER/STAINLESS STEEL</b>				
<b>3.2</b>	<b>980</b>	<b>1,340</b>	1.7	6.0
<b>4.0</b>	<b>1,350</b>	<b>2,000</b>	2.18	8.5

Test procedure according to DIN EN ISO 14589

# SPECIAL BLIND RIVETS

## Special blind rivets for dedicated tasks



There are numerous applications that require the use of special blind rivets. For this reason GESIPA® has come up with some variations to meet these requirements.

**Grooved blind rivets are suitable for riveting pocket holes** in soft materials. They are used in the furniture industry, for interior construction, in the wood and plastics processing industry, in car body construction and lots more. Important: Before processing grooved blind rivets, the borehole diameter must be determined in trials and the minimum borehole depth must be observed.

**Peel blind rivets** are required if soft or porous parts such as wood, hard-fibre, fibreglass or plasterboards need to be joined together. In the setting process, the rivet mandrel falls out of the rivet body, and on the closing head side the rivet mandrel splits the rivet shaft into four parts. These then grip into the material. Typical application fields are the assembly of plastic and wooden elements, caravan constructions and the attachment of interior panels.



The blind rivet connection itself is a permanent connection. However to attach further detachable parts, GESIPA® has the **threaded blind rivet** in its range. The threaded blind rivet has a stud bolt with an M5 or M6 outer thread to which other parts can be attached using an additional nut. The GESIPA® blind rivet stud range is listed on page 198 for parts that need greater clamping forces.

The **GESIPA®-clamp profile blind rivet** are excellently suited to comply with defined clearances when mounting parts or to set stoppers in rails. Accordingly, this special rivet is also used in the white goods and furniture industry.



**Plastic rivets** are free from corrosion, do not conduct electricity and do not damage varnished surfaces. They can be processed quickly and easily using GESIPA® manual blind rivet tools and automated riveting tools. The plastic blind rivets can be found in many trade sectors and their versatility makes them an interesting choice for a wide range of application possibilities.

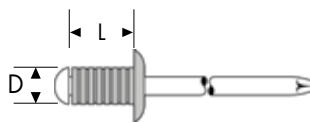

# SPECIAL BLIND RIVETS

## Grooved alu/steel Standard (Dome head)



-  Aluminium alloy
-  Steel, zinc-plated







D	D x L mm	max. thickness of material to be fixed mm	No.	
<b>3.2</b>  3.4 mm	<b>3.2 x 10</b>	6	<b>145 4100</b>	A 500
	<b>3.2 x 16</b>	12	<b>145 4101</b>	"
<b>4</b>  4.3 mm	<b>4 x 8</b>	4	<b>145 4103</b>	A 500
	<b>4 x 12</b>	8	<b>145 4104</b>	B 500
	<b>4 x 16</b>	12	<b>145 4105</b>	"

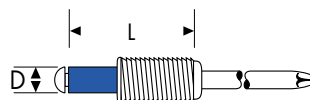

D	D x L mm	max. thickness of material to be fixed mm	No.	
<b>4.8</b>  5.1 mm	<b>4.8 x 10</b>	6	<b>145 4108</b>	B 500
	<b>4.8 x 14</b>	10	<b>145 4110</b>	B 250
	<b>4.8 x 18</b>	13	<b>145 4102</b>	"

## Threaded steel/steel



-  Steel, zinc-plated
-  Steel, zinc-plated







Thread  3.1 mm G x l mm	D x L mm	 mm	No.	
<b>M 5 x 10</b>	<b>3 x 6</b>	0.5 - 3.0	<b>145 5326</b>	A 250
<b>M 5 x 15</b>	<b>3 x 9</b>	3.0 - 6.0	<b>145 5327</b>	"

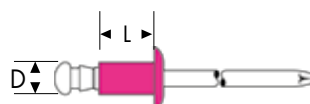

Thread  4.1 mm G x l mm	D x L mm	 mm	No.	
<b>M 6 x 10</b>	<b>4 x 5</b>	1.0 - 2.0	<b>145 5328</b>	A 250
<b>M 6 x 15</b>	<b>4 x 8</b>	2.0 - 5.0	<b>145 5329</b>	"

## Plastic Standard (Dome head)



-  Polyamid, PA 6.6
-  Polyamid, PA 6.6



D	D x L mm	 mm	No.	
<b>4</b>  4.1 mm	<b>4 x 8</b>	0.5 - 5.0	<b>145 5337</b>	B 500
	<b>4 x 12</b>	5.0 - 9.0	<b>145 5338</b>	"
<b>5</b>  5.1 mm	<b>5 x 8</b>	0.5 - 5.0	<b>145 5339</b>	B 500
	<b>5 x 12</b>	5.0 - 9.0	<b>145 5340</b>	"

D	D x L mm	 mm	No.	
<b>6</b>  6.1 mm	<b>6 x 8</b>	0.5 - 5.0	<b>145 5341</b>	B 250
	<b>6 x 12</b>	5.0 - 9.0	<b>145 5342</b>	"

## CHART SHEAR AND TENSILE STRENGTH

D mm	N		N		d <sub>m</sub> mm
<b>Grooved alu/steel</b>					
<b>3.2</b>	<b>720</b>		<b>950</b>		1.95
<b>4</b>	<b>1,400</b>		<b>2,000</b>		2.1
<b>4.8</b>	<b>1,800</b>		<b>2,700</b>		2.7

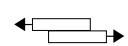
D mm	N		d <sub>m</sub> mm
<b>Threaded steel/steel</b>			
<b>3</b>	<b>1,100</b>		1.95
<b>4</b>	<b>2,000</b>		2.5

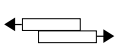
D mm	N		d <sub>m</sub> mm
<b>Plastic</b>			
<b>4</b>	<b>180</b>		2.5
<b>5</b>	<b>300</b>		3.0
<b>6</b>	<b>440</b>		3.5





Test procedure according to DIN EN ISO 14589



# SPECIAL BLIND RIVETS

## Peel alu/steel Standard

Rivet body: Aluminium alloy  
Mandrel: Steel, zinc-plated



D	D x L mm	 mm	No.	
<b>3.2</b>  3.6 mm	<b>3.2 x 10</b>	2.5 - 5.0	<b>145 5496</b>	A 500
	<b>3.2 x 12</b>	4.5 - 7.0	<b>143 3748</b>	"
	<b>3.2 x 16</b>	6.5 - 11.0	<b>145 5497</b>	"
<b>4</b>  4.4 mm	<b>4 x 8</b>	1.0 - 3.0	<b>145 5490</b>	A 500
	<b>4 x 10</b>	2.5 - 5.0	<b>145 5494</b>	B 500
	<b>4 x 12</b>	4.5 - 6.5	<b>145 5491</b>	"
	<b>4 x 14</b>	6.0 - 8.0	<b>145 5492</b>	"
	<b>4 x 16</b>	7.5 - 10.0	<b>143 3740</b>	"
	<b>4 x 18</b>	9.0 - 12.0	<b>143 3741</b>	"
	<b>4 x 20</b>	11.5 - 14.0	<b>145 5493</b>	"

D	D x L mm	 mm	No.	
<b>4.8</b>  5.2 mm	<b>4.8 x 10</b>	2.5 - 5.0	<b>143 3747</b>	B 500
	<b>4.8 x 12</b>	4.5 - 7.0	<b>143 3742</b>	"
	<b>4.8 x 14</b>	6.5 - 9.0	<b>143 3743</b>	B 250
	<b>4.8 x 16</b>	8.5 - 10.0	<b>143 3744</b>	"
	<b>4.8 x 18</b>	9.5 - 12.0	<b>143 3746</b>	"
	<b>4.8 x 20</b>	11.5 - 14.0	<b>143 3745</b>	"
	<b>4.8 x 25</b>	13.5 - 19.0	<b>143 3749</b>	"

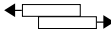

### SHEAR STRENGTH

D mm	N 	d <sub>m</sub> mm	max. d <sub>k</sub> mm
<b>3.2</b>	<b>700</b>	1.95	6.5
<b>4</b>	<b>1,200</b>	2.1	8.0
<b>4.8</b>	<b>1,700</b>	2.7	9.5

Test procedure according to DIN EN ISO 14589

## Profile clinching rivets alu/steel

Rivet body: Aluminium alloy  
Mandrel: Steel, zinc-plated

Profile Typ  3.1 mm	D x L mm	 mm	No.	
<b>HA</b>	<b>3 x 5</b>	1.0 - 2.5	<b>145 3916</b>	A 500
<b>HB</b>	<b>3 x 5</b>	1.0 - 2.5	<b>145 3918</b>	A 500
<b>HB</b>	<b>3 x 7</b>	2.5 - 4.5	<b>145 3919</b>	"
<b>W</b>	<b>3 x 5</b>	1.0 - 2.5	<b>145 3920</b>	A 500
<b>A</b>	<b>4 x 7</b>	1.0 - 4.0	<b>145 3921</b>	B 500
<b>BR</b>	<b>4 x 7</b>	1.0 - 4.0	<b>145 3922</b>	"
<b>C</b>	<b>4 x 7</b>	1.0 - 4.0	<b>145 3923</b>	"

### SHEAR STRENGTH

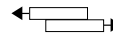
D mm	N 	d <sub>m</sub> mm
<b>3</b>	<b>450</b>	1.8
<b>4</b>	<b>850</b>	2.1

Test procedure according to DIN EN ISO 14589



TYP HA



TYP HB



TYP W



TYP A



TYP BR



TYP C



TYP KF



# G-BULB BLIND RIVETS

**G-Bulb – high strength blind rivets – in carbon steel and stainless steel**



## G-BULB BLIND RIVET

GESIPA® has developed a new range of high strength structural blind rivets called G-Bulb with diameters of 4.8 and 6.4 mm in steel and A2 stainless steel, to fit grip ranges from 1.5 up to 15.5 mm.

The G-Bulb rivet features a wide grip range, together with high shear and tensile strengths generated by the rivet function, the formation of a large closing head and the mechanical lock of the rest mandrel in the rivet body.

In combination with the patented function crimping on the rivet body, the G-Bulb provides tight and sealed joints in a large variation of hole sizes.

The G-Bulb rivet generates a large closing head which transfers high strain and clamping load to the application. With a mandrel breakload of max. 16 kN, the G-Bulb rivets can be installed with standard tooling.



# G-BULB – HIGH STRENGTH BLIND RIVETS

## THE SETTING PROCESS



### MAIN FEATURES

- Excellent hole filling capability
- High clamping force
- Excellent tensile strength through large closing head
- Excellent shear strength through mandrel locking
- Processing with standard setting tools
- Process control compatible with the TAURUS® C
- RoHS compliant

### MATERIALS





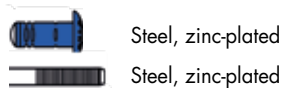

Rivet body: Steel, zinc plated CrVI-free, or stainless steel  
 A2 no. 1.4567, Mandrel: Steel, zinc plated CrVI-free, or stainless steel A2 no. 1.4541

Other surface treatments on request



## Steel/steel Dome head



D	D x L mm	 mm	No.	
<b>4.8</b>   5.0 - 5.2 mm	<b>4.8 x 10</b>	1.5 - 3.5	<b>143 3925</b>	B 500
	<b>4.8 x 13</b>	3.5 - 6.0	<b>143 3926</b>	"
	<b>4.8 x 15</b>	6.0 - 8.0	<b>143 3927</b>	"
<b>6.4</b>   6.7 - 6.9 mm	<b>6.4 x 13</b>	2.0 - 4.5	<b>143 3928</b>	B 250
	<b>6.4 x 17</b>	4.5 - 7.0	<b>143 3929</b>	"
	<b>6.4 x 20</b>	7.0 - 10.5	<b>143 3930</b>	B 200
	<b>6.4 x 23</b>	10.5 - 13.0	<b>143 3931</b>	B 150
	<b>6.4 x 25</b>	13.0 - 15.5	<b>143 3932</b>	"

Further dimensions and surface treatments on request

**CE:** ETA certification 13/0255 Corresponding approval documents on [www.gesipa.com](http://www.gesipa.com)  
 All sizes on request – also available in bulk packs

# G-BULB high strength blind rivets







## A2 stainless steel Standard Dome head

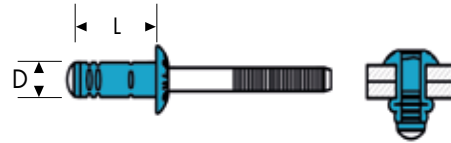

Stainless steel A2 — no. 1.4567

Stainless steel A2





D	D x L mm	 mm	No.	
<b>4.8</b>   5.0 - 5.2 mm	<b>4.8 x 10</b>	1.5 - 3.5	<b>145 6426</b>	B 500
	<b>4.8 x 13</b>	3.5 - 5.5	<b>145 6427</b>	"
	<b>4.8 x 15</b>	5.5 - 7.5	<b>143 3936</b>	"
<b>6.4</b>   6.7 - 6.9 mm	<b>6.4 x 13</b>	2.0 - 4.0	<b>143 3937</b>	B 250
	<b>6.4 x 15</b>	4.0 - 6.0	<b>143 3938</b>	"
	<b>6.4 x 17</b>	6.0 - 8.0	<b>143 3939</b>	"
	<b>6.4 x 20</b>	8.0 - 10.5	<b>143 3940</b>	B 200
	<b>6.4 x 23</b>	10.5 - 12.5	<b>143 3941</b>	B 150
	<b>6.4 x 25</b>	12.5 - 14.5	<b>143 3942</b>	B 150

Material surcharge will be added at a daily rate

Further dimensions and surface treatments on request

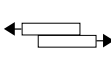
## SHEAR AND TENSILE STRENGTH G-BULB

D mm	N 	N 	d <sub>m</sub> mm	max. d <sub>k</sub> mm
<b>STEEL/STEEL</b>				
<b>4.8 x 10</b>	<b>3,600</b>	<b>3,500</b>	3.2	9.5
<b>4.8 x 13</b>	<b>4,000</b>	<b>3,500</b>	3.2	9.5
<b>4.8 x 15</b>	<b>5,600</b>	<b>3,500</b>	3.2	9.5
<b>6.4 x 13</b>	<b>8,500</b>	<b>8,000</b>	4.25	13.0
<b>6.4 x 17</b>	<b>10,000</b>	<b>8,000</b>	4.25	13.0
<b>6.4 x 20</b>	<b>11,000</b>	<b>8,000</b>	4.25	13.0
<b>6.4 x 23</b>	<b>11,000</b>	<b>8,000</b>	4.25	13.0
<b>6.4 x 25</b>	<b>11,000</b>	<b>8,000</b>	4.25	13.0
<b>A2 STAINLESS STEEL</b>				
<b>4.8 x 10</b>	<b>4,400</b>	<b>5,400</b>	3.2	9.5
<b>4.8 x 13</b>	<b>4,550</b>	<b>5,400</b>	3.2	9.5
<b>4.8 x 15</b>	<b>4,700</b>	<b>5,400</b>	3.2	9.5
<b>6.4 x 13</b>	<b>8,000</b>	<b>8,800</b>	4.25	13.0
<b>6.4 x 15</b>	<b>10,000</b>	<b>8,800</b>	4.25	13.0
<b>6.4 x 17</b>	<b>10,000</b>	<b>8,800</b>	4.25	13.0
<b>6.4 x 20</b>	<b>11,000</b>	<b>8,800</b>	4.25	13.0
<b>6.4 x 23</b>	<b>11,000</b>	<b>8,800</b>	4.25	13.0
<b>6.4 x 25</b>	<b>11,000</b>	<b>8,800</b>	4.25	13.0

Test procedure according to DIN EN ISO 14589

# POLYBULB® BLIND RIVETS

Large disc-shaped bulb formation – perfect for sensitive applications with both soft and brittle materials.



## DISC-SHAPED CLOSING HEAD

This practical closing head shape evenly distributes the contact pressure over the component, making it the perfect joining element for riveting both soft and brittle components such as plastics and composite materials. The PolyBulb® blind rivet leaves an aesthetic setting appearance.



## LARGE GRIP RANGE

A PolyBulb® blind rivet replaces up to 3 conventional blind rivets, thus reducing parts diversity. Combining several dimensions saves handling and storage costs while additionally reducing the risk of mix-up at the workplace and subsequent quality problems.

## CONTROLLED HOLE FILLING

With hole filling capabilities adapted to requirements, the PolyBulb® blind rivet provided an optimum joint.

## ADVANTAGES

- Large grip range
- Disc-shaped closing head with large closing head  $\varnothing$
- Aesthetic setting appearance, only one distinct closing head
- High tensile strength and detachment force (especially with plastic joining material)
- Controlled hole filling
- Excellent grip properties
- Locked mandrel
- Non-rattling
- Process control capabilities



# POLYBULB® BLIND RIVETS

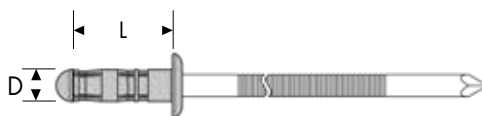



## Alu/steel Dome head



Aluminium alloy

Steel, zinc-plated

D	D x L mm	 mm	No.	
<b>4.8</b>  4.9 mm - 5.1 mm	<b>4.8 x 11</b>	1.5 - 6.0 *	<b>145 0473</b>	B 250
	<b>4.8 x 16</b>	6.0 - 10.0 *	<b>145 0474</b>	B 250



\*Reference value that changes depending on the hole diameter and the material to be riveted.

## Alu/stainless steel Dome head

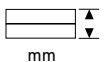

Aluminium alloy

A2 stainless steel

D	D x L mm	 mm	No.	
<b>4.8</b>  4.9 mm - 5.1 mm	<b>4.8 x 11</b>	1.5 - 4.5 *	<b>161 9573</b>	B 250
	<b>4.8 x 16</b>	6.0 - 9.0 *	<b>161 9574</b>	B 250



\*Reference value that changes depending on the hole diameter and the material to be riveted.

## Steel/steel Dome head



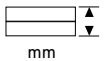

Steel, zinc-plated

Steel, zinc-plated

D	D x L mm	 mm	No.	
<b>4.8</b>  4.9 mm - 5.2 mm	<b>4.8 x 11</b>	1.5 - 6.0 *	<b>146 4926</b>	B 250
	<b>4.8 x 16</b>	6.0 - 10.0 *	<b>146 4925</b>	B 250

\*Reference value that changes depending on the hole diameter and the material to be riveted.

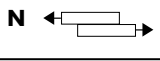
## SHEAR AND TENSILE STRENGTH

D mm	 N	 N	d <sub>m</sub> mm	max. d <sub>k</sub> mm
<b>ALU/STEEL</b>				
<b>4.8 x 11</b>	<b>1,200</b>	<b>1,900</b>	3.0	10.0
<b>4.8 x 16</b>				
<b>ALU/STAINLESS STEEL</b>				
<b>4.8 x 11</b>	<b>1,200</b>	<b>1,900</b>	3.0	10.0
<b>4.8 x 16</b>				
<b>STEEL/STEEL</b>				
<b>4.8 x 11</b>	<b>2,700</b>	<b>3,800</b>	3.0	10.0
<b>4.8 x 16</b>		<b>3,300</b>		

# MEGA GRIP® BLIND RIVETS

**GESIPA®-MEGA GRIP® –  
High strength blind rivets  
with large grip range and  
optimal cost effectiveness**



## **MEGA GRIP® BLIND RIVETS – PERFECT EFFICIENCY**

The GESIPA® MEGA GRIP® is a high strength structure blind rivet with a very large grip range. The variable grip range allows efficient use and, owing to the merging of up to five blind rivet lengths into one MEGA GRIP® dimension, reduces the handling costs.

## **THE SETTING PROCESS**

During the setting process, the hollow mandrel head presses the rivet body with great force against the rivet hole. The radial deformation here ensures that an aboveaverage, large clamping area is covered. The stable position of the rivet mandrel throughout the entire setting process guarantees compliance with the high shear force through double locking. The excellent hole filling capability also protect ideally against splash-water.

## **STANDARD OR SPECIAL PRODUCTION?**

The GESIPA® MEGA GRIP® is available in a flat Round head or recessed head form and comes in the material combinations alu/alu or steel/steel as standard. Supplied in large or small packages, the MEGA GRIP® is always available in the quantity required. We can supply special dimensions on request.

## **THE ADVANTAGES**

- Perfectly splash proof
- Efficient use with large grip range coverage
- High shear strength due to double rest mandrel locking
- Outstanding hole filling capability
- Flush removal on the setting head without sharp edges.



Please note that to achieve the best possible values from the GESIPA®-MEGA GRIP®, use of special tools/nosepieces is required.

MEGA GRIP® blind rivets are available in small packs, too! Marked with the abbreviation KV.



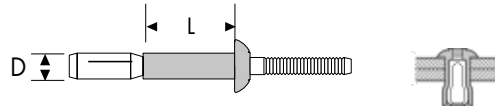

# MEGA GRIP® BLIND RIVETS

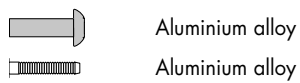

## Alu/alu

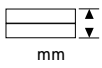
Dome head





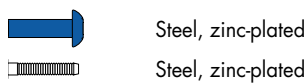

D	D x L mm	 mm	TYP	No. GV		No. KV	
<b>4.8</b>  4.9 - 5.2 mm	<b>4.8 x 10.0</b>	1.6 - 6.4	RV6900-6-4	<b>143 3805</b>	2,000	<b>143 3808</b>	B 500
	<b>4.8 x 14.0</b>	1.6 - 11.1	RV6900-6-7	<b>145 5654</b>	3,000	<b>143 3809</b>	B 250
<b>6.4</b>  6.6 - 6.9 mm	<b>6.4 x 14.1</b>	2.0 - 9.5	RV6900-8-6	<b>143 3806</b>	1,000	<b>143 3810</b>	B 200
	<b>6.4 x 19.1</b>	2.0 - 15.9	RV6900-8-10XG	<b>143 3807</b>	1,500	<b>143 3811</b>	B 100

## Steel/steel

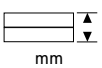
Dome head







D	D x L mm	 mm	TYP	No. GV		No. KV	
<b>4.8</b>  4.9 - 5.2 mm	<b>4.8 x 10.0</b>	1.6 - 6.4	RV6977-6-4	<b>143 3812</b>	3,000	<b>143 3816</b>	B 500
	<b>4.8 x 14.0</b>	1.6 - 11.1	RV6977-6-7	<b>145 5657</b>	3,000	<b>143 3817</b>	B 250
<b>6.4</b>  6.6 - 6.9 mm	<b>6.4 x 14.1</b>	2.0 - 9.5	RV6977-8-6	<b>143 3813</b>	1,500	<b>145 5663</b>	B 200
	<b>6.4 x 19.1</b>	2.0 - 15.9	RV6977-8-10XG	<b>143 3814</b>	1,500	<b>143 3818</b>	B 100

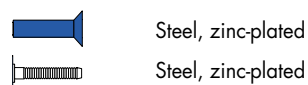

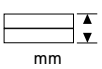
## Steel/steel

Countersunk



D	D x L mm	 mm	TYP	No. GV		No. KV	
<b>4.8</b>  4.9 - 5.2 mm	<b>4.8 x 10.0</b>	2.6 - 6.4	RV6177-6-5	<b>145 5658</b>	2,500	<b>145 5660</b>	B 250
	<b>6.4</b>	<b>6.4 x 15.8</b>	3.0 - 11.1	RV6177-8-7	<b>143 3815</b>	2,000	<b>145 5662</b>

## SHEAR AND TENSILE STRENGTH MEGA GRIP®

D mm	N		N		d <sub>m</sub> mm	max. d <sub>k</sub> mm
<b>ALU/ALU</b>						
<b>4.8</b>	<b>3,280</b>		<b>2,350</b>		2.95	9.5
<b>6.4</b>	<b>5,730</b>		<b>3,840</b>		3.9	12.7
<b>STEEL/STEEL</b>						
<b>4.8</b>	<b>6,850</b>		<b>4,500</b>		2.95	9.5
<b>6.4</b>	<b>12,455</b>		<b>8,200</b>		3.9	12.7

Test procedure according to DIN EN ISO 14589

# BULB-TITE® BLIND RIVETS

**Strong in demanding applications requiring perfect clamp force and weatherproofness**



Originally designed for the construction industry, the GESIPA®-BULB-TITE® rivets have proven their worth in many other application fields thanks to their multi-functional properties. The majority of the BULB-TITE® program has been approved by the „Deutsches Institut für Bautechnik“ in Berlin thereby guaranteeing extra security when used in steel constructions or on facades.

## **POWERFUL WHEREVER USED**

Thanks to the shear zone overlap of the BULB-TITE® rivet mandrel in the application, permanent and very high shear forces can be achieved.

## **WEATHER RESISTANCE**

The use of a special nosepiece when processing the BULB-TITE®-rivet locks the mandrel into the sealing part on the setting head side to prevent dirt and/or damp penetrating the application. The sealing washer, which is available as an optional accessory, offers added protection against wet and damp below the closing head.

## **EXCELLENT CLAMPING FORCE**

The three large pressure plates distribute the clamping forces evenly across a large area of the surface so that even soft, thin, supple or brittle materials can be riveted safely without destroying or damaging the surface.

## **COMPLEX APPLICATIONS**

BULB-TITE® rivets also guarantee a safe function where other rivets have already given up. The three plates of the closing head adapt and form to fit even curved application surfaces so that safe riveting is possible even on pipes, beads and other unusually formed applications.

## **APPLICATION AREAS**

Facades, shipbuilding, containers, truck and passenger busses production, trailers, trapezoidal sheet metal roof

## **THE ADVANTAGES**

- Large grip range
- Vibration-proof
- Use on straight and curved application parts
- Waterproof with neoprene sealing washer
- Large distribution of the grip force over a large surface

Please note that to achieve the best possible values from the GESIPA®-BULB-TITE®, use of special tools/nosepieces is required.

BULB-TITE® blind rivets are available in small packs, too! Marked with the abbreviation KV.



# BULB-TITE® BLIND RIVETS



## Alu/alu Dome head



D	D x L mm	 mm	TYP	No. KV	
<b>5.2</b>  5.3 - 5.5 mm	<b>5.2 x 19.1</b>	1.6 - 6.4	RV 6604-6-4	<b>145 5606</b>	"
	<b>5.2 x 22.2</b>	4.7 - 9.5	RV 6604-6-6	<b>145 5607*</b>	"
with EPDM washer	<b>5.2 x 17.5</b>	0.5 - 4.8	RV 6604-6-3 W	<b>145 5620</b>	B 250
	<b>5.2 x 19.1</b>	1.6 - 6.4	RV 6604-6-4 W	<b>145 5621</b>	"
	<b>5.2 x 22.2</b>	4.7 - 9.5	RV 6604-6-6 W	<b>145 5622</b>	"
	<b>5.2 x 25.4</b>	7.9 - 12.7	RV 6604-6-8 W	<b>145 5623</b>	"
<b>7.7</b>  7.8 - 8.2 mm	<b>7.7 x 27.7</b>	1.0 - 9.5	RV 6603-9-6 W	<b>145 5632</b>	"

\*Clearance –  
only while stocks last!

## Alu/alu Large flange



D	D x L mm	 mm	TYP	No. KV	
<b>7.7 - K19</b>  7.8 - 8.2 mm	<b>7.7 x 27.7</b>	1.1 - 9.5	RV 6605-9-6 W	<b>145 5633</b>	B 100
	<b>7.7 x 34.0</b>	6.4 - 15.9	RV 6605-9-10 W	<b>145 5634</b>	B 100

**CE:** ETA certification 13/0255 Corresponding approval documents on [www.gesipa.com](http://www.gesipa.com)  
All sizes on request – also available in bulk packs

## SHEAR AND TENSILE STRENGTH BULB-TITE®

D mm	N	N	d <sub>m</sub> mm	max. d <sub>k</sub> mm
<b>ALU/ALU</b>				
<b>4</b>	<b>2,000</b>	<b>1,050</b>	2.4	9.0
<b>5.2</b>	<b>2,700</b>	<b>1,950</b>	2.9	11.7
<b>7.7</b>	<b>6,650</b>	<b>4,850</b>	4.5	15.9
<b>7.7 K19</b>	<b>6,650</b>	<b>4,850</b>	4.5	19.3

# TRI-FOLD® FOLDING TYPE BLIND RIVETS

**TRI-FOLD® folding Type blind rivets – for soft and porous application materials**

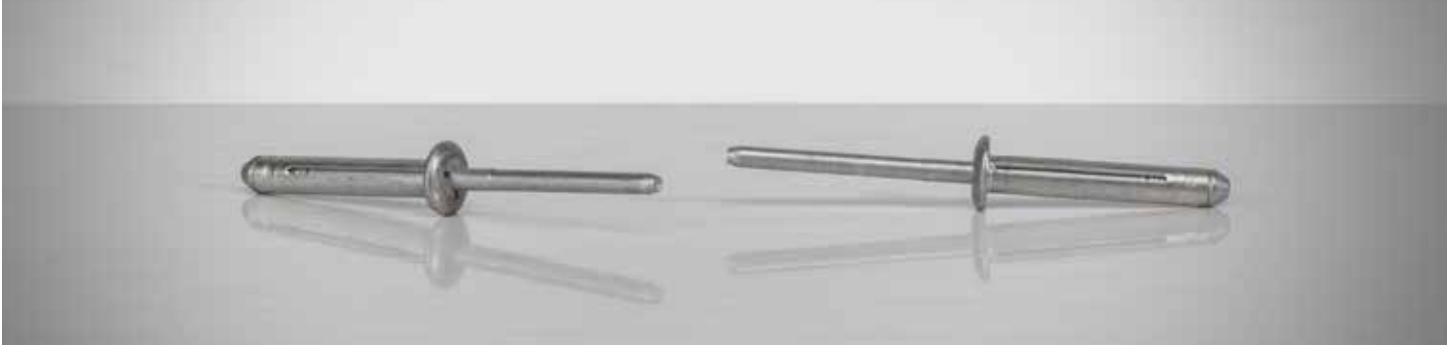

## THE FUNCTION

The GESIPA® TRI-FOLD® blind rivet forms three press lashes on the closing head side during setting.

Thanks to its special design, the TRI-FOLD® is also able to compensate over-dimensional or irregular drill hole diameters.

## THE ADVANTAGES

The large moulded lashes distribute the exerted clamping force evenly and gently onto the riveted material. Also, the large surface of the lashes offer excellent protection against the rivet being pulled through very soft, porous or brittle application parts.

## APPLICATION AREAS

TRI-FOLD® blind rivets are excellently suited for the automotive field, e.g. for plastic panelling, car body parts and for the interior work inside vehicles, but also for all other applications that are particularly soft, brittle, easily deformed or porous.

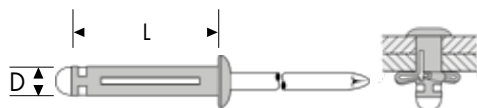

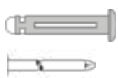

## Alu/alu

Dome head





Aluminium alloy

Aluminium alloy

D	D x L mm	 mm	TYP	No.	
<b>4.8</b>  5.1 mm	<b>4.8 x 16.0</b>	1.0 - 3.0	GAMD64ATF	<b>143 3821</b>	B 250
	<b>4.8 x 20.0</b>	3.0 - 8.50	GAMD66ATF	<b>145 5668</b>	B 250
	<b>4.8 x 25.4</b>	7.9 - 12.7	GAMD68ATF	<b>145 5669</b>	B 250

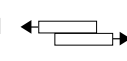
## SHEAR AND TENSILE STRENGTH

D mm	N 	N 	d <sub>m</sub> mm	max. d <sub>k</sub> mm
<b>TRI-FOLD® Alu/Alu</b>				
<b>4.8</b>	<b>1,100</b>	<b>1,400</b>	2.9	10.1

Test procedure according to DIN EN ISO 14589

## **CORDLESS BLIND RIVET SETTING TOOLS**

**Manual blind rivet setting tools –  
Easy to operate, tried and tested!**

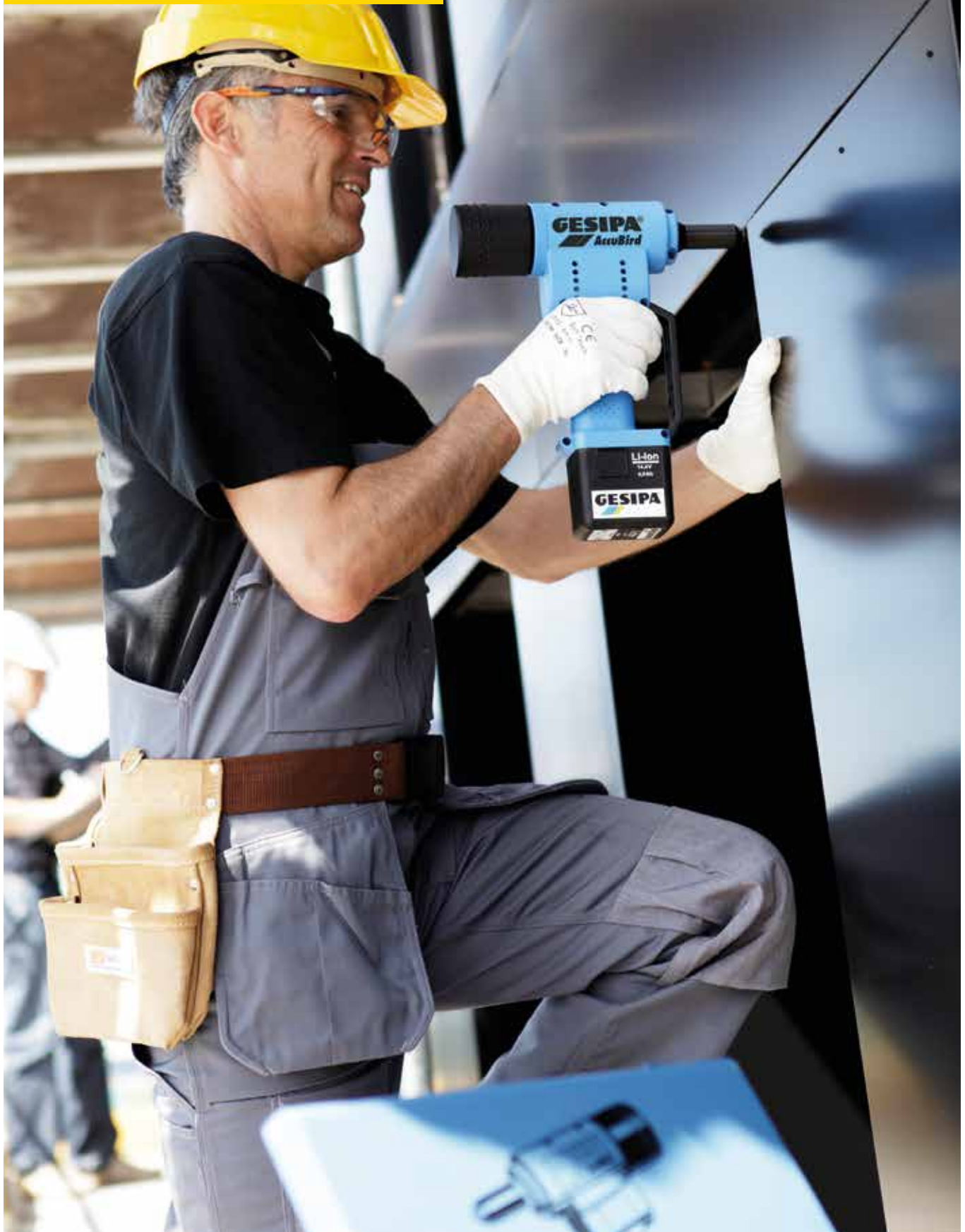

# CORDLESS BLIND RIVET SETTING TOOLS

## BLIND RIVET HAND TOOLS

62



64

NTS



65

NTX & NTX-F



66

Flipper®



68

Flipper® Plus



70

HN2



71

SN2

## BATTERY POWERED BLIND RIVET SETTING TOOLS

72

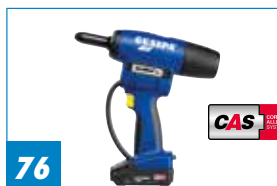

76

AccuBird® Pro



78

PowerBird® Pro



80

iBird® Pro



84

iBird® Pro C



86

Pro series with spring-loaded trigger system



90

AccuBird®

# WHAT RIVETS WHAT?

		Ø mm									
		2.4	3.0	3.2	4.0	4.8	5.0	6.0	6.4	8.0	
											
NTS, NTX, NTX-F, Flipper®, Flipper® Plus	H	●	●	●	●	A	A				
HN2, SN2	H		●	●	●	●	●	●	●		
AccuBird®	B	●	●	●	●	●	●	A			
AccuBird® Pro	B	●	●	●	●	●	●	●			
iBird® Pro, iBird® Pro C, PowerBird® Pro Gold Edition, PowerBird® Pro Gold Edition with spring-loaded trigger system	B	X	X	X	X	●	●	●	●	A	
		PolyGrip®				G-Bulb		MEGA GRIP® *	BULB-TITE® *	TRI-FOLD®	PolyBulb®
		3.2	4.0	4.8	6.4	4.8	6.4			4.8	4,8
NTS, NTX, NTX-F, Flipper®, Flipper® Plus	H	●	●	A						A	
HN2	H	●	●	●	SE with X	●	X	X	X	●	●
HN2-BT	H								●		●
SN2	H	●	●	●	●	●				●	●
AccuBird®, AccuBird® Pro	B	●	●	●		●			X¹	●	●
iBird® Pro, iBird® Pro C	B	●	●	●	●	●		6.4	X at 7.7	●	●
PowerBird® Pro Gold Edition, PowerBird® Pro Gold Edition with spring-loaded trigger system	B	●	●	●	●	●	●	6.4	X at 7.7	●	●

**H:** Handtool

**B:** Battery-powered tool

**X:** Special accessories required

**X1:** At 6.3 AS

**Y:** Accessories included in the scope of delivery effectively expand the working range.

**A:** Alu/Copper

**S:** Steel

**E:** Stainless Steel / Monel

**Blue box:** All materials (ASE) can be riveted. Where there are exceptions, the letters of the rivetable materials are provided directly in the box.

\*: A special nosepiece is **always** required when setting MEGA GRIP® blind rivets and BULB-TITE® blind rivets

# BLIND RIVET HAND TOOLS

**GESIPA® manual blind rivet setting tools – Easy to operate, tried and tested, always good but now even better!**

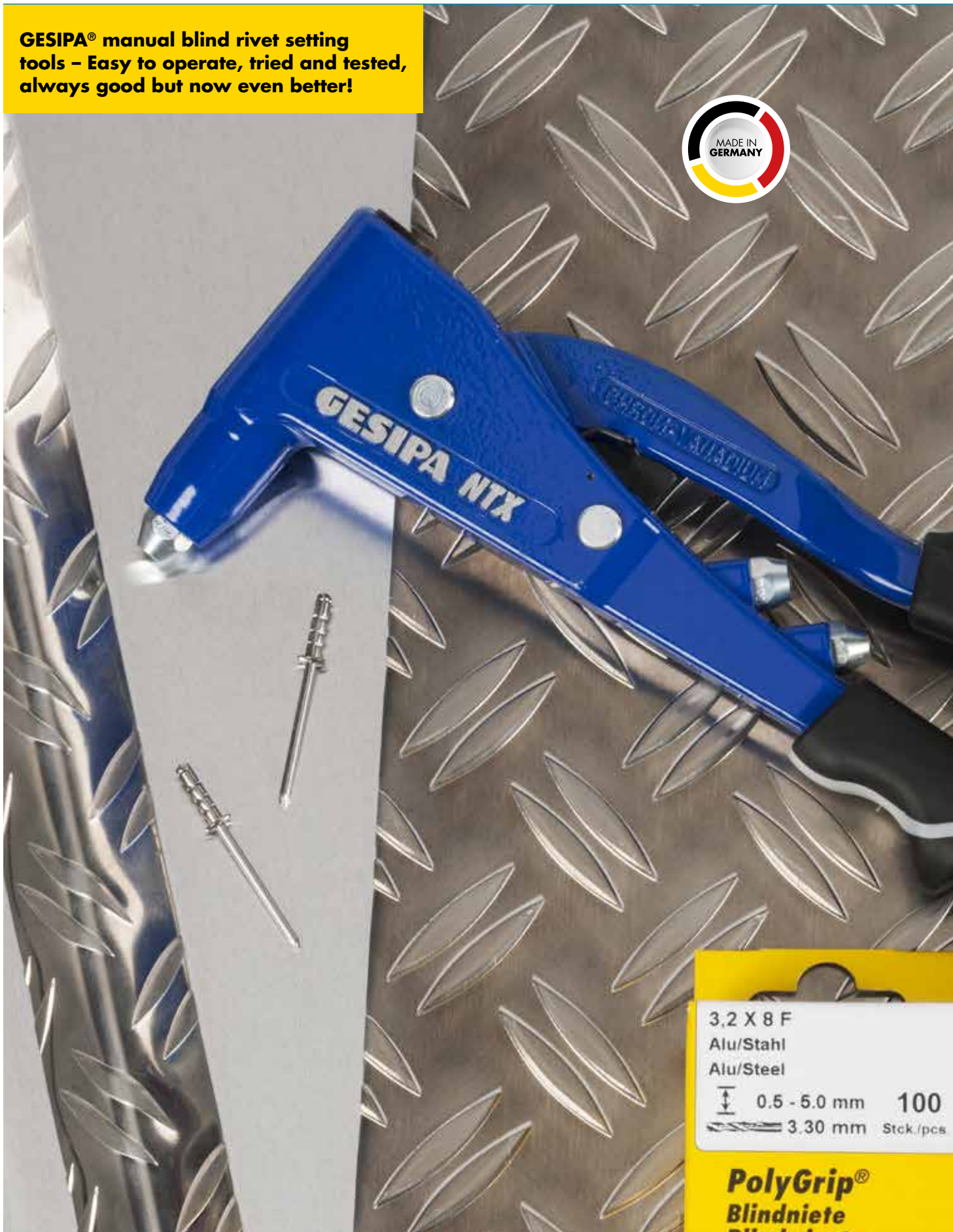

3,2 X 8 F  
Alu/Stahl  
Alu/Steel  
0.5 - 5.0 mm 100  
3.30 mm Stck./pcs

**PolyGrip®**  
**Blindniete**  
**Blind rivets**

**TRIED AND TESTED TECHNOLOGY AND QUALITY IN A NEW DESIGN**

# NTX & NTX-F

**Housing**

Improved performance thanks to newly designed housing



**Locking clip**

Optimised locking clip (NTX-F)



**Surface**

Powder-coated abrasion-resistant housing surface in GESIPA® colour

**Ergonomics**

Ergonomically formed handles for working efficiently without fatigue

**HANDLES**

- Ergonomically formed handles for working efficiently without fatigue
- Improved haptics by use of softer material
- Non-slip even in oily environments
- Environmentally compatible thanks to PVC-free handles
- Visually upgraded by GESIPA® logo and contrast stripes
- Optimised locking clip

**HOUSING**

- Improved performance thanks to newly designed housing
- Powder-coated abrasion-resistant housing surface in GESIPA® colour

**ADVANTAGES**

- Simple one-hand operation
- Effortless lever system
- Specially hardened GESIPA® jaw system
- Rugged design and durable
- Equipped with the most commonly used GESIPA® nosepieces secured directly on the tool
- Nosepieces quick and easy to change
- Worldwide service and spare parts available for decades to come
- Made in Germany



# BLIND RIVET HAND TOOLS

## NTS (with self opening spring)



**No. 143 4028**

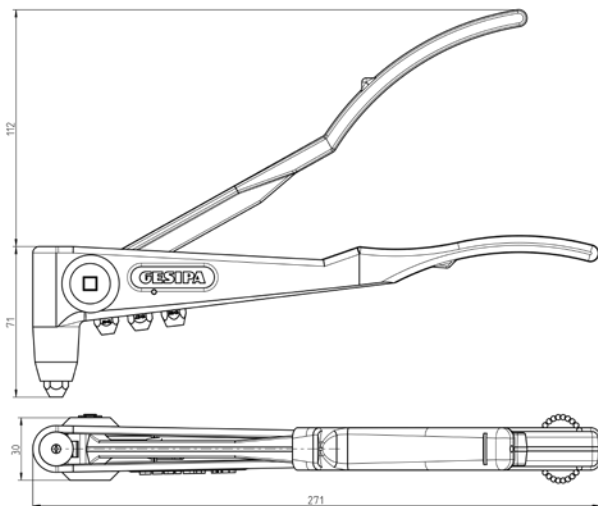

Dimensions in mm

### TECHNICAL DATA

Weight: 480 g  
Total length: 275 mm  
Stroke: 8 mm

### WORKING RANGE

Blind rivets up to 5 mm Ø aluminium  
and 4 mm Ø steel and stainless steel  
(max. mandrel Ø 3.0 mm)

### SCOPE OF DELIVERY

Nosepieces: 10/18, 10/24, 10/27 and 10/32  
1 maintenance wrench, operating instructions with  
spare parts list

### ADVANTAGES

- Body casing in high-quality die cast aluminium
- Body head made of forged steel
- Narrow head for difficult to access rivet locations
- Opening spring for automatic ejection of the mandrel
- Ergonomic handles

### JAWS (2-PARTS)

For NTS, NTX, NTX-F and Flipper®

**No. 143 4071**



Nosepiece assignment for  
NTS, NTX and NTX-F can  
be found on **page 71**.



# BLIND RIVET HAND TOOLS

## NTX



No. 143 4040

### TECHNICAL DATA

Weight: 575 g  
Total length: 260 mm  
Stroke: 8 mm

### WORKING RANGE

Blind rivets up to 5 mm Ø aluminium and 4 mm Ø steel and stainless steel (max. mandrel Ø 3.0 mm)

### SCOPE OF DELIVERY NTX

Nosepieces: 10/18, 10/24 and 10/32  
1 maintenance wrench, operating instructions with spare parts list

### SCOPE OF DELIVERY NTX-F

Nosepieces: 10/24, 10/27 and 10/32  
1 maintenance wrench, operating instructions with spare parts list

### JAWS (2-PARTS)

For NTS, NTX, NTX-F and Flipper®

No. 143 4071

## NTX-F (with self opening spring)



No. 143 4042

### ADVANTAGES

- Body casing in high-quality die cast aluminium
- Body head made of chrome-vanadium steel, forged
- Steel inserts on all bearing points subject to wear
- Intermediate lever system reduces the force required and dampens the tear-off effect
- Narrow pliers head for difficult to access rivet-locations
- Ergonomic slip handles
- Simple maintenance – fast jaw change

### FURTHER ADVANTAGES NTX-F

- With self opening spring for automatic mandrel ejection

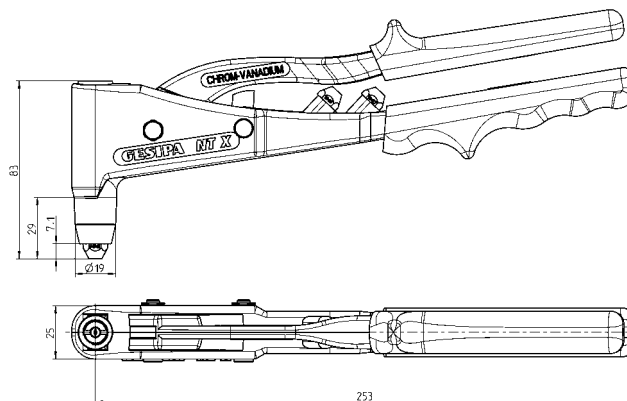

Dimensions in mm

# FLIPPER®

The blind rivet hand tool for easy handling with only one hand.

No. 143 3950

## TECHNICAL DATA

Weight:	750 g
Total length:	221 mm
Total stroke:	16.2 mm
Single action stroke:	1.8 mm

## WORKING RANGE

Blind rivets up to 5 mm Ø aluminium and 4 mm Ø steel and stainless steel (max. mandrel Ø 2.8 mm)

## SCOPE OF DELIVERY

Nosepieces: 10/18, 10/24 and 10/29  
1 maintenance wrench (on magazine)  
Operating instructions with spare parts list

## ADVANTAGES

- The force increases when the handle is closed. This is made use of via the special arrangement of the lever when setting blind rivets: ergonomic design
- The required manual force is reduced by around 40 percent if actuated several times.
- Actuation lever with an opening spring for easy single-handed operation
- Jaw mechanism with spring reset for safe and automatic mandrel ejection
- Rivet mandrel collection container can be clipped to the body casing and is easy to empty
- Larger device lift: a benefit when handling extra long blind rivets
- Sturdy body casing in high-quality die cast aluminium
- Sturdy actuation lever made of tempered steel
- Link pin on anti-twist bearings
- Ergonomic lever positions and handle design

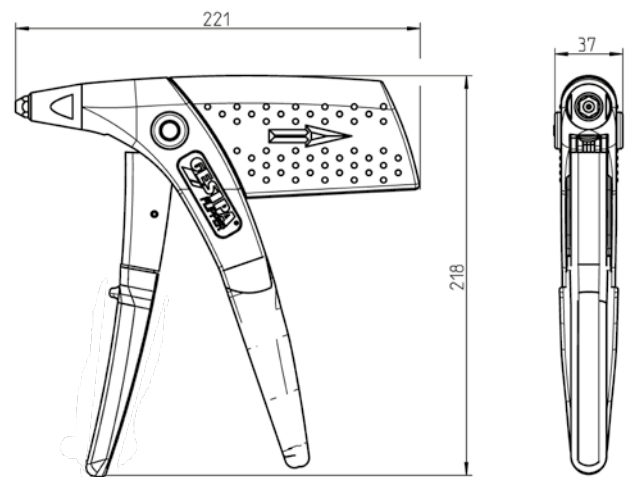

Dimensions in mm

## CONVERSION KIT FOR PLASTIC BLIND RIVETS

No. 143 3984



Nosepiece assignment for Flipper® can be found on **page 71**.

## **SORTIMENT** Blind rivet hand tools

### **RIVETING KIT**

#### **CONTENTS**

Blind rivet hand tool **NTX**  
and **12 blind rivet sizes**,  
1 maintenance wrench.  
Weight: approx. 3.75 kg  
Dimensions: 340 x 205 x 40 mm



**No. 143 5457**

#### **Incl. 12 blind rivet sizes**

Alu/steel	3.0 x 8.0 mm
Alu/steel	3.0 x 10.0 mm
Alu/steel	3.0 x 12.0 mm
Alu/steel	4.0 x 5.0 mm
Alu/steel	4.0 x 6.0 mm
Alu/steel	4.0 x 8.0 mm
Alu/steel	4.0 x 10.0 mm
Alu/steel	4.0 x 12.0 mm
Copper/steel	3.0 x 6.0 mm
Copper/steel	4.0 x 6.0 mm
Alu/steel	3.0 x 5.0 mm
Alu/steel	3.0 x 7.0 mm

### **JUNIOR RIVETING KIT**

#### **CONTENTS**

Blind rivet hand tool **NTX**  
and **5 blind rivet sizes**,  
1 maintenance wrench.  
Weight: approx. 2.5 kg  
Dimensions: 275 x 145 x 40 mm



#### **JUNIOR RIVETING KIT**

**No. 143 5459**

#### **JUNIOR RIVETING KIT POLYGRIP®**

**No. 145 7662**

#### **Incl. 5 blind rivet sizes:**

Alu/steel	3.0 x 6.0 mm
Alu/steel	3.0 x 8.0 mm
Alu/steel	4.0 x 6.0 mm
Alu/steel	4.0 x 10.0 mm
Steel/steel	3.0 x 6.0 mm



Now also available as **Junior riveting kit PolyGrip®** (Part no. 145 7662) with the sizes 3.2 x 8, 4 x 10, 4 x 17, 4.8 x 10 and 4.8 x 17.

### **FLIPPER®-BOX**

#### **CONTENTS**

Blind rivet hand tool  
**Flipper®** and **3 PolyGrip®**  
**blind rivet sizes**, in a light-  
weight plastic carrying case.  
Weight: approx. 0.9 kg  
Dimensions: 220 x 200 x 40 mm



**No. 143 3951**

#### **Incl. 3 blind rivet sizes:**

PolyGrip® Alu/steel	3.2 x 8.0 mm
PolyGrip® Alu/steel	4.0 x 10.0 mm
PolyGrip® Alu/steel	4.8 x 10.0 mm



**248**

Mini pack refills can be found on page **248**.

# FLIPPER® PLUS Combi setting tool

The combi setting tool for blind rivets and blind rivet nuts!

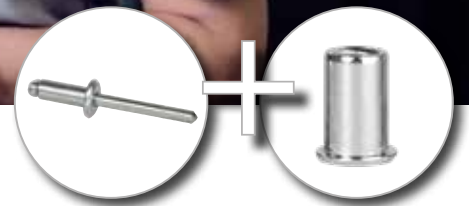

Converted in under 1 minute in just a few simple steps

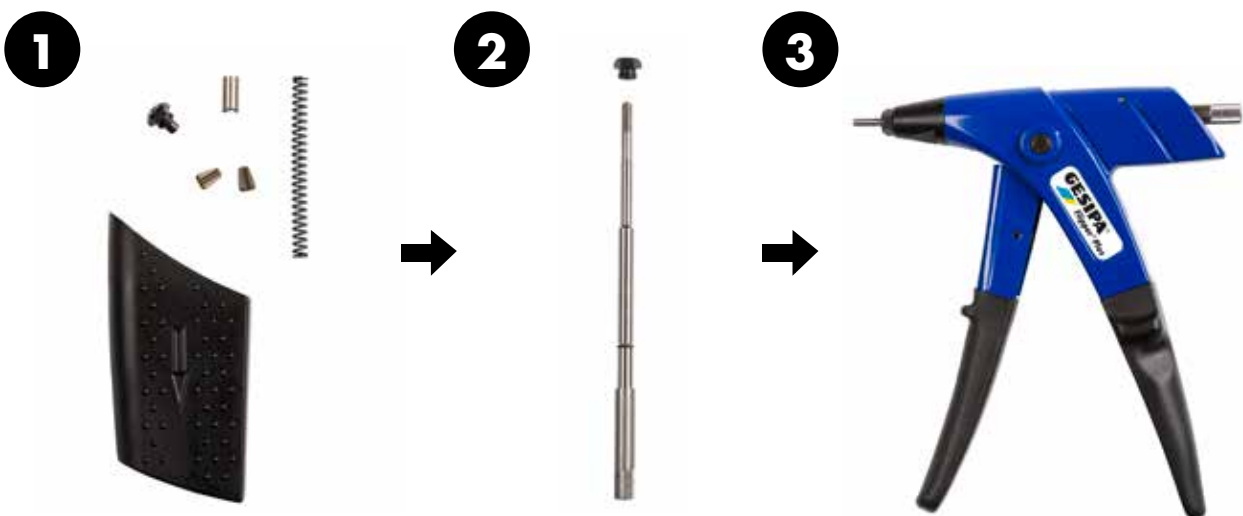

YouTube



Watch conversion on youtube!

## 1. REMOVAL

Remove the parts shown in the image

## 2. INSTALLATION

Install the threaded mandrel and nosepiece

## 3. CONVERTED

Converted to a blind rivet nut setting tool

# ONE SETTING TOOL – TWO FUNCTIONS

**Virtually tool-free conversion from blind rivet to blind rivet nut setting tool**

**No. 157 1258**

## TECHNICAL DATA

Weight:	750 g
Total length:	217 mm
Total stroke:	16.2 mm
Single action stroke:	1.8 mm

## SCOPE OF DELIVERY

Nosepieces: 12/20, 12/24, 12/29, 12/M4, 12/M5 and 12/M6  
 Threaded mandrel conversion kit: M4, M5 and M6  
 1 maintenance wrench, 1 Allen key  
 1 jaw insertion aid  
 Operating instructions with spare parts list



## WORKING RANGE BLIND RIVETS

Blind rivets up to 5 mm Ø aluminium and 4 mm Ø steel and stainless steel (max. mandrel Ø 2.7 mm)

## ADVANTAGES WHEN SETTING BLIND RIVETS

- Jaw mechanism with spring reset for safe and automatic mandrel ejection
- Rivet mandrel collection container can be clipped to the body casing and is easy to empty
- Larger device lift: a benefit when handling extra long blind rivets

## SHARED ADVANTAGES

- New ratchet function
- The force increases when the handle is closed. This finding is put to good use in a special lever arrangement for setting blind rivets and blind rivet nuts: ergonomic design
- The required manual force is reduced by around 40 percent if actuated several times.
- Actuation lever with an opening spring for easy single-handed operation

## WORKING RANGE BLIND RIVET NUTS

Blind rivet nuts from M4 up to M6 aluminium as well as from M4 up to M5 steel

## ADVANTAGES WHEN SETTING BLIND RIVET NUTS

- The total stroke is 16.2 millimeter long for setting of new generation multigrip blind rivet nuts like the GESIPA® PolyGrip® blind rivet nuts
- Simplified setting procedure for blind rivet nuts

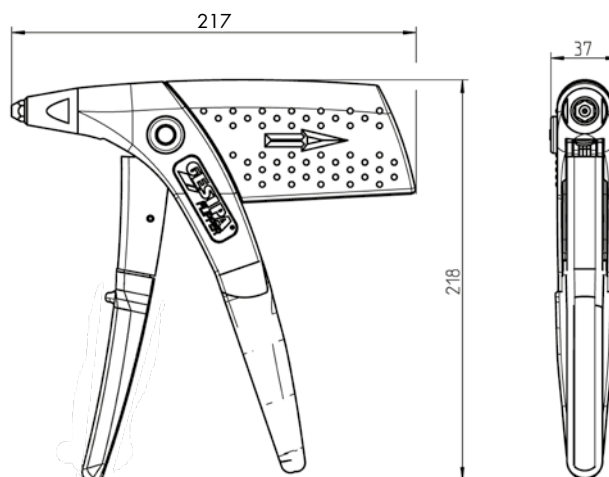

Dimensions in mm

# LEVER RIVETING TOOLS

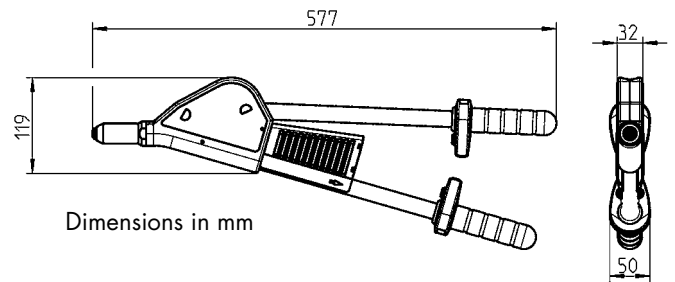

## HN2

No. 143 4107

### TECHNICAL DATA

Weight: 1.85 kg  
Total length: 570 mm  
Stroke: 10 mm

### WORKING RANGE

Blind rivets from 3.0 to 6.4 mm Ø all materials, except PolyGrip® blind rivets with 6.4 mm Ø made of stainless steel and G-Bulb blind rivets (max. mandrel Ø 4.3 mm)

### SCOPE OF DELIVERY

Nosepieces:  
16/29, 16/32, 16/36, 16/40 and 16/45  
Spent mandrel container  
Maintenance instructions with spare parts list

### JAWS (3 PARTS)

No. 143 4103

### ADVANTAGES

- Pliers casing in high-quality die cast aluminium, its sturdy design protects it against soiling
- Link pin on anti-twist bearings and with inner axial protection, wear-proof and smooth running
- Tooth segment transmission with favourable lever arm arrangement reduces the force required and dampens the tear-off effect
- Fixed casing lever and ergonomic handle design: simple and easy handling

## HN2-BT

No. 145 6714

(only for BULB-TITE® see page 56)

### TECHNICAL DATA

Weight: 1.85 kg  
Total length: 570 mm  
Stroke: 10 mm

### WORKING RANGE

Blind rivets up to 7.7 mm Ø all materials  
(max. mandrel Ø 4.5 mm)

### SCOPE OF DELIVERY

Nosepieces:  
16/26 BT, 16/32 BT, 16/42 BT and 16/48 BT  
Spent mandrel container  
Maintenance instructions with spare parts list

### JAWS (3 PARTS)

No. 143 4173

- Actuation lever: repeated re-engagement very easy, even on workpiece; highly beneficial for oversized blind rivets
- Gear rack: supported on a brass plate; smooth running
- Rivet mandrel collection tank: swivel-mounted to the casing; can be emptied easily and safely



71

Nosepieces and performance see **page 71**.

# LAZY TONG RIVETING TOOL



## SN2

No. 145 6674

### TECHNICAL DATA

Weight:	1.93 kg
Length when closed:	310 mm
Length when opened:	810 mm
Stroke:	10.5 mm

### WORKING RANGE

Blind rivets from 3.0 up to 6.4 mm Ø all materials  
G-Bulb blind rivets up to 4.8 mm Ø.  
(max. mandrel Ø 4.3 mm)

### SCOPE OF DELIVERY

Nosepieces for Ø 3.2 mm, 4.0 mm, 4.8 mm, 6.0 mm and 6.4 mm, 1 maintenance wrench, Operating instructions with spare parts list

### ADVANTAGES

- Pliers casing and handle in high-quality die cast aluminium
- Shear system in high strength steel, galvanised
- Moulded handle — double bearing
- Narrow casing for difficult to access rivets
- Enclosed pliers casing prevents soiling
- Favourable lever arm arrangement with 4-joint slide block bearing — reduced effort

### JAWS (3 PARTS)

No. 143 4958



94

Retaining nosepiece **page 94.**

### NOSEPIECE ASSIGNMENT for manual, lazy tongue and lever rivet devices

D	Rivet material	NTS, NTX, NTX-F, Flipper®	Flipper® Plus	SN2	HN2	HN2-BT
2.4	Alu	10/18	12/20	—	—	—
3.2	CAP®-Alu, CAP®-Cu	10/18	12/20	—	—	—
3 and 3.2	Alu, Cu, Steel, Stainless steel, Stinox, Alu, PG-Alu, PG-Steel	10/24	12/24	17/24	16/24	—
4	Alu, Cu	10/24	12/24	17/24	16/24	—
4	CAP®-Alu, CAP®-Cu, Alu, PG-Alu	10/27	12/24	17/27	16/27	—
4	Steel, Stainless steel, Stinox, PG-Steel	10/29	12/29	17/29	16/29	—
4.8	CAP®-Alu, CAP®-Cu	10/29	12/29	17/29	16/29	—
5 and 4.8	Alu, PG-Alu	10/32	12/32	17/29	16/29	—
5 and 4.8	Steel, Alu	—	12/32	17/32	16/32	—
5 and 4.8	Stainless steel, Stinox, PG-Steel	—	—	17/36	16/36	—
6	Alu	—	—	17/36	16/36	—
6	Steel	—	—	17/40	16/40	—
6.4	Alu, PG-Alu	—	—	17/40	16/40	—
6.4	Steel, Alu	—	—	17/45	16/45	—
4	alle <b>BULB-TITE®</b>	—	—	—	—	16/26
5.2	alle <b>BULB-TITE®</b>	—	—	—	—	16/32
6.3	alle <b>BULB-TITE®</b>	—	—	—	—	16/42
7.7	alle <b>BULB-TITE®</b>	—	—	—	—	16/48

The name of the nosepiece (e.g. 17/32) can be found directly on the nosepiece.



128

All nosepieces **page 128.**

Nosepiece assignment data apply to DIN and GESIPA® blind rivets.

# BIRD PRO SERIES

NEW

The alliance of the best –  
The manufacturer-independent  
battery system



## GESIPA® RELIES ON CAS

### The alliance of the best

More than 180 electrical devices – but just one battery! With the Cordless Alliance System (abbreviated: CAS) tools from all participating manufacturers for a wide range of applications are combined easily thanks to uniform batteries and charging devices. GESIPA® is now one of the participating manufacturers and the CAS system is being extended to include battery-powered riveting tools.

### Riveting with the CAS system

The first setting tools which can rivet with the CAS battery technology will be available in spring 2021. The complete Bird Pro series will be converted step by step, up to summer 2021.

## The benefits are close at hand

By converting the Bird Pro riveting tools to the CAS battery system, from now on the premium manufacturer of riveting technology and the leading provider of battery technology will be working together. Thanks to the large number of strong CAS partners – including special applications, there will be an important convergence of power and innovation. By using the CAS batteries in multiple different tools, the user gains flexibility and cost advantages. The system also offers the reliability of a future-proof battery technology.

Here you can find the  
additional CAS partners





The battery blind rivet setting devices with 100 % leading battery technology

### MAXIMUM POWER – FOR EVERY APPLICATION

The CAS battery packs are particularly long-lasting and powerful. Depending on the design, they are based on Li-Ion or LiHD technology. At GESIPA® the blind riveting and blind rivet nut setting tools can be purchased as standard with 2.0 Ah battery packs - the compact 4.0 Ah battery is also available as an accessory. But of course all other available CAS battery packs can also be used with our Bird Pro devices.



#### Li-ION BATTERY PACK 18V

- Ultra M technology: Intelligent battery management for long-lasting battery packs
- Patented "AIR COOLED" charging technology
- Permanent Electronic Single Cell Protection (ESCP) when charging, for particularly long life.
- Processor-controlled charge and discharge management
- Capacity display with almost no self-discharge
- Capacity display with almost no self-discharge
- One battery pack for everything. 100% compatibility with all 18 V machines and chargers of the CAS partners

#### THE OPTION: LiHD BATTERY PACK 18V

- More power with the new LiHD cell technology together with a newly developed battery pack
- High-current power rails and enlarged contacts
- 3 times better conductivity with cell connectors made of a special copper alloy
- Optimum protection against dirt with fully-sealed and protectively coated electronics, as well as optimum sealing in the lid design
- Cells protected by rubber buffers
- More usable cell energy means less frequent charging
- External rubber coating of the battery pack ensures safe and non-slip positioning and also acts as shock protection

You will find our new Bird Pro series based on the CAS-System for blind rivets on page 76, for blind rivet nuts on page 214.



# OVERVIEW Bird Pro Series

TOOL	SETTING FORCE IN N	WORKING RANGE
<p><b>ACCUBIRD® PRO</b></p> 	<p><b>13,000</b></p>	<p>Blind rivets from Ø 2.4 mm up to Ø 6 mm all materials (max. mandrel Ø 3.7 mm)</p>
<p><b>POWERBIRD® PRO GOLD EDITION</b></p> 	<p><b>20,000</b></p>	<p>Blind rivets up to Ø 6.4 mm all materials and BULB-TITE®-blind rivets up to Ø 7.7 mm all materials (max. mandrel Ø 4.3 mm)</p>
<p><b>iBIRD® PRO</b></p> 	<p><b>20,000</b></p>	<p>Blind rivets up to Ø 6.4 mm all materials and BULB-TITE®-blind rivets up to Ø 7.7 mm all materials (max. mandrel Ø 4.3 mm)</p>
<p><b>iBIRD® PRO C</b></p> 	<p><b>15,000</b></p>	<p>Blind rivets up to Ø 6.4 mm all materials (except high-strength blind rivets) and BULB-TITE®-blind rivets up to Ø 7.7 mm all materials (max. mandrel Ø 4.3 mm)</p>

## SYMBOLS FOR BATTERY AND CHARGER



CAS battery 18 V/2.0 Ah (Li-Ion) in scope of delivery

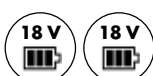

2 CAS batteries in scope of delivery







1 Charger 18 V Li-Ion in scope of delivery



Tool is delivered in the L-BOXX



Tool is delivered in a carton

DRIVE	STROKE	BATTERY LI-ION	WEIGHT	PAGE
Brushless motor (BLDC)	25 mm	 18 Volt 2.0 Ah	2.1 kg with battery	<b>76</b>
Brushless motor (BLDC)	25 mm	 18 Volt 2.0 Ah	2.1 kg with battery	<b>78</b>
Brushless motor (BLDC)	25 mm	 18 Volt 2.0 Ah	2.1 kg with battery	<b>80</b>
Brushless motor (BLDC)	25 mm	 18 Volt 2.0 Ah	2.2 kg with battery	<b>84</b>

# ACCUBIRD® PRO

Up to 4x faster than other battery-powered tools on the market!



No. 167 9659



No. 167 9660



No. 167 9661



No. 167 9662



## TECHNICAL DATA

Setting force: 13,000 N  
Weight: 2.1 kg with battery (2.0 Ah)  
Drive: brushless motor (BLDC)  
Stroke: 25 mm

## SCOPE OF DELIVERY

Nosepieces: 17/20, 17/24, 17/27, 17/29, 17/32, 17/36, 17/40, Additional jaw pusher for bigger blind-rivet dimensions (Required nosepieces page 130)

## WORKING RANGE

Blind rivets from Ø 2.4 mm up to Ø 6 mm all materials (max. mandrel Ø 3.7 mm)

## ADVANTAGES

### Brushless motor

The brushless motor and 13,000 N setting force make the AccuBird® Pro extremely fast for setting blind rivets of any material up to Ø 5 mm.

### Extremely fast, virtually no wear

The BLDC motor of the AccuBird® Pro has an extremely long service life and is virtually non-wearing. Compared to commercially available battery-powered tools, setting can be done up to 4x faster making it comparable with hydropneumatic blind rivet setting tools.

### Well-proven and ergonomically designed

The AccuBird® Pro is equipped with the low-wear jaws system and features the same ergonomic design as the TAURUS® series, already proven a thousand times over.



NOW IN THE L-BOXX!

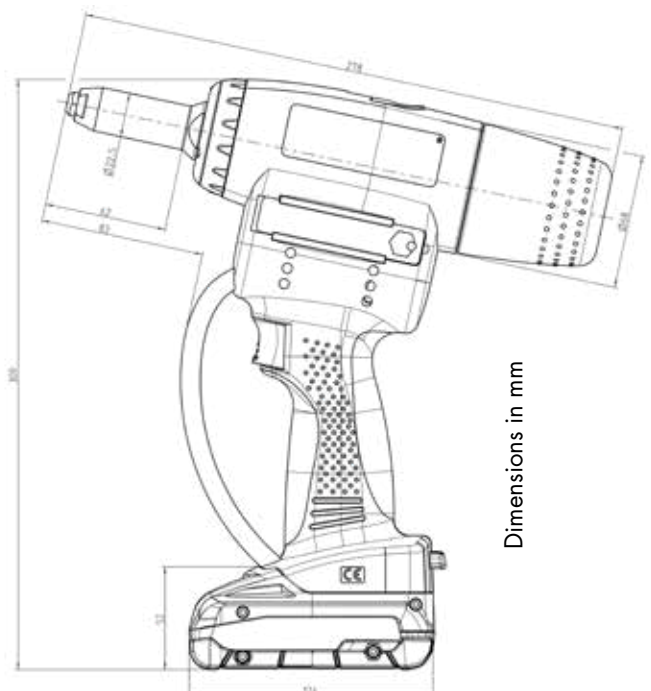

Dimensions in mm

The battery-powered blind rivet setting tool with **13 kN** setting force and brushless motor

## NOSEPIECE ASSIGNMENT Power per battery charge

D	Material	approx.pc / battery charge	Nosepiece	No.
2.4	Alu	<b>1,800</b>	17/18*	<b>143 4976</b>
3.2	CAP®-Alu, CAP®-Cu	<b>1,300</b>	17/18*	<b>143 4976</b>
3 and 3.2	Alu	<b>1,100</b>	17/24	<b>143 4955</b>
3 and 3.2	Steel	<b>1,100</b>	17/24	<b>143 4955</b>
3 and 3.2	Stainless steel	<b>1,100</b>	17/24	<b>143 4955</b>
4	Alu	<b>1,100</b>	17/24	<b>143 4955</b>
4	Steel	<b>1,000</b>	17/27	<b>143 4973</b>
4	stainless steel	<b>950</b>	17/29	<b>143 4974</b>
4.8 and 5	Alu	<b>850</b>	17/29	<b>143 4974</b>
4.8 and 5.0	Steel, Alu	<b>1,000</b>	17/32	<b>143 4975</b>
4.8 and 5.0	Stainless steel	<b>700</b>	17/36	<b>143 4977</b>
6.0	Alu	<b>650</b>	17/36	<b>143 4977</b>
6.0	Steel	<b>500</b>	17/40	<b>143 4999</b>

The name of the nosepiece (e.g. 17/32) can be found directly on the nosepiece.



## BULB-TITE® BLIND RIVETS

4	Alu	<b>1,300</b>	17/26 BT*	<b>143 4985</b>
5.2	Alu	<b>1,100</b>	17/32 BT*	<b>143 4986</b>
6.3	Alu	<b>800</b>	17/42 BT*	<b>143 4988</b>
6.3	Steel	<b>550</b>	17/42 BT*	<b>143 4988</b>

\* available as special accessory. Special design nosepieces are available on request. The nosepiece allocation data applies to DIN and GESIPA® blind rivets.

**88** Spare parts and special accessories AccuBird® Pro **page 88.**

**130** Extended nosepieces, special lengths and special nosepieces on **page 130.**

**!** Make sure the correct jaw pusher is used as specified in the operating instructions!

# POWERBIRD® PRO GOLD EDITION

**PowerBird® Pro Gold Edition – the strong one for high volumes and fast working sequences**



No. 167 9664



No. 167 9665



No. 167 9666



No. 167 9667



## TECHNICAL DATA

Setting force: 20,000 N  
Weight: 2.1 kg with battery (2.0 Ah)  
Drive: 18 V brushless DC motor (BLDC)  
Stroke: 25 mm

## SCOPE OF DELIVERY

Nosepieces: 17/32, 17/36, 17/40 and 17/45  
Additional jaw pusher for smaller blind-rivet dimensions (Required nosepieces page 130)

## WORKING RANGE

Blind rivets up to Ø 6.4 mm all materials and BULB-TITE®-blind rivets up to Ø 7.7 mm all materials (max. mandrel Ø 4.3 mm)

## ADVANTAGES

**Even more powerful:** Thanks to the brushless motor and the 20,000 N setting force the PowerBird® Pro Gold Edition is even more powerful and can even set G-Bulb and PolyGrip® blind rivets up to Ø 6.4 mm in any material. The optional Autoreverse function additionally shortens the pulling process, ensuring the PowerBird® Pro Gold Edition is immediately ready for operation. The stroke has been substantially increased to 25 mm for the purpose of setting particularly long rivets.

**Even faster, virtually no wear:** The motor of the PowerBird® Pro Gold Edition has an extremely long service life, is virtually non-wearing and and reliably guarantees the fastest setting frequencies.

**Well-proven and ergonomically designed:** Features the same ergonomic design as the TAURUS® series, already proven a thousand times over.



**NOW IN THE L-BOXX!**

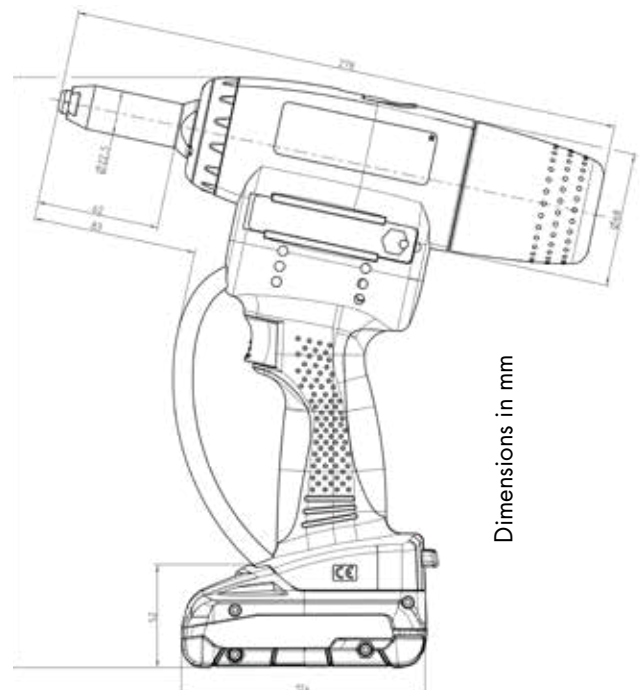

The battery-powered blind rivet setting tool with **20 kN** setting force and brushless motor

### NOSEPIECE ASSIGNMENT Power per battery charge

D	Material	approx.pc / battery charge	Nosepiece	No.
4.8 and 5.0	Steel, Alu	<b>1,800</b>	17/32	<b>143 4975</b>
4.8 and 5.0	Stainless steel	<b>1,600</b>	17/36	<b>143 4977</b>
6.0	Alu	<b>1,000</b>	17/36	<b>143 4977</b>
6.0	Steel	<b>650</b>	17/40	<b>143 4999</b>
6.0	Stainless steel	<b>600</b>	17/40	<b>143 4999</b>
6.4	Alu, PG-Alu	<b>600</b>	17/45	<b>143 4860</b>
6.4	Steel	<b>550</b>	17/45	<b>143 4860</b>
6.4	Stainless steel	<b>500</b>	17/45	<b>143 4860</b>
8	Alu	<b>550</b>	17/45	<b>143 4860</b>

The name of the nosepiece (e.g. 17/32) can be found directly on the nosepiece.



### BULB-TITE® BLIND RIVETS

4.0	Alu	<b>1,300</b>	17/26 BT*	<b>143 4985</b>
5.2	Alu	<b>1,200</b>	17/32 BT*	<b>143 4986</b>
6.3	Alu	<b>800</b>	17/42 BT*	<b>143 4988</b>
6.3	Steel	<b>550</b>	17/42 BT*	<b>143 4988</b>
6.3	Monel	<b>600</b>	17/42 BT*	<b>143 4988</b>
7.7	Alu	<b>700</b>	17/48 BT*	<b>143 4989</b>

\* available as special accessory. Special design nosepieces are available on request. The nosepiece allocation data applies to DIN and GESIPA® blind rivets.

### MEGA GRIP® BLIND RIVETS

4.8	Alu	<b>1,000</b>	17/31 MG*	<b>143 4993</b>
4.8	Steel	<b>950</b>	17/31 MG*	<b>143 4993</b>
4.8	Stainless steel	<b>900</b>	17/31 MG*	<b>143 4993</b>
6.4	Alu	<b>950</b>	17/41 MG*	<b>143 4865</b>
6.4	Steel	<b>250</b>	17/41 MG*	<b>143 4865</b>
6.4	Stainless steel	<b>250</b>	17/41 MG*	<b>143 4865</b>



**88**

Spare parts and special accessories PowerBird® Pro Gold Edition **page 88.**



**130**

Extended nosepieces, special lengths and special nosepieces on **page 130.**



Make sure the correct jaw pusher is used as specified in the operating instructions!

# iBIRD® PRO

**iBird® Pro – the optional setting process assistant from GESIPA® provides assistance when evaluating riveting processes**



**No. 167 9681**



**No. 167 9682**



**No. 167 9683**



**No. 167 9684**



## TECHNICAL DATA

Connection: WiFi 2.4/5.0 GHz and  
Bluetooth  
Setting force: 20,000 N  
Weight: 2.2 kg with battery (2.0 Ah)  
Drive: 18 V brushless DC motor (BLDC)  
Stroke: 25 mm

## SCOPE OF DELIVERY

Nosepieces: 17/32, 17/36, 17/40 and 17/45  
Additional jaw pusher for smaller blind-rivet dimensions (Required nosepieces page 130)

## WORKING RANGE

Blind rivets up to Ø 6.4 mm all materials and  
BULB-TITE®-blind rivets up to Ø 7.7 mm all materials  
(max. mandrel Ø 4.3 mm)

## INDUSTRY 4.0 WITH THE iBIRD® PRO

Known as Industry 4.0, M2M or the Internet of Things, these concepts refer to intelligent and digitally networked systems in the production industry. The aim is to ensure that production is as self-organised as possible. GESIPA® has developed the iBird® Pro with this in mind. The iBird® Pro is a networked battery-powered setting tool that can be connected to smartphones, tablets or a customer's IT infrastructure using WiFi or Bluetooth via a free GESIPA® app. This networking provides a number of additional benefits such as the monitoring of riveting processes, processing safety, status and service indicators, as well as quick and simple access to operating, maintenance and repair instructions – ultimately resulting in optimisation of the value chain.



**NOW IN THE L-BOXX!**

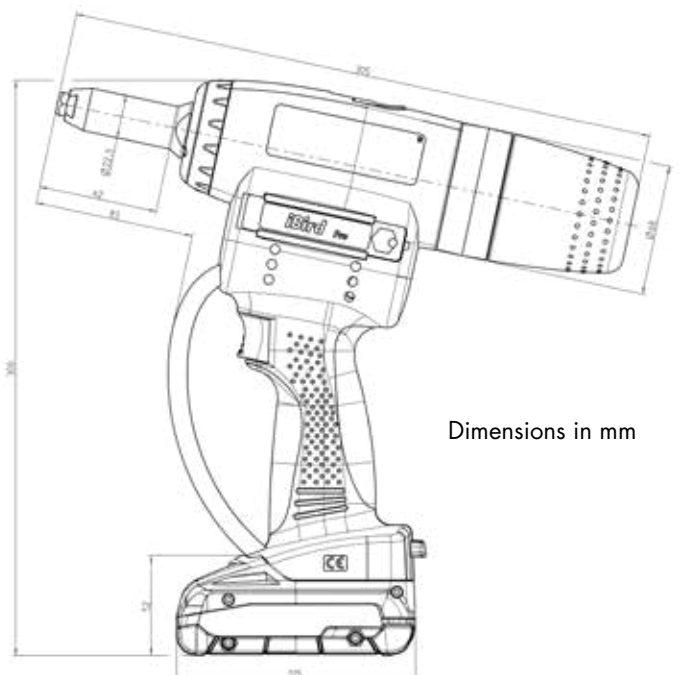

Dimensions in mm



Make sure the correct jaw pusher is used as specified in the operating instructions!



**NOSEPIECE ASSIGNMENT** Power per battery charge

D	Material	approx.pc / battery charge	Nosepiece	No.
4.8 and 5.0	Steel, Alu	<b>1,000</b>	17/32	<b>143 4975</b>
4.8 and 5.0	Stainless steel	<b>700</b>	17/36	<b>143 4977</b>
6.0	Alu	<b>650</b>	17/36	<b>143 4977</b>
6.0	Steel	<b>500</b>	17/40	<b>143 4999</b>
6.0	Stainless steel	<b>450</b>	17/40	<b>143 4999</b>
6.4	Alu, PG-Alu	<b>550</b>	17/45	<b>143 4860</b>
6.4	Steel	<b>450</b>	17/45	<b>143 4860</b>
6.4	Stainless steel	<b>400</b>	17/45	<b>143 4860</b>
8	Alu	<b>500</b>	17/45	<b>143 4860</b>

The name of the nosepiece (e.g. 17/32) can be found directly on the nosepiece.



**BULB-TITE® BLIND RIVETS\***

4.0	Alu	<b>1,200</b>	17/26 BT*	<b>143 4985</b>
5.2	Alu	<b>1,000</b>	17/32 BT*	<b>143 4986</b>
6.3	Alu	<b>800</b>	17/42 BT*	<b>143 4988</b>
6.3	Steel	<b>700</b>	17/42 BT*	<b>143 4988</b>
6.3	Monel	<b>650</b>	17/42 BT*	<b>143 4988</b>
7.7	Alu	<b>700</b>	17/48 BT*	<b>143 4989</b>

\* available as special accessory. Special design nosepieces are available on request. The nosepiece allocation data applies to DIN and GESIPA® blind rivets.

**MEGA GRIP® BLIND RIVETS\***

4.8	Alu	<b>800</b>	17/31 MG*	<b>143 4993</b>
4.8	Steel	<b>750</b>	17/31 MG*	<b>143 4993</b>
4.8	Stainless steel	<b>750</b>	17/31 MG*	<b>143 4993</b>
6.4	Alu	<b>700</b>	17/41 MG*	<b>143 4865</b>
6.4	Steel	<b>300</b>	17/41 MG*	<b>143 4865</b>
6.4	Stainless steel	<b>250</b>	17/41 MG*	<b>143 4865</b>

**88** Spare parts and special accessories iBird® Pro **page 88.**

**130** Extended nosepieces, special lengths and special nosepieces on **page 130.**

## iBird® Pro – Advantages at a glance!

### ADVANTAGES

- For smartphone, tablet, PC
- Simple connection to the tool with GESIPA® app via QR code
- Data availability at any time
- A signal ring (andon ring) for visualising riveting processes
- Optional connection to three devices at the same time
- Premium software: optional (availability of) setting process

### TECHNICAL FACTS

- WiFi 2.4/5.0 GHz and Bluetooth (LE) wireless connection
- Tilt sensor can be connected via the app; during use, the tool is only enabled for the next riveting process once the tilting motion for ejecting the mandrel body has been performed
- Andon ring: Signal ring for visualising the riveting process, the colours can be set individually via the app

### THE ANDON RING

The iBird® Pro incorporates a signal ring for visualising riveting processes. The colours can be set individually via the app.



### PREMIUM SOFTWARE

Optional setting process assistant\*

- Setting process evaluation with fault detection, notification in app and via Andon ring (signal ring lights up based on the setting process evaluation and colour setting)
- Teaching mode for teaching in rivet configurations
- Creation of job lists to process various rivet configurations

**No. 157 0451**

\*Once paid premium software has been activated



# Die GESIPA® app – simple connection and all information you need at a glance!

## THE GESIPA® APP

Using a QR code, the iBird® Pro can be connected to the GESIPA® app with ease. The app is available for smartphones, tablets and PCs (Android and iOS).

The iBird® Pro can be connected to three devices at the same time.

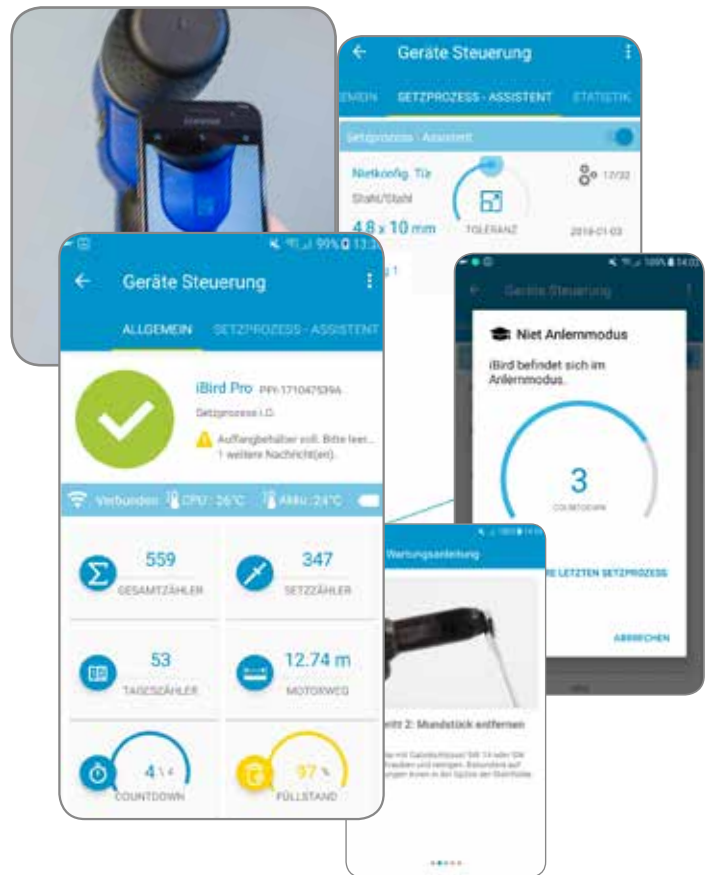

2

Simple connection of the iBird® Pro with the GESIPA® app via QR code

For smartphone, tablet, PC (Android and iOS)

Premium software: setting process assistant

Connection with three smartphones, tablets or PCs at the same time (e.g. operator, foreman, process control centre)



## WHAT THE IBIRD® PRO APP OFFERS:

- Various counters:
- Total, day, setting counter, countdown, OK\*, NOK\*.
- Fill level indicator, service indicator (spent mandrel container, cleaning or oiling jaws, full service)
- Optional setting process assistant\*
- Monitoring of battery charge level, battery temperature and temperature of the tool control
- Maintenance instructions, maintenance history
- Error message, error history, acknowledgement history
- Tips and tricks
- Operating instructions

\*Once paid premium software has been activated

# iBIRD® PRO C

The newest member of the Bird Pro Series with setting process monitoring – it safeguards processes reliably and without cords!

NEW



No. 168 0647

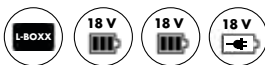

## TECHNICAL DATA

Connection: WiFi 2.4/5.0 GHz and Bluetooth  
Setting force: 15,000 N  
Weight: 2.2 kg with battery (2.0 Ah)  
Drive: 18 V brushless DC motor (BLDC)  
Stroke: 25 mm

## SCOPE OF DELIVERY

Nosepieces: 17/32, 17/36, 17/40 and 17/45

## WORKING RANGE

Blind rivets up to Ø 6.4 mm all materials (except high-strength blind rivets) and BULB-TITE®-blind rivets up to Ø 7.7 mm all materials (max. mandrel Ø 4.3 mm)

## INDUSTRY 4.0 WITH THE iBIRD® PRO C

Industry 4.0, M2M or also IoT, refers to intelligent and digitally-networked systems within the manufacturing sector. The objective is controlled and safe processes.

The iBird® Pro C connects via WiFi with the new GESIPA® Interface 4.0 which can be used for full control of the device. The data from the setting process is seamlessly integrated within the process environment of the customer, and vice versa: the customer's process environment controls the device (release, selection of profiles, etc.). Parameters can be set centrally.



Connected with the new GESIPA® Interface 4.0!



The result of the setting process is displayed both on the Andon ring as well as on the display of the device. Different colours of the Andon ring are used for example to show the status of communication or operation. The display on the iBird® Pro C also shows error messages.

Since unlike pneumatic setting devices, neither hoses or cables are in the way, the uses of the iBird® Pro C are very flexible, and it is particularly suitable for areas which are difficult to access (e.g. within body-work).

# iBird Pro® C – The blind rivet setting tool with setting process monitoring

## INTERFACE 4.0 – FOR CONNECTION TO EXTERNAL CONTROL

The process data is stored on the interface in a database for later evaluation. Using an SSD, the number of datasets is virtually unlimited. The interface also stores error messages (internal and from the iBird® Pro C).

### The new features are:

- 2 x Ethernet interfaces, router functions
- 1 x USB and 1 x USB-OTG
- Screen connection, graphic output via DVI
- Wi-Fi, as access point and as client, Wi-Fi router function
- Local OLED display to show status and error messages
- M.2 SSD interface, the module can be retrofitted with an SSD (large databases)
- PCIe connector for Hilscher netJACK modules (i.e. direct connection to industrial buses such as PROFINET, SERCOS and EtherCAT possible)



126

Special accessories  
Interface 4.0 for iBird® Pro C  
on **page 126.**



## ADVANTAGES iBIRD® PRO C

- Process reliability via setting process monitoring
- Force/displacement diagram (force measurement with DMS sensor)
- Optionally with up to 3 analysis windows (Wintech)
- Optional contact monitoring possible
- Seamless process documentation (Database)
- Status and errors available in the network for maintenance purposes
- Quality control takes place during production
- Brushless motor, therefore extremely fast and virtually wear-free
- Flexible applications

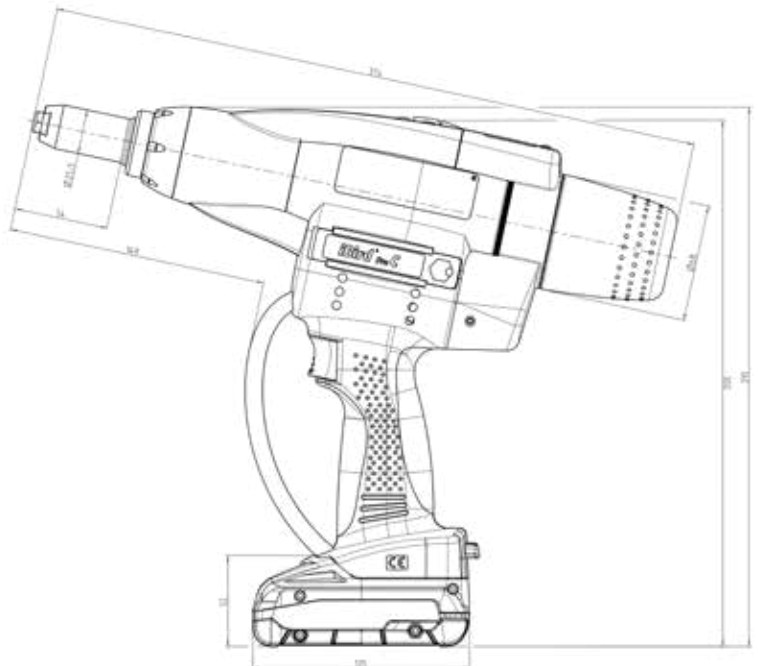

# BIRD PRO SERIES WITH SPRING-LOADED TRIGGER SYSTEM

The well-proven spring-loaded trigger system of the TAURUS® series now also for the Bird Pro series



**AccuBird® Pro** with spring-loaded trigger system

**No. 168 0294**   

**No. 168 0293** 

**PowerBird® Pro Gold Edition**  
with spring-loaded trigger system

**No. 168 0296**   

**No. 168 0295** 



Example image of PowerBird® Pro GE

The spring-loaded trigger system ensures that the parts to be riveted reliably make contact without any gaps before riveting. Furthermore, the operator will be certain that the blind rivet has reached its end position in the hole before setting and the setting head is in contact with the material. The pressing force can be varied with springs depending on the application.

## FUNCTIONAL PRINCIPLE

The surface contact trigger mechanism is also installed on the trigger button of the device. It only allows the riveting device to trigger when a set compressive force on the part is reached. This ensures that the various components in the application are pressed correctly onto each other before the riveting process. This means that uncontrolled deformation of the rivet body between the materials is prevented, which would otherwise go undetected.

The surface contact force can be varied in five steps. It is set by either adding or removing springs. This rules out the possibility of unintentionally changing the defined surface contact force. A row of pushbuttons is arranged in front of the standard trigger button. On overcoming the spring force and reaching the defined surface contact force, the riveting process can only be triggered by pressing the yellow button.

## TECHNICAL DATA

See AccuBird® Pro page 76

See PowerBird® Pro Gold Edition page 78

## DIMENSIONED DRAWING OF BIRD PRO SERIES WITH SPRING-LOADED TRIGGER SYSTEM

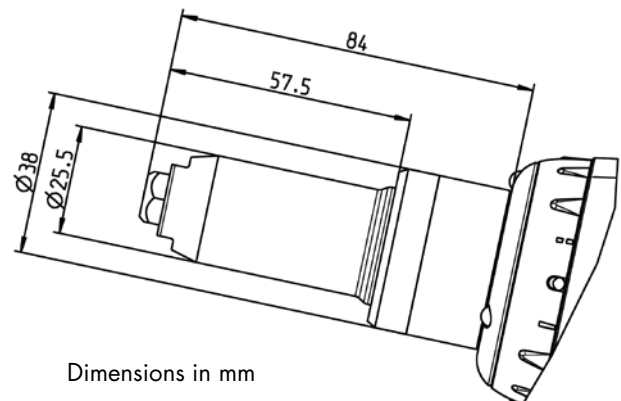

Dimensions in mm

# ANGLE HEAD 90° for the Bird Pro series

The angle head can be positioned freely in every position (360°) on the tensile axis.

No. 146 4882

## TECHNICAL DATA

Weight: 1.1 kg  
Stroke: 23 mm  
Traction power: up to 20 kN

## SCOPE OF DELIVERY

Nosepiece: 17/45 (No. 143 4860)

The angle head 90° is designed for use in very narrow and confined spaces. The rugged design makes it possible to set blind rivets with a high setting force even in working areas that are difficult to access.

The angle head 90° can set standard blind rivets with a diameter up to 6.4 mm in all materials and 8 mm in aluminium with a setting force up to 20 kN. The smallest edge distance is 15 mm, the head length 110 mm.

The 17/45 nosepiece is included in the scope of delivery as standard. Nosepieces from 17/18 to 17/40 can also be used with the angle head 90°; however, this depends on the working range of the respective tool type (AccuBird® Pro or PowerBird® Pro Gold Edition).

## ADVANTAGES

- Realisation of small edge clearances
- High setting force in tight installation areas
- Large stroke
- Simple assembly
- Compact and robust design
- Simple jaws maintenance
- Use of standard jaws

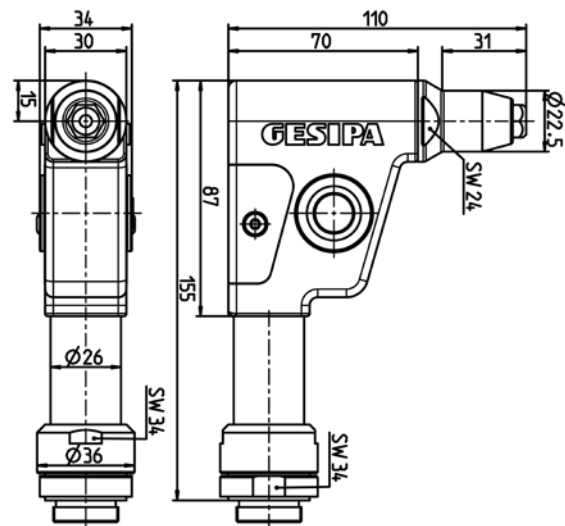

Dimensions in mm

# SPARE PARTS / SPECIAL ACCESSORIES for Bird Pro series

## 18V LI-POWER 2.0 AH BATTERY

Weight: 0.4 kg / available as special accessory



**No. 167 9689**

## 18V LiHD 4.0 AH BATTERY

Weight: 0.6 kg / available as special accessory



**No. 167 9690**

## CHARGER FOR 18.0 V LI-ION BATTERY

### Technical data

Input voltage: 220 - 240 V / 50 - 60 Hz  
 Output voltage: 12 - 36 V DC  
 Charging time: 2.0 Ah = approx. 40 minutes  
 4.0 Ah = approx. 80 minute  
 Weight: 0.6 kg



Note:  
Equipped with  
Euro plug as  
standard

EU packed

**No. 167 9694**

UK packed

**No. 167 9695**

US packed

**No. 167 9696**

## RETAINING NOSEPIECE

Special accessory (also for SN2)

- Inserted rivet stays in any position
- Set rivets with only one hand
- Safer working

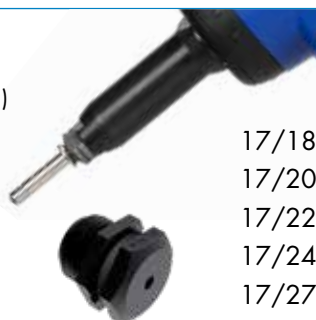

\*Except AccuBird® Pro

17/18R	<b>No. 165 5422</b>	17/29R	<b>No. 165 5429</b>
17/20R	<b>No. 165 5424</b>	17/32R	<b>No. 165 5430</b>
17/22R	<b>No. 165 5426</b>	17/36R	<b>No. 165 5431</b>
17/24R	<b>No. 165 5427</b>	17/40R*	<b>No. 165 5433</b>
17/27R	<b>No. 165 5428</b>	17/45R*	<b>No. 165 5434</b>

## JAWS (3-PART)



**No. 143 5568**

## L-BOXX

The L-BOXX can be ordered individually or including the inlay.



NEW

L-BOXX + Inlay

**No. 169 1413**

L-BOXX

**No. 162 2522**

Inlay

**No. 167 9823**

## TRANSPARENT SPENT MANDREL CONTAINER

The classic spent mandrel container allows you to keep an eye on the amount of spent mandrels.



**No. 145 0837**

## EXTENDED SPENT MANDREL CONTAINER

Option to replace standard spent mandrel container (69 mm).



Size 1: 99 mm (extended by 30 mm)

**No. 145 0838**

Size 2: 129 mm (extended by 60 mm)

**No. 145 0839**



# SPARE PARTS / SPECIAL ACCESSORIES for Bird Pro series

## EXTENSION UNITS

### ONE-PIECE

replace the steel head sleeve, they are slim and are therefore particularly suitable for tight spaces that are difficult to access



TOOL	+35 mm	+85 mm	+135 mm
AccuBird® Pro	145 0860	145 0861	145 0862
PowerBird® Pro Gold Edition	145 7650	145 7651	145 0823

TOOL	+50 mm	+100 mm	+150 mm
PowerBird® Pro Gold Edition with spring-loaded trigger system	145 0821	145 0822	-

### EXAMPLE one-piece

#### Bird Pro tools

Example: + SL 35 mm

Steel head sleeve length =  
62 mm (X) + SL 35 = 97 mm

#### PowerBird Pro GE with spring-loaded trigger system

Example: + SL 50 mm

Steel head sleeve length =  
57,5 mm (X) + SL 50 mm = 107,5 mm

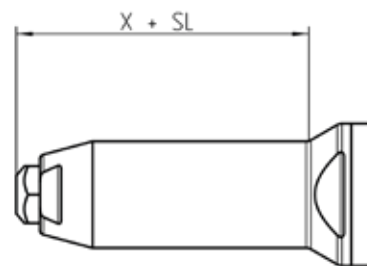

The variable X can be found in the dimension drawings of the devices.

**Dimension X** = Standard steel head sleeve length (with standard nosepiece)

### MULTI-PIECE

are suitable for riveting in low-lying places. They are screwed on between the tool and the existing steel head sleeve

Variable extension of the steel head sleeve is possible in steps of 100 mm

TOOL	+100 mm
AccuBird® Pro	145 0859
PowerBird® Pro Gold Edition	145 0820



### EXAMPLE multi-piece

#### Bird Pro tools

Example: + SL 100 mm

Steel head sleeve length =  
62 mm (X) + SL 100 mm = 162 mm

### CHANGEOVER SET FOR SMALL JAW ASSEMBLY

The small jaw assembly is particularly suitable where rivet sites are difficult to access. The jaw assembly is 100 mm long and the diameter of the steel head sleeve is 18 mm. (max. mandrel Ø 2.7 mm)



**No. 168 0455**

### ANGLE HEAD 90°

For use in very narrow and confined spaces



**No. 146 4882**

### PROTECTIVE SLEEVE

The plastic-dipped steel head sleeve protects sensitive work-piece surfaces (e.g. painted surfaces) from being scratched by the nosepiece or the steel head sleeve during riveting.



**Bird Pro series**  
**No. 156 7289**

# ACCUBIRD®

The well-proven blind rivet setting tools with Li-Ionen energy

No. 143 4898

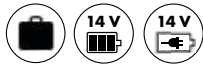

No. 145 7235

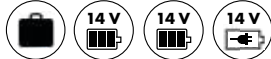

No. 145 7240



No. 145 7230



## TECHNICAL DATA

Stroke:	10,000 N
Weight:	2.0 kg with battery
Traction power:	20 mm
Drive:	DC motor

## SCOPE OF DELIVERY

Nosepieces: 17/24, 17/27, 17/29 and 17/32,  
14V Li-Ion battery 2,0 Ah

## WORKING RANGE

Blind rivets from Ø 2.4 mm aluminium, up to Ø 5 mm all materials and blind rivets up to Ø 6 mm aluminium. (max. mandrel Ø 3.2 mm)

## ADVANTAGES

- Developed and produced in Germany since 1992 by the inventor of the battery blind rivet setting tool
- High speed of operation through automatic resetting of the jaw mechanism immediately after each setting process
- High pulling force for safe setting of blind rivets up to 5 mm diameter in all materials
- Large 20 mm stroke
- Electronic control
- No mechanical switching components
- Electronic temperature and overload protection
- High reliability through low loss power transmission via a highly efficient ball screw drive
- Cablefree tool for flexible operation in installation jobs and industry production

- Auto-reverse function: Immediately after mandrel break-off, this additional operating mode stops the pulling process and moves the jaw assembly back into the initial position. This reduces wear, saves time and energy while making sure the tool is immediately ready for use.

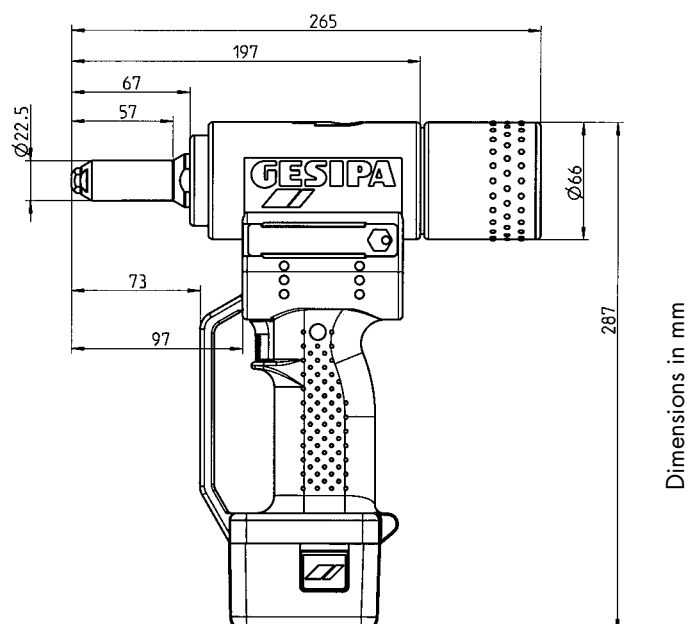

Dimensions in mm

# Rechargeable 14.4 volt riveting tool with Li-ion battery

## NOSEPIECE ASSIGNMENT Power per battery charge

D	Material	approx.pc / battery charge 2.0 Ah Li-Ion battery	Nosepiece	No.
2.4	Alu	<b>1,500</b>	17/18*	<b>143 4976</b>
3.2	CAP®-Alu, CAP®-Cu	<b>1,000</b>	17/18*	<b>143 4976</b>
3 and 3.2	Alu	<b>800</b>	17/24	<b>143 4955</b>
3 and 3.2	Steel	<b>800</b>	17/24	<b>143 4955</b>
3 and 3.2	Stainless steel	<b>800</b>	17/24	<b>143 4955</b>
4	Alu	<b>800</b>	17/24	<b>143 4955</b>
4	Steel	<b>700</b>	17/27	<b>143 4973</b>
4	Stainless steel	<b>650</b>	17/29	<b>143 4974</b>
4.8 and 5	Alu	<b>550</b>	17/29	<b>143 4974</b>
4.8 and 5	Steel	<b>450</b>	17/32	<b>143 4975</b>
4.8 and 5	Stainless steel	<b>350</b>	17/36*	<b>143 4977</b>
6	Alu	<b>250</b>	17/36*	<b>143 4977</b>

### BULB-TITE® Blind rivets

4	Alu	<b>1,000</b>	17/26 BT*	<b>143 4985</b>
5.2	Alu	<b>800</b>	17/32 BT*	<b>143 4986</b>
6.3	Alu	<b>600</b>	17/42 BT*	<b>143 4988</b>
6.3	Steel	<b>300</b>	17/42 BT*	<b>143 4988</b>
			and jaws 4**	<b>143 4173</b>
			and jaw pusher 5**	<b>143 4992</b>

\* available as special accessory. Special design nosepieces are available on request.  
The nosepiece allocation data applies to DIN and GESIPA® blind rivets.

\*\* Available as a complete conversion kit, see spare parts/special accessories on page 100.

**94** Spare parts and special accessories **page 94.**

**130** Extended nosepieces, special lengths and special nosepieces on **page 130.**

**!** BULB-TITES® can only be set with a conversion kit. Jaws need to be changed!  
Conversion kit on **page 94.**

The name of the nosepiece (e.g. 17/32) can be found directly on the nosepiece.



# SPRING-LOADED TRIGGER SYSTEM for AccuBird®

**Process-secure blind riveting even of parts with gaps or recoiling**

**AccuBird®** with spring-loaded trigger system with Nosepieces 17/24, 17/27, 17/29 and 17/32

**No. 145 7232**

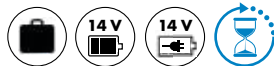

This feature ensures that the materials of the riveting application will be pressed together before the rivet is installed, thus avoiding gaps in between. Moreover the operator will be certain that the rivet has reached its end position in the application and that the setting head is in contact with the upper side of the material. The pressing force can be adjusted variably with springs depending on the application.

## THE FUNCTION

The surface contact trigger mechanism is also installed on the trigger button of the device. It only allows the rivet device to be triggered if a settable compressive force on the part is reached. This ensures that the various components of the application are pressed correctly onto each other before the riveting process. In turn, this means that the uncontrolled deformation of the rivet body between the materials is prevented, which would otherwise go undetected.

The surface contact force may vary in five steps. It is set by either adding or removing springs. This rules out the possibility of unintentionally adjusting the defined surface contact force. Push buttons are arranged in series in front of the standard trigger button. The rivet process can only be triggered by pressing the yellow trigger button when the spring force has been overcome and the defined surface contact force has been reached.

## ENSURING CORRECT PROCESSING OF THE BLIND RIVETS BY MEANS OF A DEFINED CONTACT PRESSURE

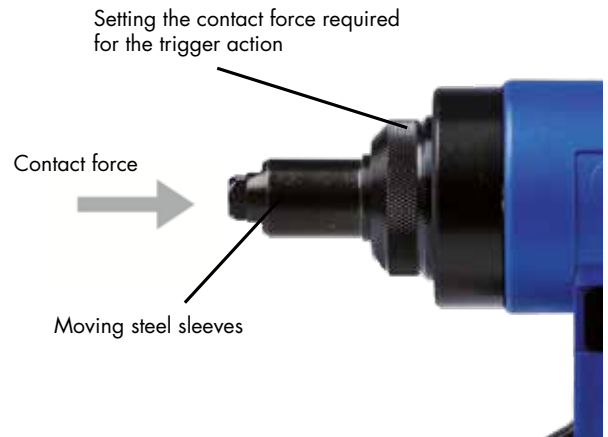

## ACCUBIRD® DIMENSION DRAWING WITH SPRING-LOADED TRIGGER SYSTEM

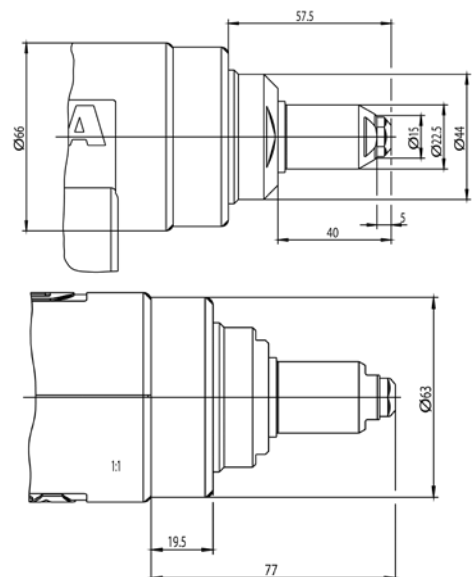

Dimensions in mm



**134**

Nosepieces and performance see **page 134**.

# ANGLE HEAD 90° COMPACT for AccuBird®

Can be swivelled 360° on the AccuBird® tensile axis

No. 145 7252

## TECHNICAL DATA

Weight: 0.7 kg  
Stroke: 20 mm  
Traction power: up to 10 kN

## SCOPE OF DELIVERY

Nosepieces: 17/36



## DESCRIPTION

Using the angle head 90° compact for AccuBird® allows to set all Types of standard blind rivets up to 5 mm in diameter and aluminium up to 6 mm diameter, depending on the tool Type. The minimum edge clearance is 12 mm, the head length is 90 mm. The angle head can be freely fixed in any position around the AccuBird® tensile axis (360° free rotation).

## APPLICATION

The angle head 90° compact is designed for use in tight spaces. Its sturdy design allows it to apply large setting forces when setting blind rivets even in difficult of access work areas with up to 10 kN.

## ADVANTAGES

- Realisation of small edge clearances (12 mm)
- High setting force in tight installation areas (up to 10 kN)
- Large stroke (up to 20 mm)
- Simple assembly
- Compact and robust design
- Simple jaws maintenance
- Use of standard jaws
- Low vibration, even at high breaking force level

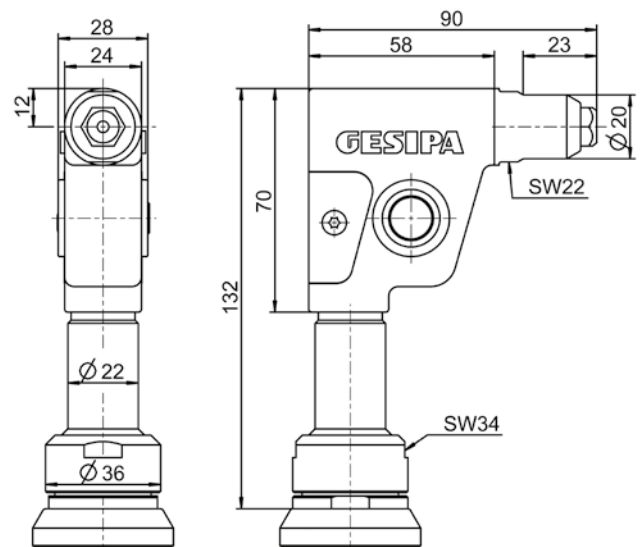

Dimensions in mm

# SPARE PARTS / SPECIAL ACCESSORIES Bird tools

## 14,4 V/2,0 Ah LI-ION BATTERY

Weight: 0.35 kg



NEW

**No. 166 6440**

## 14,4 V/4,0 Ah LI-ION BATTERY

Weight: 0.50 kg



NEW

**No. 166 6441**

## CHARGER 14.4 V LI-ION

### Technical data

Input voltage: 230 V / 50 Hz  
 Output voltage: 14.4 V DC  
 Recharging time: 50 to 100 minutes (battery depending)  
 Weight: 0.6 kg



**No. 145 7282**

## RETAINING NOSEPIECE

Special accessory (also for SN 2)

- Inserted rivet remains in any position
- Rivets may be set with only one hand
- Safer work

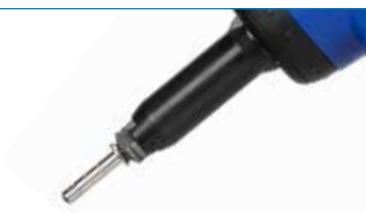

\*Except AccuBird®

17/18R **No. 165 5422**  
 17/20R **No. 165 5424**  
 17/22R **No. 165 5426**  
 17/24R **No. 165 5427**  
 17/27R **No. 165 5428**  
 17/29R **No. 165 5429**  
 17/32R **No. 165 5430**  
 17/36R **No. 165 5431**  
 17/40R\* **No. 165 5433**  
 17/45R\* **No. 165 5434**

## JAWS (3 PARTS)



AccuBird® **No. 143 4958**

## EXTENDED SPENT MANDREL CONTAINER

to suit AccuBird®, PowerBird® and SolarBird®



**No. 143 5034**

## CHANGEOVER SET FOR BULB-TITE® BLIND RIVETS

for AccuBird®



**No. 143 5033**

## PROTECTIVE SLEEVE

The plastic-dipped steel head sleeve protects sensitive workpiece surfaces (e.g. painted surfaces) from being scratched by the nosepiece or the steel head sleeve during riveting.



for AccuBird®  
**No. 156 7288**

# SPARE PARTS / SPECIAL ACCESSORIES Bird tools

## UNIVERSAL NOSEPIECE – 17

To suit AccuBird® and SN2

The universal nosepiece replaces five nosepiece sizes. The integrated rotary star in the steel sleeve can be unlocked easily without tools in order to select the appropriate size of nosepiece

### Working range

Blind rivets from 2.4 up to 5 mm Ø alu, copper and steel and up to 4 mm Ø stainless steel.

### Operation

Operate the tool and hold trigger, then push back adjusting ring to end position (1).

By turning the rotary star (2).



**No. 143 4960**

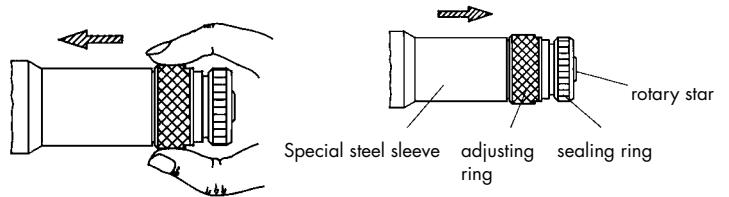

The universal nosepiece includes: Special steel sleeve, complete adjusting ring, rotary star and sealing ring.

2

## EXTENSION UNIT

### ONE-PIECE EXTENSION UNIT

Replaces the steel case, is especially slim and therefore particularly well suited to narrow, hard-to-reach places.



	50 mm	100 mm	150 mm
AccuBird®	145 7273	145 7274	145 0622

### MULTI-PIECE EXTENSION UNITS

For riveted joints in low-lying places. Screwed in between the device and the existing steel case.



	100 mm
AccuBird®	145 7318

### EXAMPLE one-piece

+ SL 50 mm

Steel head sleeve length =  
57 mm (X) + SL 50 mm = 107 mm

**AccuBird®** with spring loaded trigger system

example: + SL 50 mm

Steel head sleeve length =  
40 mm (X) + SL 50 mm = 88 mm

### EXAMPLE multi-piece

+ SL 100 mm

Steel head sleeve length =  
57 mm (X) + SL 100 mm = 157 mm

Variable extension of the steel head sleeve is possible in steps of +100 mm.

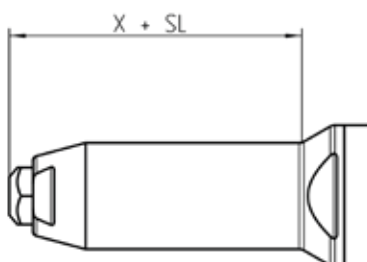

**Dimension X** = Standard steel head sleeve length (with standard nosepiece)

The variable X can be found in the dimension drawings of the devices.

# PNEUMATIC BLIND RIVET SETTING TOOLS

## HYDRO-PNEUMATIC BLIND RIVET SETTING TOOLS

98



102 TAURUS® 1-6



112 TAURUS® 1-4 with counter device



113 TAURUS® 1-4 with counter device eco



114 TAURUS® 1-4 Axial eco  
TAURUS® 1-4 Axial



116 TAURUS® 1-4 C AV

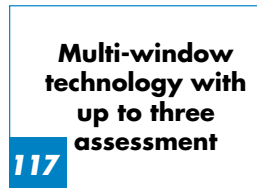

117 TAURUS® WinTech



118 TAUREX 1-6



119 TAUREX 1-4 Axial  
TAUREX 1-4 Axial compact



122 PH 2



123 PH 2-VK



124 PH Axial



142 GAV 8000 / GAV 8000 eco



145 GAV HF



146 Interface 4.0

NEW



# WHAT RIVETS WHAT?

	Energy	Ø mm									
		2.4	3.0	3.2	4.0	4.8	5.0	6.0	6.4	8.0	10.0
PH2	P	X	●	●	●	●	AS				
PH2-VK	P	●	●	●	AS						
PH Axial	P	X	X	X	●	●	AS				
TAURUS® 1, TAUREX 1	P	●	●	●	AS						
TAURUS® 2, TAUREX 2	P				●	●	●	AS			
TAURUS® 3, TAUREX 3	P					●	●	●	●		
TAURUS® 4, TAUREX 4	P					●	●	●	●	●	A

	P	PolyGrip®				G-Bulb		MEGA GRIP® *	BULB-TITE® *	TRI-FOLD®	
		3.2	4.0	4.8	6.4	4.8	6.4			4.1	4.8
PH2	P	●	●	●						●	●
PH2-VK	P	●	AS						●		
PH Axial	P		●	●						●	●
TAURUS® 1, TAUREX 1	P	●	A							●	
TAURUS® 2, TAUREX 2	P	●	●	●						●	●
TAURUS® 3, TAUREX 3	P	●	●	●	AS	●	S	●	●		
TAURUS® 4, TAUREX 4	P	●	●	●	●	●	●	●	●		

**P:** Hydro-pneumatic tool

**X:** Special accessoires required

**A:** Alu/Copper

**S:** Steel

**E:** Stainless Steel / Monel

**Blue box:** All materials(ASE) can be riveted. Where there are exceptions, the letters of the rivetable materials are provided directly in the box.

\*: A special nosepiece is **always** required when setting MEGA GRIP® blind rivets and BULB-TITE® blind rivets.

# THE TAURUS® SERIES

The cost-efficient construction, perfect handling properties and practical accessories are what make the TAURUS® series so unique and flexible.

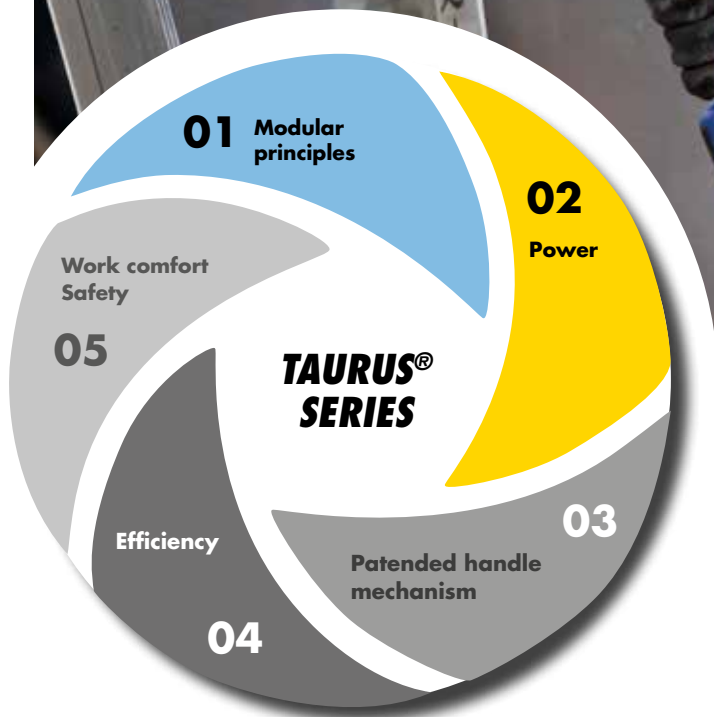

Since the market introduction of the **TAURUS® 2** in the year 2002, the TAURUS® series has managed to convince thousand times over in trade and industry. The TAURUS® 2 especially is a true all-rounder.

**TAURUS** 



**TAURUS® 1**



**TAURUS® 2**



**TAURUS® 3**



**TAURUS® 4**



**TAURUS® 5**



**TAURUS® 6**

# ADVANTAGES WHICH SIMPLY CANNOT FAIL TO CONVINCE YOU!

## 01 MODULAR PRINCIPLES

- Widest possible parts commonality – low spare part stocks required and simple maintenance
- Flexible adaption to new applications

## 02 POWER

- High setting forces combined with low weight
- Fast work cycle
- Optimised stroke for the entire series

## 03 PATENTED HANDLE MECHANISM\*

- With forcibly actuated jaws by pneumatic pressing
- Safe, non-slip gripping of the rivet mandrel
- Just one model of jaws for all tools
- Very long service lives

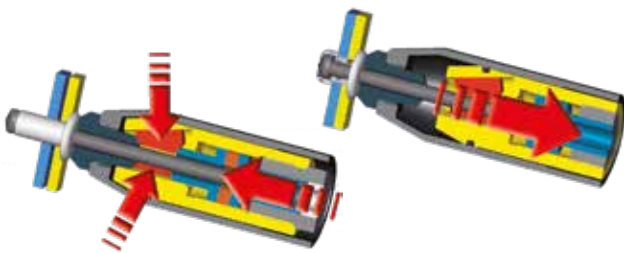

\* Patented jaw system

- > The three jaws move in separate channels while being under forced control.
- > The jaws are pressed onto the mandrel by using compressed air instead of spring force – the force being ten times higher than usual.
- > Due to the high pressure the jaws immediately cling to the mandrels upon triggering the riveting process, only then the pulling movement starts.

GESIPA®-system – decisive advantages

- > The complete stroke of the tool is used for setting the rivet guaranteeing a reliable setting process.
- > The immediate and non-slip grip of the mandrel reduces abrasion and troublesome soiling.
- > Since the jaws do not slide along the mandrel, the wear and tear of the jaw profiles is reduced.

Lower costs due to longer service life and low requirements regarding maintenance and spare parts needed.

## 04 EFFICIENCY\*\*

- Little compressed air consumption thanks to dual function: setting the rivets and extracting the spent mandrels use the same air
- Air suction needed only for vertical downwards riveting.
- Can be permanently switched-off if not needed.

### \*\* Optimum use of compressed air ensures maximum efficiency and low operating costs

Compressed air is used very often in industrial production because of its flexibility. It does, however, cause relatively high costs and its consumption damages the environment. These disadvantages are more than enough reason for GESIPA® to equip the TAURUS® tool series with a special technique that allows to save compressed air and is unique throughout the world. The GESIPA® System uses the compressed air required for the setting process twice. First, to set the blind rivet and secondly, to extract the spent mandrel. Dual use of the compressed air means no expensive, fresh compressed air is needed which other tools on the market constantly need just to extract the spent mandrel. And, last but not least, noise emission from the TAURUS®-tools is extremely low.



In two-shift operation and with compressed air costs of approximately € 0.03 per m<sup>3</sup> this innovative technique allows savings of up to € 720 per year and tool. A TAURUS® 2 can pay for itself in less than one year.

## 05 WORK COMFORT / SAFETY

- Rubberised, moulded grip
- Balanced center of gravity
- Low-vibration and soundproof
- Little activation force required
- Spent mandrel container with swivelling air deflector
- Overpressure valve for prevention of overload
- Integrated protection feature prevents the ejection of spent mandrels while the spent mandrel container is removed

# TAURUS® DEVICE SERIES – THE MODULAR CONCEPT

The TAURUS® series – unique modular principle. Minimal spare parts stocks, easy maintenance

## Extension units

Free access to difficult-to-reach riveting points



Single-piece  
(different sizes)



Multi-piece  
(different sizes)

## Nosepieces

different sizes



## Hanger

## Spring-loaded trigger system

for gap-free riveting



## External trigger

for external triggering



## Air suction function

## Nosepiece allocation



GESIPA®-Interface

## Setting process monitoring

for reliable setting processes



## The TAURUS® device series – Versatile accessories complete the range

The modular concept for the TAURUS® series 1-4 lets the user customise the TAURUS® devices to match his individual requirements.

Many identical parts that can be used across all devices reduce the need to stock spare parts and make maintenance easy. This wide range of options provides the user with a high degree of flexibility. Each device in the TAURUS® series 1-4 can be fitted with many different spare parts or refitted according to the application.

### Tool mount

for integration into automated applications



### Rivet mandrel evacuation



### Blind rivet counters



GRiv-Count



GRiv-Amp

### Spent mandrel container

adoptable for TAURUS® tools 1-4



TAURUS® 1-2



TAURUS® 3-4



PH-2000

### Swivel air connector



### Counter eco



### Flexible base

Optimized stability



# TAURUS® SERIES



With silencer

## TAURUS® 1

No. 145 7665

### TECHNICAL DATA

Weight:	1.3 kg
Operating air pressure:	5-7 bar
Air hose connection:	6 mm Ø (1/4")
Air consumption:	approx. 1.0 ltr. per rivet
Traction power:	5,500 N at 6 bar
Stroke:	15 mm

### WORKING RANGE

Sets blind rivets from 2.4 up to 3.2 mm  
 Ø all materials and up to 4 mm Ø alu/steel  
 (max. mandrel Ø 2.5 mm)

### SCOPE OF DELIVERY

Nosepieces: 17/18, 17/20 and 17/22,  
 maintenance wrench SW12/14, SW14/17,  
 1 hydraulic oil bottle 100 ml, 1 oil refill can,  
 Operating instructions with spare parts list

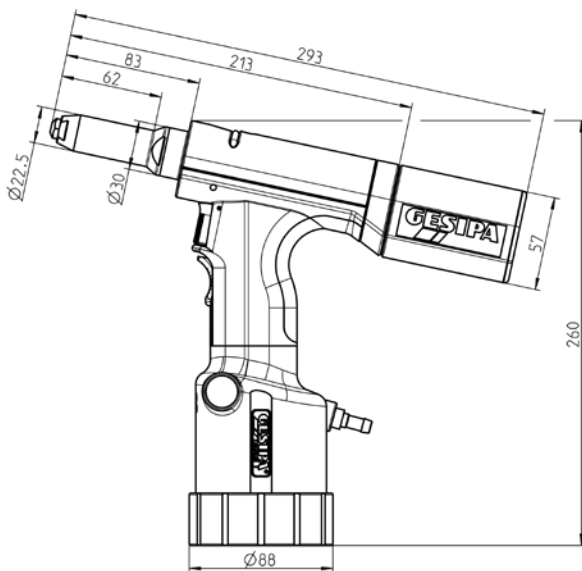

Dimensions in mm



## TAURUS® 2

No. 145 7771

### TECHNICAL DATA

Weight:	1.6 kg
Operating air pressure:	5-7 bar
Air hose connection:	6 mm Ø (1/4")
Air consumption:	approx. 2.3 ltr. per rivet
Traction power:	11,000 N at 6 bar
Stroke:	18 mm

### WORKING RANGE

Sets blind rivets up to 5 mm Ø all materials and up  
 to 6 mm Ø alu/steel (max. mandrel Ø 3.2 mm)

### SCOPE OF DELIVERY

Nosepieces: 17/24, 17/27, 17/29 and 17/32,  
 maintenance wrench SW12/14, SW14/17,  
 1 hydraulic oil bottle 100 ml, 1 oil refill can,  
 Operating instructions with spare parts list

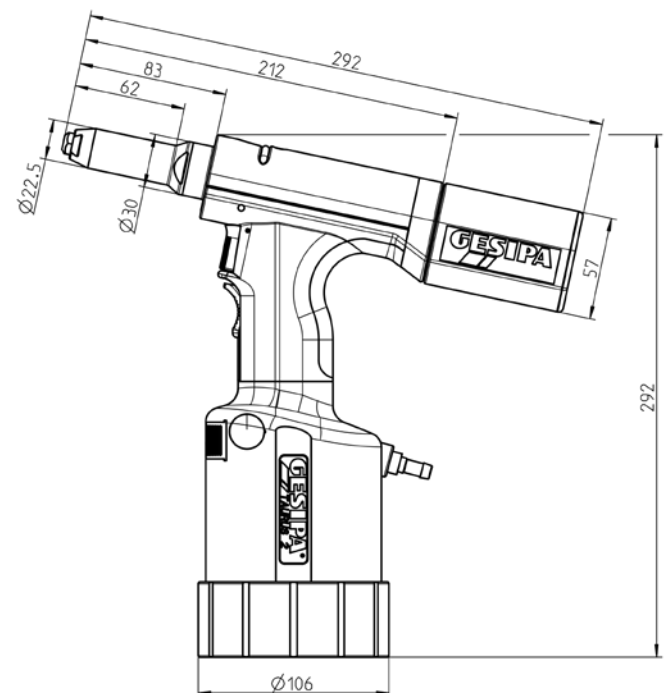

Dimensions in mm

## Pneumatic-hydraulic blind rivet setting tools



### TAURUS® 3

**No. 145 7871**

#### TECHNICAL DATA

Weight:	1.9 kg
Operating air pressure:	5-7 bar
Air hose connection:	6 mm Ø (1/4")
Air consumption:	approx. 4.8 ltr. per rivet
Traction power:	18,000 N at 6 bar
Stroke:	25 mm

#### WORKING RANGE

Sets blind rivets up to 6.4 mm Ø all materials (max. mandrel Ø 4.3 mm)

#### SCOPE OF DELIVERY

Nosepieces: 17/36, 17/40 and 17/45, maintenance wrench SW12/14, SW14/17, 1 hydraulic oil bottle 100 ml, 1 oil refill can, Operating instructions with spare parts list

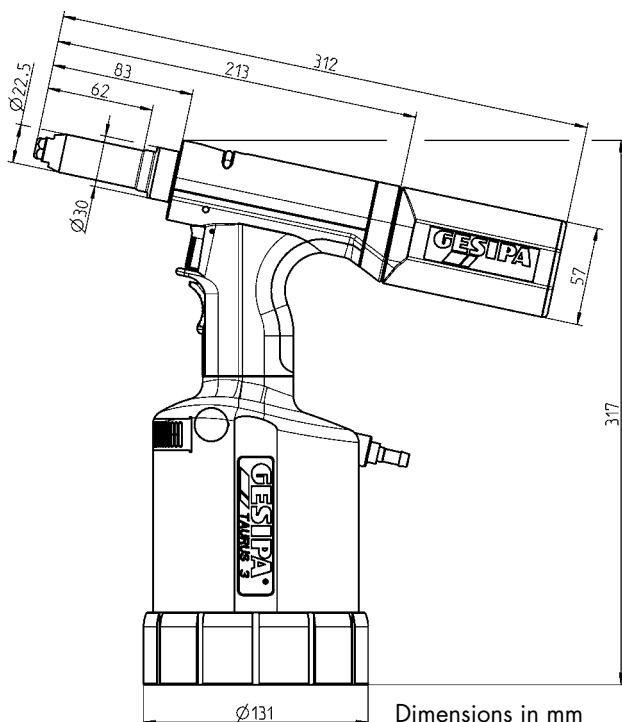

### TAURUS® 4

**No. 145 7964**

#### TECHNICAL DATA

Weight:	2.0 kg
Operating air pressure:	5-7 bar
Air hose connection:	6 mm Ø (1/4")
Air consumption:	approx. 4.8 ltr. per rivet
Traction power:	23,000 N at 6 bar
Stroke:	19 mm

#### WORKING RANGE

Sets blind rivets up to 6.4 mm Ø all materials and BULB-TITE®-rivets up to 7.7 mm Ø all materials (max. mandrel Ø 4.3 mm)

#### SCOPE OF DELIVERY

Nosepieces: 17/36, 17/40 and 17/45, maintenance wrench SW12/14, SW14/17, 1 hydraulic oil bottle 100 ml, 1 oil refill can, Operating instructions with spare parts list

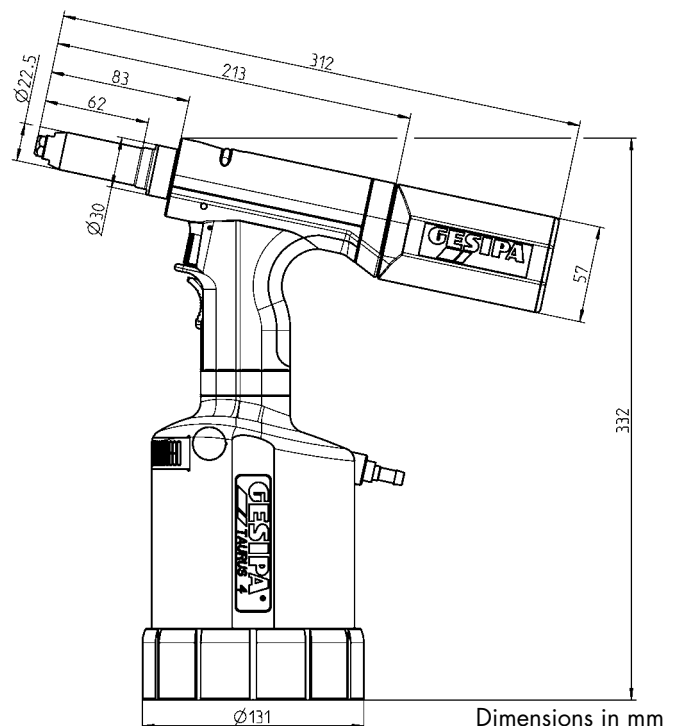

# TAURUS® SERIES



## TAURUS® 5

Basic tool  
No. 145 8002



## TAURUS® 6

Basic tool  
No. 145 8022

### TECHNICAL DATA

Weight: 3.4 kg  
Operating air pressure: 5-7 bar  
Air hose connection: 6 mm Ø (1/4")  
Air consumption: approx. 6.9 ltr. per rivet  
Traction power: 42,000 N at 7 bar  
Stroke: 17 mm

### WORKING RANGE

Blind rivets above 6.4 mm Ø all materials and lockbolts up to 10 mm Ø with corresponding pulling heads (look on page 125).

### SCOPE OF DELIVERY

1 hydraulic oil bottle 100 ml  
1 oil refill can  
Operating instructions with spare parts list

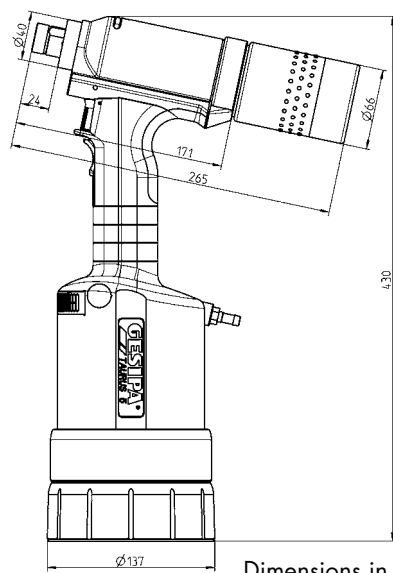

Dimensions in mm

TAURUS® 5 and 6 need to be fitted with nosepieces to match the application. Will be produced on request.



125

The pulling heads can be found on page 125.

### TECHNICAL DATA

Weight: 3.4 kg  
Operating air pressure: 5-7 bar  
Air hose connection: 6 mm Ø (1/4")  
Air consumption: approx. 6.9 ltr. per rivet  
Traction power: 50,000 N at 7 bar  
Stroke: 15 mm

### WORKING RANGE

Blind rivets above 6.4 mm Ø all materials and lockbolts up to 10 mm Ø with corresponding pulling heads (look on page 125).

### SCOPE OF DELIVERY

1 hydraulic oil bottle 100 ml  
1 oil refill can  
Operating instructions with spare parts list

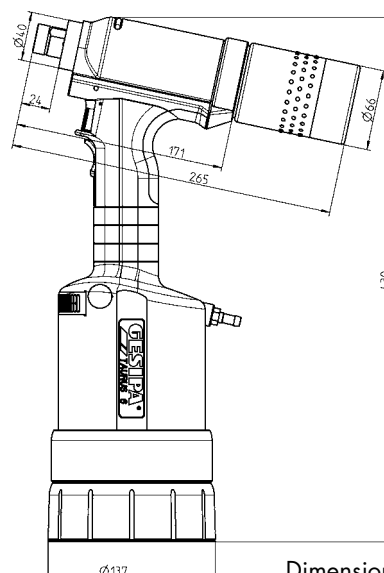

Dimensions in mm

TAURUS® 5 and 6 need to be fitted with nosepieces to match the application. Will be produced on request.



125

The pulling heads can be found on page 125.



## NOSEPIECES



### For long mandrels, special blind rivets and other challenges

The use of the correct nosepiece is essential for ensuring reliable riveting and a neat riveted joint. A large selection of standard and special nosepieces makes it possible to quickly adapt to various types of blind rivet. Even special versions are generally available on request. All nosepiece allocation data relate to DIN and GESIPA® blind rivets.

The name of the nosepiece (e.g. 17/32) can be found directly on the nosepiece.



**128**

Extended nosepieces, special lengths and special nosepieces on **page 128**.

3

## NOSEPIECE ASSIGNMENT

D	Material	Nosepiece	No.
<b>STANDARD</b>			
2.4	Alu	17/18	<b>143 4976</b>
3.2	CAP®-Alu, CAP®-Cu	17/18	<b>143 4976</b>
3	Alu/Cu	17/20	<b>143 4994</b>
3	Alu, Cu, Steel, Stainless steel, Stinox, Alu/Alu	17/22	<b>143 5018</b>
3 and 3.2	Alu, Cu, Steel, Stainless steel, Stinox, PG-Alu, PG-Steel, PG-Stainless steel	17/24	<b>143 4955</b>
4	Alu, Cu, CAP®-Alu, CAP®-Cu	17/24	<b>143 4955</b>
4	Steel, Alu, PG-Alu	17/27	<b>143 4973</b>
4	Stainless steel, Stinox, PG-Steel, PG-Stainless steel	17/29	<b>143 4974</b>
4.8 and 5	Alu, CAP®-Alu, CAP®-CU, PG-Alu	17/29	<b>143 4974</b>
4.8 and 5	Steel, Alu	17/32	<b>143 4975</b>
4.8 and 5	Stainless steel, Stinox, PG-Steel, PG-Stainless steel, G-Bulb	17/36	<b>143 4977</b>
6	Alu	17/36	<b>143 4977</b>
6	Steel	17/40	<b>143 4999</b>
6.4	Alu	17/40	<b>143 4999</b>
6.4	Steel, Alu, Stainless steel, PG-Stainless steel, G-Bulb	17/45	<b>143 4860</b>
8	Alu	17/45	<b>143 4860</b>
<b>BULB-TITE®</b>			
4	Alu	17/26 BT	<b>143 4985</b>
5.2	Alu	17/32 BT	<b>143 4986</b>
6.3	Alu, Steel, Monel	17/42 BT	<b>143 4988</b>
7.7	Alu	17/48 BT	<b>143 4989</b>
<b>MEGA GRIP®</b>			
4.8	Alu, Steel, Stainless steel	17/31 MG	<b>143 4993</b>
6.4	Alu, Steel, Stainless steel	17/41 MG	<b>143 4865</b>
<b>PLASTIC</b>			
3	Plastic	17/30 K	<b>143 4933</b>
4	Plastic	17/35 K	<b>143 5824</b>
5		17/40 K	<b>143 4998</b>

# SPARE PARTS / SPECIAL ACCESSORIES TAURUS® SERIES 1-4

## SWIVEL AIR CONNECTOR

For the complete TAURUS® series in 1/8"



**No. 143 5479**

## SET OF JAWS (3 PCS.)

Patented jaw system for the complete TAURUS® series



**No. 143 5568**

## FLEXIBLE BASE FOR TAURUS® 1 AND 2

With the flexible base made from MBR and the larger surface area, the TAURUS® tools are standing even more stably.

for TAURUS® 1

for TAURUS® 2



**T1 No. 143 6394**

**T2 No. 143 6371**

## SMALL JAW ASSEMBLY TAURUS® 1-2

The small jaw assembly is particularly suitable where rivet sites are difficult to access. The TAURUS® 1 with the small jaw assembly handles aluminium/steel blind rivets up to Ø 4 mm and steel/steel blind rivets up to Ø 3.2 mm. The small jaw assembly for the TAURUS® 2 handles aluminium/steel blind rivets up to Ø 5 mm and steel/steel blind rivets up to Ø 4 mm. The jaw assembly is 100 mm long and the diameter of the steel head sleeve is 18 mm.

**T1 No. 145 7705**

**T2 No. 145 7846**

## Nosepieces to be used

NOSEPIECE	TAURUS® 1	TAURUS® 2
10/18	<b>143 4055</b>	<b>143 4055</b>
10/24	<b>143 4061</b>	<b>143 4061</b>
10/27	-	<b>143 4062</b>
10/29	-	<b>143 4064</b>



## TOOL MOUNT FOR TAURUS® 1-4

For integration into automated systems or connection to handling modules.

\*Device support not available individually. The tool is delivered pre-mounted on a new device or can be retrofitted on an existing device at the GESIPA® Walldorf site.



Can only be mounted by GESIPA®



**No. 143 5538\***

## PROTECTIVE SLEEVE

The plastic-dipped steel head sleeve protects sensitive workpiece surfaces (e.g. painted surfaces) from being scratched by the nosepiece or the steel head sleeve during riveting.



for **TAURUS® standard tools No. 156 7289**

## TRANSPARENT COLLECTING CONTAINER FOR TAURUS® 1-4

The classic residual mandrel collecting container in the TAURUS® series is also available in a transparent version. The transparent collecting container allows the amount of residual mandrels to be monitored constantly.

The transparent collecting container will be available in a small version for the TAURUS® devices 1-2 and a large version for the TAURUS® devices 3-4.



**T1-T2 No. 145 7744**

**T3-T4 No. 145 7951**

3

## MANDREL EXTRACTION TUBE

For the full TAURUS® series

By attaching a special-purpose hose nipple, the spent mandrel container can be replaced by the spent mandrel evacuation hose\*. In stationary use, this can be of great advantage as frequent disposal is not required. The spent mandrels are collected in a container so that the work place remains clean and tidy, with no interruption to the work.

\*The use of TAURUS® tools with a 1.5 m long evacuation hose requires permanent employment of the suction unit.



**No. 145 7864**

## TAURUS® CONVERSION KIT

For conversion to the PH 2000 spent mandrel container (description and full offer on page 121).



**T1 No. 145 7700**

**T2-T4 No. 145 7703**

# SPARE PARTS / SPECIAL ACCESSORIES TAURUS® SERIES 1-4

## EXTENSION UNITS

### Allows easy access to rivet sites which are difficult to reach.

The extension units are used for riveting sites which are situated low down or are difficult to access. We offer one-piece extension units of 35, 85, 135 and 185 mm length for the TAURUS® 1-4.

The extension units consist of three parts.

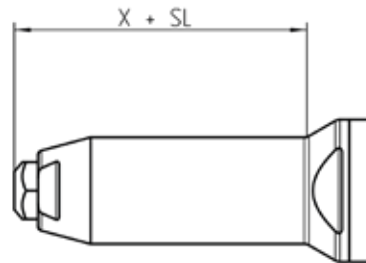

The variable X can be found in the dimension drawings of the devices.

**Dimension X** = Standard steel head sleeve length (with standard nosepiece)

### ONE-PIECE

Example: TAURUS® 1 + SL 35 mm

Steel head sleeve length =  
62 mm (X) + SL 35 mm = 97 mm



TOOL	+35 mm	+85 mm	+135 mm	+185 mm
TAURUS® 1	<b>146 4345</b>	<b>146 4346</b>	<b>146 4347</b>	-
TAURUS® 2	<b>145 8042</b>	<b>146 4350</b>	<b>146 4351</b>	<b>146 4352</b>
TAURUS® 3 and 4	<b>145 7932</b>	<b>145 7933</b>	<b>145 7937</b>	-

TOOL	+ 50 mm	+ 100 mm
TAURUS® 1 with spring loaded trigger system	<b>145 0880</b>	<b>145 7727</b>
TAURUS® 2 with spring loaded trigger system	<b>145 7857</b>	<b>145 7858</b>
TAURUS® 3 and 4 with spring loaded trigger system	<b>145 7959</b>	<b>145 7960</b>

### MULTI-PIECE

Example: TAURUS® 1 + SL 100 mm

Steel head sleeve length = 62 mm (X) + SL 100 mm = 162 mm  
On TAURUS® 1-4 the steel head sleeve can be extended variably in steps of 100 mm.

TOOL	+100 mm
TAURUS® 1	<b>145 7743</b>
TAURUS® 2	<b>145 7848</b>
TAURUS® 3 and 4	<b>145 7947</b>



## ANGLE HEAD 90° AND ANGLE HEAD 90° COMPACT

The **angle head 90°** and the **angle head 90° compact** are designed for use in tight spaces. Its sturdy design allows it to apply large setting forces when setting blind rivets even in difficult of access work areas. The angle head 90° for TAURUS® 1-4 allows to set all Types of standard blind rivets up to Ø 6.4 mm all materials and Ø 8 mm alu, depending on the tool type. The minimum edge clearance is 15 mm, the head length is 110 mm.

### ANGLE HEAD 90° for TAURUS® 1-4

#### TECHNICAL DATA

Weight: 1.1 kg  
Stroke: 20 mm (TAURUS® 1,2 and 4)  
Stroke: 25 mm (TAURUS® 3)  
Traction power: up to 20 kN

#### SCOPE OF DELIVERY

Nosepiece 17/45 WK  
Jaws up to rivet-Ø 4mm (Nosepiece 17/24)

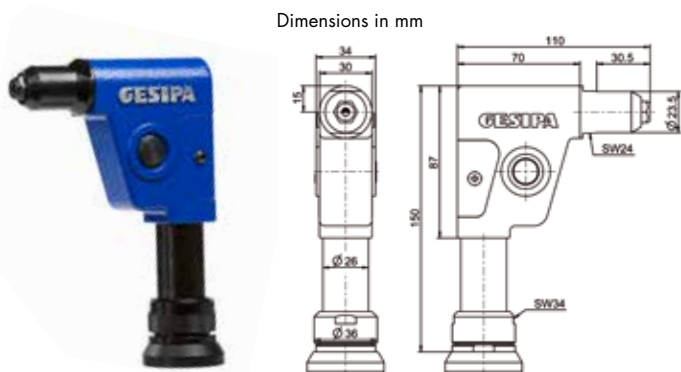

**TAURUS® 1, 2, 4** No. 155 9513  
**TAURUS® 3** No. 155 9512

#### JAWS (3 PARTS) for TAURUS® 1-4

rivet-Ø 4.0 mm up to Ø 6.4 mm of all materials,  
Ø 8.0 mm Alu

**No. 143 4173**

rivet-Ø 2.4 mm up to 4 mm (Nosepiece 17/24)

**No. 143 4958**



The angle head 90° compact for the TAURUS® 1 and 2 allows to set standard blind rivets of all Types of material up to 5 mm in diameter and alu/steel blind rivets up to 6 mm in diameter, depending on the tool Type. The minimum edge clearance is 12 mm, the head length is 90 mm. Both angle heads can be freely fixed in any position around the TAURUS® tensile axis (360° free rotation).

### ANGLE HEAD 90° COMPACT for TAURUS® 1-2

#### TECHNICAL DATA

Weight: 0.7 kg  
Stroke: 20 mm  
Traction power: up to 10 kN

#### SCOPE OF DELIVERY

Nosepieces: 17/36



**TAURUS® 1, 2** No. 145 7921

#### JAWS (3 PARTS) for TAURUS® 1-2

**No. 143 4958**

# TAURUS® VERSIONS

A wide variety of options means higher flexibility. All of the TAURUS® varieties are customized and designed and made to fit the application. Please contact our team from the Technical Sales department should you require individual advice or have any further queries or need information on prices.



**TAURUS® versions** – Safe, individual, versatile!

## TAURUS® 2/K



**No. 145 7804**

The TAURUS® 2/K has been designed for setting plastic rivets. In its functionality the TAURUS® 2/K is identical to the standard tool, however has a stroke of 24 mm instead of 18 mm. Plastic rivets only need a low setting force, however, normally require large setting strokes due to the toughness of the plastic material. The TAURUS® 2/K allows to safely set plastic rivets with only one setting stroke! The TAURUS® 2/K comes with 3 nose pieces for plastic rivets 17/30 K, 17/35 K and 17/40 K included.

### TECHNICAL DATA

Strength: 24 mm  
Tensile strength: 8,400 N

### WORKING RANGE

Blind rivets plastic from 4 up to 6 mm Ø.

### SCOPE OF SUPPLY

Nosepieces 17/30K; 17/35K; 17/40K



3

## TAURUS® 2/AS



**No. 145 7794**

The TAURUS® 2/AS is a special version of the TAURUS® 2 with a VAS slide switch which does not engage when in its highest position, thus achieving that vacuum absorption is automatically deactivated once the tool is not in use. This way, unintentional activation of the vacuum absorption with unnecessary air consumption can be effectively avoided.

Other TAURUS® sizes upon request.

## TAURUS® 2/24

**No. 145 7803**

As far as technology and functionality are concerned, the TAURUS® 2/24 is identical to the standard tool, however has a stroke of 24 mm instead of 18 mm. This tool provides the advantage of being able to safely set critical rivet Types requiring a large setting stroke with only one setting stroke without re-engagement. This applies, for example, to our BULB-TITE® or similar rivets.

### TECHNICAL DATA

Strength: 24 mm  
Tensile strength: 8,400 N

### WORKING RANGE

Blind rivets up to Ø4 mm all materials,  
Ø5 mm steel; Ø 6 mm alu.

**TAURUS® versions** – Safe, individual, versatile!

## **TAURUS® 1-4 WITH COUNTER DEVICE**



TAURUS® 1-4 (with counter device)



GRiv-Count



GRiv-Amp



**The TAURUS® series 1-4 with counter device – detects and counts the spent mandrels**

The tools are equipped with a sensor which detects and counts the spent mandrels after the setting process has been finished. The sensor is positioned on the tool head in front of the spent mandrel container.

For a completely independent workstation, the amplifier GRivAmp or the counter and display unit GRivCount can be used for processing and analysing the signals.

For retrofitting existing tools a conversion kit suitable for all TAURUS® Types (except TAURUS® with PH 2000 spent mandrel container) is available:

**Conversion kit TAURUS® 1 with sensor**  
**No. 145 7698**

**Conversion kit TAURUS® 2-4 with sensor**  
**No. 151 6858**

**GRiv-Count**  
**No. 146 3062**

**GRiv-Amp**  
**No. 145 7699**

**!** Power supply (24 V) is to be provided on site.



## **TAURUS® 1-4 WITH COUNTER ECO**

**TAURUS® 1-4 with counter – the cost-effective variant for monitoring the number of setting strokes**

In contrast to the TAURUS® with counter, the eco counter only counts the number of setting strokes and not the spent mandrels. The sensor is fitted on the air cylinder. The counter is not available on its own. It is supplied mounted on a new tool or it can be retrofitted at the Walldorf factory.



3

### **Retrofit kit for the eco counting device**

<b>TOOL</b>	<b>No.</b>
TAURUS® 1	<b>145 0892</b>
TAURUS® 2	<b>145 0933</b>
TAURUS® 3	<b>145 0963</b>
TAURUS® 4	<b>145 0993</b>

\*eco counting device is not available separately. It can be retrofitted to an existing tool at the Walldorf plant or in a qualified GESIPA® workshop.



Can only be mounted by GESIPA®.

**The TAURUS® series 1-4  
in axial version – for  
special applications**

## TAURUS® 1-4 AXIAL

### TECHNICAL DATA

Operating pressure: 5 to 7 bar  
Air hose connection: 6 mm (1/4")  
Noise emission: max. 79 dB  
Vibrations: < 2.9 m/s<sup>2</sup>

#### Weight:

TAUREX 1 Axial compact 3.1 kg  
TAUREX 2 Axial compact 3.4 kg  
TAUREX 3 Axial compact 3.7 kg  
TAUREX 4 Axial compact 4.1 kg

### APPLICATIONS

The special pistols of TAURUS® Axial offer the option of installation in production systems and simultaneously allow flexible and handheld ergonomic work in applications with restricted accessibility that require a vertical, downwards oriented riveting action.

In order to ensure that no gap is left between the components to be riveted and the setting head effectively makes contact with the application, the TAURUS® Axial can be additionally supplied with a spring loaded-trigger system. A compressed air supply is additionally required for reliable mandrel evacuation. Depending on the application, this is preferably achieved via the balancer with valve or the time delay valve (see page 125).

### WORKING RANGE

- Processing blind rivets up to 6.4 mm Ø all materials and up to 8 mm Ø alu (max. mandrel dia. 4.5 mm)
- Same performance and technical data as the respective individual units in the TAURUS® series 1-4



### ADVANTAGES

- Pressure transducer attached in a space-saving manner directly to the device, i.e. also for applications in tight spaces
- Technical design close to the TAUREX Axial
- Also perfectly designed for fixed installation in production lines or semi-automatic workstations
- Very practical for processing blind rivets in positions that require a vertical rivet setting process
- The tool can be equipped with almost all TAURUS® series options: e.g. extension units, blind rivet counter, spring loaded trigger system and remote control
- The handle in the rivet axis allows ergonomic work – especially in vertical applications
- Can be suspended on a balancer

TOOL	No.
TAURUS® 1 Axial	<b>145 7682</b>
TAURUS® 2 Axial	<b>145 7795</b>
TAURUS® 3 Axial	<b>145 7893</b>
TAURUS® 4 Axial	<b>145 0981</b>
TAURUS® 1 Axial with spring-loaded trigger system	<b>145 7683</b>
TAURUS® 2 Axial with spring-loaded trigger system	<b>145 7796</b>
TAURUS® 3 Axial with spring-loaded trigger system	<b>145 7894</b>
TAURUS® 4 Axial with spring-loaded trigger system	<b>145 0982</b>

**TAURUS® versions** – Safe, individual, versatile!

The **TAURUS®-series 1-4** in axial version – the cost-efficient introductory version for special applications

## TAURUS® 1-4 AXIAL ECO

### TECHNICAL DATA

Operating air pressure:	5 to 7 bar
Air hose connection :	6 mm (1/4")
Noise emission:	max. 79 dB
Vibrations:	< 2.9 m/s <sup>2</sup>
Weight:	
TAURUS® 1 Axial eco	2.0 kg
TAURUS® 2 Axial eco	2.3 kg
TAURUS® 3 Axial eco	2.6 kg
TAURUS® 4 Axial eco	3.0 kg

### APPLICATIONS

Analog to the TAURUS® 1-4 Axial (S. 119)

### WORKING RANGE

Analog to the TAURUS® 1-4 Axial

### ADVANTAGES

Analog to the TAURUS® 1-4 Axial

### ADDITIONAL ADVANTAGES

- Cost-efficient basic version
- Integrated mandrel evacuation for disposal of the spent mandrel



3

TOOL	No.
TAURUS® 1 Axial eco	<b>145 7676</b>
TAURUS® 2 Axial eco	<b>145 7798</b>
TAURUS® 3 Axial eco	<b>145 7898</b>
TAURUS® 4 Axial eco	<b>145 7980</b>
TAURUS® 1 Axial eco with spring-loaded trigger system	<b>145 7677</b>
TAURUS® 2 Axial eco with spring-loaded trigger system	<b>145 7799</b>
TAURUS® 3 Axial eco with spring-loaded trigger system	<b>145 7899</b>
TAURUS® 4 Axial eco with spring-loaded trigger system	<b>145 7981</b>

**TAURUS® versions** – Safe, individual, versatile!

**TAURUS® 1-4 C AV -  
with integrated setting  
process monitoring**

## TAURUS® 1-4 C AV

Setting process monitoring is achieved by direct real-time analysis of traction force and traction course recorded during the setting of the rivet. All system components necessary for this operation are integrated in the tools. Analysing a setting process takes less than 1  $\mu$ s. The results are directly shown by a green or red LED installed in the tool base and optionally by an acoustic signal. In addition to this individual analysis the system also provides collective analysis for the complete workpiece. The tool stores more than 260,000 setting process data which can be retrieved at any time. The system also identifies failure patterns and memorizes them for failure analysis and troubleshooting. The tools can be operated as stand-alone devices or as integrated part of a customer's production system via the GESIPA® interface.

### GESIPA®-INTERFACE 4.0

The GESIPA-Interface has been developed in-house at GESIPA® based on an embedded PC system. It features 16 digital inputs and outputs for communication with a PLC. Other new features compared to the Interface 2.0 are:

- 2 x Ethernet interfaces, router functions
- 1 x USB and 1 x USB-OTG
- Screen connection, graphic output via DVI
- Wi-Fi, as access point and as client, Wi-Fi router function
- Local OLED display to show status and error messages
- M.2 SSD interface, the module can be retrofitted with an SSD (large databases)
- PCIe connector for Hilscher netJACK modules (i.e. direct connection to industrial buses such as PROFINET, SERCOS and EtherCAT possible)



TAURUS® C 1-4 (with setting process monitoring)

### HIGH-GRADE GESIPA® BLIND RIVET WITH MINIMAL SCATTER:

- Minimal scatter of the graphs
- All graphs end in the break-off window
- 20x OK riveting

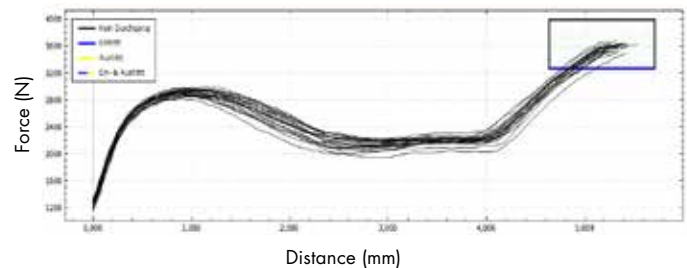

**TAURUS® versions** – Safe, individual, versatile!

**WinTech – multi-window technology with up to three assessment windows**

## TAURUS® WINTECH

Ideal for demanding joining technology used for safety components such as in the aviation industry. The basis for monitoring the WinTech setting process is the tried and tested TAURUS® C. The setting process is evaluated with the aid of position and force sensors as well as integrated electronic circuitry. Up to three evaluation windows can be configured with special setup software. A coloured LED on the tool shows the result of setting process monitoring. With a data line, the values can also be recorded and further processed.

Consultation, price and delivery time on request

### APPLICATION

In the production of critical components as well as in automatic setting processes, the TAURUS® C can facilitate monitoring and documentation of the results.

### ADVANTAGES

- High process reliability
- Documentation of each individual setting operation
- Less scrap as faults are detected immediately
- Avoidance of additional costs/quality costs due to NOK parts
- The customer can configure how to enter and exit the assessment window
- Flush-break rivets (MEGA GRIP®) can also be monitored

### EXAMPLE OF OK PROCESS

Window entry and exit at customer-defined positions

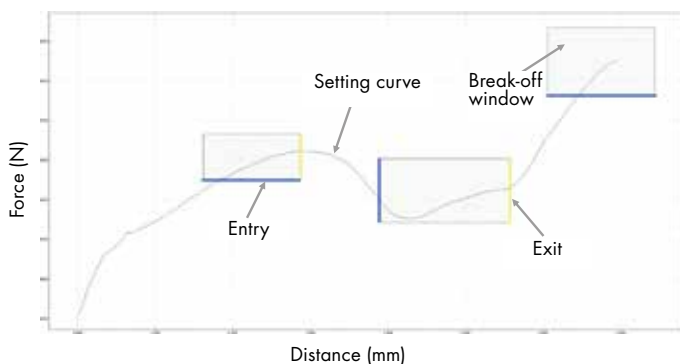

### EXAMPLE OF NOT OK PROCESS

Material to be joined too thin due to missing compo-

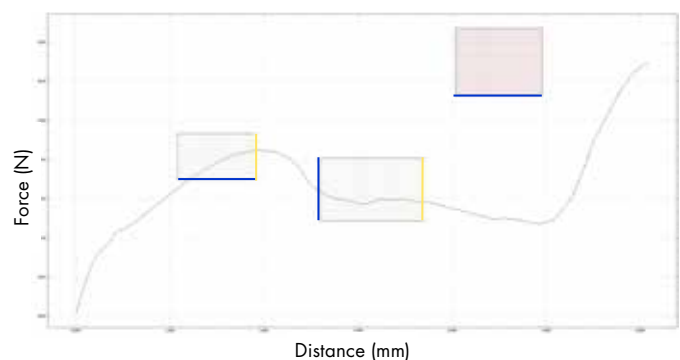

**TAURUS® versions** – Safe, individual, versatile!

**The whole TAURUS® series with remote pressure transducer – for even more flexibility, versatility and ergonomy**

## TAUREX 1-6

### COMMON TECHNICAL DATA

Operating air pressure: 5 to 7 bar  
Air hose connection: 6 mm (1/4")  
Noise emission: max. 79 dB  
Vibrations: < 2.9 m/s<sup>2</sup>

### WORKING RANGE

- All blind rivets and lockbolts up to a mandrel
- breaking force of 50 kN
- Same performance and technical characteristics as the respective individual units in the TAURUS® series 1-4, 5-6 with different stroke
- 3 metres hose length between pressure transducer and setting pistol

### ADVANTAGES

- Low weight of the hand held tool
- Tubing connection with quick-connect feature (upon request) on the pressure transducer side:
- No oil leak and no air bleeding
- Ideally suited for setting of blind rivets and lockbolts in poorly accessible locations
- Also perfectly designed for fixed installation in production lines or semi-automatic workstations
- Can be combined with almost all supplements and options of the TAURUS® series: head extensions, mandrel containers, rivet counting units, process control, pressure trigger and remote control



TOOL	No.
TAUREX 1	<b>145 8025</b>
TAUREX 2	<b>145 8031</b>
TAUREX 3	<b>145 8044</b>
TAUREX 4	<b>145 8058</b>
TAUREX 5*	<b>145 8060</b>
TAUREX 6*	<b>145 8062</b>

\*TAUREX 5 and 6 tools must be equipped with heads that are specially designed for their application field. Production on request.

**TAURUS® versions** – Safe, individual, versatile!

**The TAURUS® series 1-4 with remote mounted pressure transducer in axial version – making it more flexible, versatile and ergonomic**

## TAUREX 1-4 AXIAL

### TECHNICAL DATA

Operating air pressure:	5 to 7 bar
Air hose connection:	6 mm (1/4")
Noise emission:	max. 79 dB
Vibrations:	< 2.9 m/s <sup>2</sup>
Weight:	
TAUREX 1 Axial	2.4 kg
TAUREX 2 Axial	2.7 kg
TAUREX 3 Axial	3.0 kg
TAUREX 4 Axial	3.1 kg

### APPLICATIONS

The TAUREX Axial is a particular advantage in restricted spaces due to the separate pressure transducer mounted in the working direction. The special pistols of TAUREX Axial offer the option of installation in production systems and simultaneously allow flexible and handheld ergonomic work in applications with restricted accessibility that require a vertical, downwards oriented riveting action.

In order to ensure that no gap is left between the components to be riveted and the setting head effectively makes contact with the application, the TAUREX Axial can be additionally supplied with a spring-loaded trigger system.

**It is essential to use an external suction system with the TAUREX Axial!**

A compressed air supply is additionally required for reliable mandrel evacuation. Depending on the application, this is preferably achieved via the balancer with valve or the time delay valve (see page 130).

### WORKING RANGE

- Sets blind rivets up to 6.4 mm Ø all materials and up to 8 mm Ø alu (max. mandrel dia 4.5 mm)
- Same performance and technical data as the respective TAURUS® series 1-4
- 3 metre hose length between pressure transducer and setting pistol



### ADVANTAGES

- Also perfectly designed for fixed installation in production lines or semi-automatic workstations
- Very practical for processing blind rivets in positions that require a vertical rivet setting process
- Low weight of the hand held tool
- Tubing connection with quick-connect feature (upon request) on the pressure transducer side: No oil leak and no air bleeding
- The tool can be equipped with almost all TAURUS® series options: e.g. extension units, blind rivet counter, spring loaded trigger system and remote control
- The handle in the rivet axle allows ergonomic work – especially in vertical applications
- Can be suspended on a balancer

TOOL	No.
TAUREX 1 Axial	<b>145 8026</b>
TAUREX 2 Axial	<b>145 8032</b>
TAUREX 3 Axial	<b>145 8047</b>
TAUREX 4 Axial	<b>145 1019</b>
TAUREX 1 Axial with spring-loaded trigger system	<b>145 1002</b>
TAUREX 2 Axial with spring-loaded trigger system	<b>145 8033</b>
TAUREX 3 Axial with spring-loaded trigger system	<b>145 1016</b>
TAUREX 4 Axial with spring-loaded trigger system	<b>145 1020</b>

**TAURUS® versions** – Safe, individual, versatile!

The **TAURUS® series 1-4** with an axial pressure transducer mounted directly on the device – for use in tight working spaces

## TAUREX 1-4 AXIAL COMPACT

### TECHNICAL DATA

Operating pressure:	5 to 7 bar
Air hose connection:	6 mm (1/4")
Noise emission:	max. 79 dB
Vibrations:	< 2.9 m/s <sup>2</sup>
Weight:	
TAUREX 1 Axial compact	3.1 kg
TAUREX 2 Axial compact	3.4 kg
TAUREX 3 Axial compact	3.7 kg
TAUREX 4 Axial compact	4.1 kg

### APPLICATIONS

The TAUREX Axial compact is a particular advantage in enclosed spaces due to the pressure transducer mounted close and parallel to the tool's axis. The special pistols of TAUREX Axial compact offer the option of installation in production systems and simultaneously allow flexible and handheld ergonomic work in applications with restricted accessibility that require a vertical, downwards oriented riveting action. In order to ensure that no gap is left between the components to be riveted and the setting head effectively makes contact with the application, the TAUREX Axial compact can be additionally supplied with a spring-loaded trigger system (see page 130).

### WORKING RANGE

Processing blind rivets up to 6.4 Ø all materials and up to 8 mm Ø alu (max. mandrel dia. 4.5 mm)  
Same performance and technical data as the respective individual units in the TAURUS® series 1-4



### ADVANTAGES

- Pressure transducer attached in a space-saving manner directly to the device, i.e. also for applications in tight spaces
- Technical design close to the TAUREX Axial
- Also perfectly designed for fixed installation in production lines or semi-automatic workstations
- Very practical for processing blind rivets in positions that require a vertical rivet setting process
- The tool can be equipped with almost all TAURUS® series options: e.g. extension units, blind rivet counter, springloaded trigger system and remote control
- The handle in the rivet axis allows ergonomic work – especially in vertical applications.
- Can be suspended on a balancer

TOOL	No.
TAUREX 1 Axial compact	<b>145 1003</b>
TAUREX 2 Axial compact	<b>145 8034</b>
TAUREX 3 Axial compact	<b>145 8048</b>
TAUREX 4 Axial compact	<b>145 8059</b>
TAUREX 1 Axial compact with spring-loaded trigger system	<b>145 8027</b>
TAUREX 2 Axial compact with spring-loaded trigger system	<b>145 8035</b>
TAUREX 3 Axial compact with spring-loaded trigger system	<b>145 8049</b>
TAUREX 4 Axial compact with spring-loaded trigger system	<b>145 1022</b>



**TAURUS® versions** – Safe, individual, versatile!

## **TAURUS® 1-4 WITH SPRING-LOADED TRIGGER SYSTEM**

The spring-loaded trigger system ensures that the components which are to be riveted are reliably placed one on top of the other gapfree prior to the riveting process.

Furthermore, this ensures that the blind rivet reaches its end position in the bore prior to the setting process and that the setting head is in the right position.

The pressure force can be variably applied depending on the application.

The spring-loaded trigger system cannot be retrofitted but is supplied completely attached.



**TAURUS® 1** with spring-loaded trigger system  
**No. 145 7680**

**TAURUS® 2** with spring-loaded trigger system  
**No. 145 7778**

**TAURUS® 3** with spring-loaded trigger system  
**No. 143 5869**

**TAURUS® 4** with spring-loaded trigger system  
**No. 145 7965**

### **New feature:**

Adjustable range from 15 to 75 N /  
Guaranteed easy-to-apply contact /  
force by use of springs

3

## **TAURUS® 1-4 WITH PH2000 SPENT MANDREL CONTAINER**

The fixed mounted, large PH 2000 mandrel container is very sturdy and particularly suited to long mandrels from 50 to 70 mm in length. The container fits all TAURUS® versions 1 to 4.



**TAURUS® 1** with PH 2000 spent mandrel container  
**No. 145 7669**

**TAURUS® 2** with PH 2000 spent mandrel container  
**No. 145 7780**

**TAURUS® 3** with PH 2000 spent mandrel container  
**No. 145 7878**

**TAURUS® 4** with PH 2000 spent mandrel container  
**No. 145 7970**



**107**

You will find the corresponding conversion kits on **page 107**

## **TAURUS® TOOLS FOR STATIONARY USE IN PRODUCTION SYSTEMS**

The TAURUS® tools can be integrated as stationary units in automatic production systems and operated by remote control, if required. As an option, a low-pressure connection can be used to detect the blind rivet in the nosepiece.

If required, the spent mandrel can be disposed of by means of an evacuation tube and also monitored by a sensor. In stationary production systems, several tools can be operated automatically and in parallel in order to achieve the highest possible level of efficiency.

# PH 2

## Hydro-pneumatic blind rivet setting tool

No. 145 6771



### TECHNICAL DATA

Weight:	1.3 kg
Operating air pressure:	5 - 7 bar
Air hose connection:	6 mm Ø (1/4")
Air consumption:	1.2 - 1.8 ltr. per rivet (0.3 ltr. compr. air)
Traction power:	8,800 N at 6 bar
Stroke:	15 mm

### WORKING RANGE

Blind rivets from 3 up to 5 mm Ø all materials and blind rivets with 2.4 mm up to 3.2mm Ø with small jaws (page 155). **Not suitable for stainless steel CAP® blind rivets.**

### SCOPE OF DELIVERY

Nosepieces: 16/24, 16/27, 16/29, 16/32 and 16/36  
1 set of jaws, 1 spent mandrel bottle,  
1 wrench each of MSU and MSZ,  
Maintenance instructions with spare parts list

### JAWS (3 PARTS)

for PH 2 and PH 2000

No. 143 4103

### ADVANTAGES

- Hydraulic head made of aluminium with wear-proof cylinder surface
- Pneumatic cylinder made of die cast aluminium
- Pistons: Steel hardened and chrome-plated – smooth operation and wear-proof
- Compact seals are wear-proof for a long service life
- Fast venting valve for fast return and high working sequence
- Low-noise pneumatic switching
- Simple, low-interruption valve design
- Hydraulic head can be adjusted by 360°
- Favourable centre of gravity and handle design for fatigue-free handling

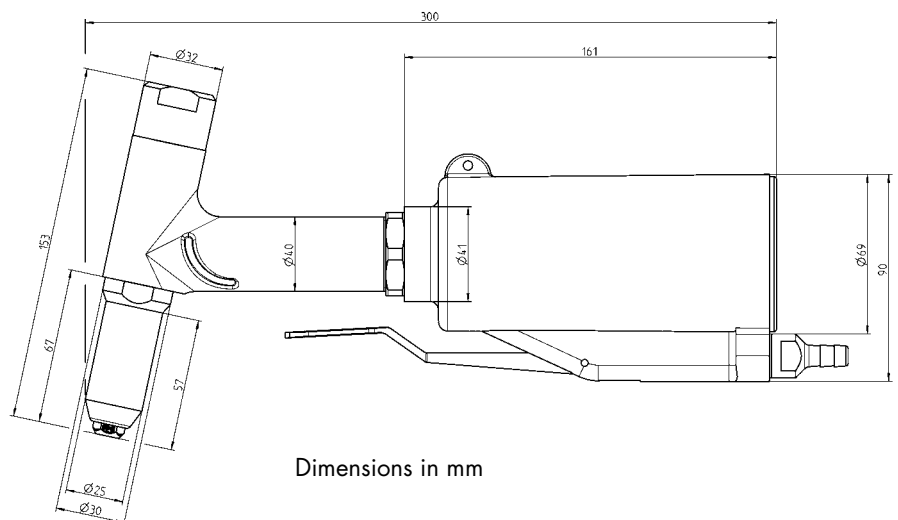

# PH 2-VK

Hydro-pneumatic blind rivet setting tool

No. 145 6774

## TECHNICAL DATA

Weight:	1.3 kg
Operating air pressure:	5 - 7 bar
Air hose connection:	6 mm Ø (1/4")
Air consumption:	1.2-1.8 ltr. per rivet (0.3 ltr. compr. air)
Traction power:	6,200 N at 6 bar
Stroke:	14 mm

## WORKING RANGE

Blind rivets up to 4 mm Ø alu, steel and copper

## SCOPE OF DELIVERY

Nosepieces: 10/18, 10/24 and 10/27  
1 spent mandrel bottle,  
1 maintenance wrench of MSU and MSZ,  
maintenance instructions with spare parts list

## JAWS (2 PARTS)

for PH 2-VK

No. 143 4071



**VK:** Shorter version of the pistol head for difficult to access rivets

## ADVANTAGES

- Due to the shortened gun head, the PH2-VK is ideal for difficult-to-access areas/riveting points

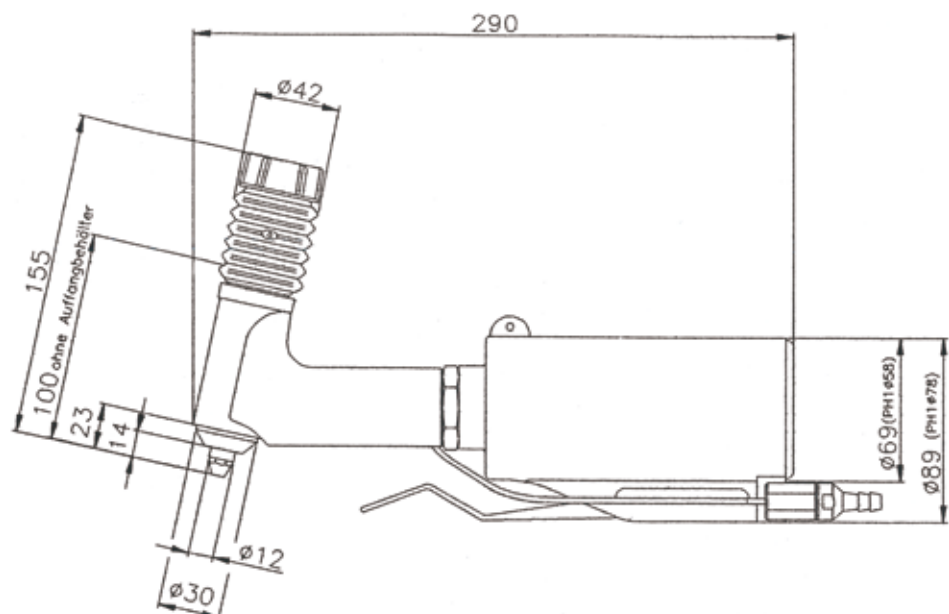

Dimensions in mm

# PH AXIAL

## Hydro-pneumatic blind rivet setting tool

### No. 145 8063

#### TECHNICAL DATA

Weight:	1.8 kg
Operating air pressure:	5 - 7 bar
Air hose connection:	6 mm Ø (1/4")
Air consumption:	1.2-1.8 ltr. per rivet (0.3 ltr. compr. air)
Traction power:	8,800 N at 6 bar
Stroke:	15 mm

#### WORKING RANGE

Blind rivets from 4 up to 5 mm Ø steel and 2.4 up to 3.2 mm Ø with small jaw assembly (page 132).

#### SCOPE OF DELIVERY

Nosepieces: 16/24, 16/27, 16/29 and 16/32  
Jaw pusher with reducing tube no.125 for 4 mm Ø blind rivets in alu and copper  
Ejection tube with socket for spent mandrels  
Maintenance instructions and spare parts list

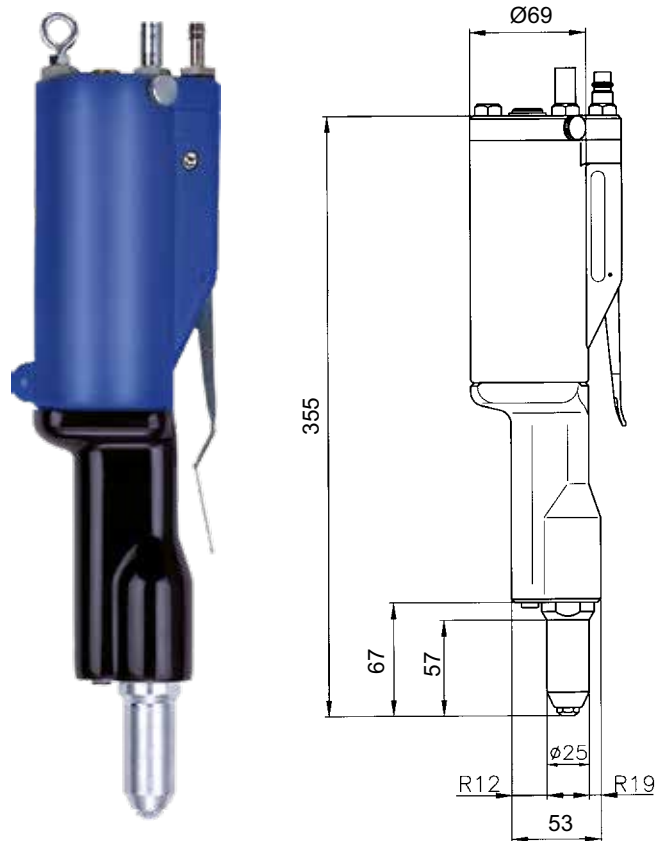

Dimensions in mm

**JAWS (3 PARTS)** for PH Axial

### No. 143 4103

#### ADVANTAGES

- Pneumatic cylinder and hydraulic head with jaw mechanism arranged axially behind each other: simple and easy handling when used vertically (e.g. desktop assembly points)
- Integrated blind rivet suction and rivet mandrel ejection system: does not need to be retrofitted, secure disposal of the spent mandrels in a central container via a hose
- Hydraulic head in aluminium with wear-proof cylinder surface
- Pneumatic cylinder made of die cast aluminium
- Working piston made of hardened and hard chromium plated steel make the device easy to handle and wear-proof
- Compact seals are wear-proof with large scraper effect, long service life
- Fast venting system: faster return; high work sequence
- Low-noise pneumatic switching
- Simple valve structure: interruption free

# SPECIAL ACCESSORIES TAURUS®/TAUREX versions/PH tools

## HEAD MODULES FOR TAURUS® 5-6 AND TAUREX 5-6

### Adaption takes priority

The TAURUS® 5 and 6 riveting tools must be adapted to the different kinds of rivets and lockbolts through specific pulling head modules



**!** The suitability of nosepiece and fastener needs to be tested by the user and is user's own responsibility!



Head module for 7.8 mm Titgemeyer TIBULB\*

**No. 145 8008**

Head module for 9.8 mm Huck Magna-Lok®\*

**No. 145 8009**

\* partly registered trademarks of TITGEMEYER GmbH & Co. KG or Alcoa Fastening Systems

Other head modules on request.

3

## BALANCER AND TIME DELAY VALVE

for all TAURUS® 1-4-Axial- and TAUREX 1-4-Axial tools

To cover various requirements, two balancer models for suspending the TAURUS® Axial tools are available. If the tube for evacuating the spent mandrel can be kept very short, no external mandrel evacuation assistance is necessary which means a balancer without valve is sufficient.

However, if due to the tube length external evacuation assistance of the mandrel becomes necessary it can be switched on and off by means of the valve balancer in order to save cost-intensive compressed air.



Balancer without valve

**No. 143 4734**

## BALANCER WITH DISCONNECTING VALVE

The balancer with disconnecting valve is used when the blind rivet is to be inserted into the tool. In this case the valve interrupts the compressed air necessary to generate negative pressure when in its highest position.



Balancer with disconnecting valve

**No. 145 7733**

# SPECIAL ACCESSORIES TAURUS®/TAUREX versions/PH tools

## TIME DELAY VALVE

The time delay valve on the other hand is used when the blind rivet is to be inserted into the part. During the rivet setting procedure, the valve activates the compressed air required to create a vacuum and shuts it off after a set time.



Time delay valve  
**No. 145 0893**

## INTERFACE 4.0 FOR CONNECTION TO EXTERNAL CONTROLLERS

The new communication interface between GESIPA® tools and production



**No. 163 4326**

## SMALL JAW ASSEMBLY FOR PH 2, PH 2000 AND PH-AXIAL

With reduced head diameter (18 mm) and 2 part jaws.

### Working range

up to 4 mm Ø stainless steel and 5 mm Ø alu

### Scope of supply

Standard: nosepiece 10/24 (optional also with nosepiece 10/18, 10/27, 10/29, 10/32)

PH 2  
**No. 145 6783**

PH 2000  
**No. 143 4234**

PH Axial  
**No. 145 8075**

## SPECIAL STEEL SLEEVE AF 20/AF 30 FOR TAURUS®SERIES

With reduced steel sleeve diameter to overcome installation space limitations.

### Working capacity

All materials in all diameters



AF 20: TAURUS® 1-4  
**No. 145 8001**

AF 30: TAURUS® 5-6  
**No. 160 8786**

## MULTI-PIECE EXTENSION UNITS

For riveted joints in low-lying places. Screwed in between the device and the existing steel case

**Total length = steel head sleeve + extension + standard nosepiece**

### PH tools

The total length of the steel head sleeve, including the extension unit, is 157 mm for 100 mm.



TOOL	100 mm
PH 2	145 6779

## UNIVERSAL NOSEPIECE - 16

for blind rivet tools HN 2, PH 2, PH 2000

The universal nosepiece replaces five nosepiece sizes. The integrated rotary star in the steel sleeve can be unlocked easily without tools in order to select the appropriate size of nosepiece.

### WORKING RANGE

Blind rivets from 2.4 up to 5 mm Ø alu, copper and steel and up to 4 mm Ø stainless steel.

### OPERATION

Operate the tool and hold trigger, then push back adjusting ring to end position (1).  
By turning the rotary star (2).



**No. 145 6776**

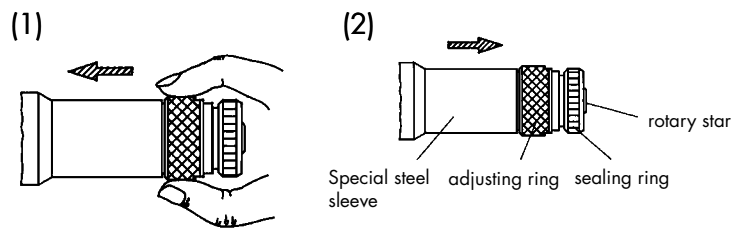

The universal nosepiece includes: Special steel sleeve, complete adjusting ring, rotary star and sealing ring.

## VAS

Vacuum absorption system for PH2

**No. 145 7579**

This device absorbs the spent mandrel after the riveting operation and transports it automatically into the mandrel container. A further advantage is offered when the rivet, inserted into the nosepiece, is held in the jaw mechanism even if the tool head is in the vertical downwards position. The vacuum absorption device is available as a complete built-in and can also be retrofitted to existing GESIPA® riveting power tools at any time.

### TECHNICAL DATA

Weight of kit: 430 g  
Operating air pressure: 4-6 bar

### SCOPE OF DELIVERY

1 air deflector  
1 wrench MSU  
Maintenance instructions with spare parts list

## OFFSET HEAD FOR PH2

For setting rivets in places with difficult access and in corners



**Offset head for PH2** with 3 part jaws  
**No. 145 6612**

# SPECIAL ACCESSORIES / NOSEPIECES Blind rivet setting tools

## NOSEPIECES STANDARD + SPECIAL LENGTH

NTS, NTX, NTX-F, Flipper®, SN 1, PH 1, PH 2-VK

Ø	Material	Ø d	Ø D	Standard	No.	V (9mm)	No.
2.4	Alu	1.6	6.0	10/16	<b>143 4054</b>		
2.4	Alu	1.8	6.0	10/18	<b>143 4055</b>	V-10/18	<b>143 4096</b>
3.2	CAP®-Alu, CAP®-Copper	1.8	6.0	10/18	<b>143 4055</b>	V-10/18	<b>143 4096</b>
3 and 3.2	Alu, Cu, Steel, Stainless steel, Stinox, Alu/Alu, PG-Alu, PG-Steel	2.4	6.0	10/24	<b>143 4061</b>	V-10/24	<b>143 4097</b>
4	Alu, Cu	2.4	6.0	10/24	<b>143 4061</b>	V-10/24	<b>143 4097</b>
4	Steel, CAP®-Alu, CAP®-Cu, Alu/Alu, PG-Alu	2.7	6.0	10/27	<b>143 4062</b>	V-10/27	<b>143 4098</b>
4	Stainless steel, Stinox, PG-Steel	2.9	8.0	10/29	<b>143 4064</b>	V-10/29	<b>143 4099</b>
4.8	CAP®-Alu, CAP®-Cu	2.9	8.0	10/29	<b>143 4064</b>	V-10/29	<b>143 4099</b>
4.8 and 5	Alu, PG-Alu	3.2	8.0	10/32	<b>143 4065</b>	V-10/32	<b>143 4100</b>
4	Plastic	3.0	-	10/30 K	<b>143 4092</b>	-	-
5	Plastic	3.5	-	10/35 K	<b>143 4093</b>	-	-
6	Plastic	4.0	-	10/40 K	<b>143 4094</b>	-	-

Standard version  
10/..... Nosepieces

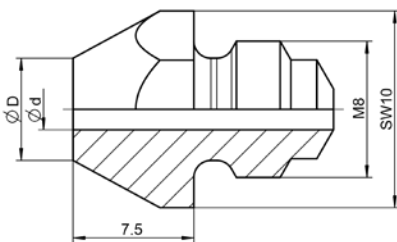

Extended version (9mm)  
V-10/.....Nosepieces

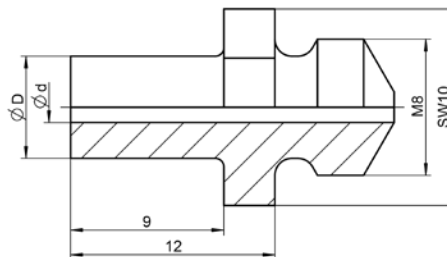

The name of the nosepiece (e.g. 17/32) can be found directly on the nosepiece.



## NOSEPIECES STANDARD

Flipper® Plus

Ø	Material	Ø d	Ø D	Standard	No.
2.4	Alu	2.0	6.0	12/20	<b>157 2920</b>
3.2	CAP®-Alu, CAP®-Cu	2.0	6.0	12/20	<b>157 2920</b>
3 and 3.2	Alu, Cu, Steel, Stainless steel, Stinox, Alu, PG-Alu, PG-Steel	2.4	6.0	12/24	<b>157 2924</b>
4	Alu, Cu	2.4	6.0	12/24	<b>157 2924</b>
4	Steel, CAP®-Alu, CAP®-Cu, Alu,	2.4	6.0	12/24	<b>157 2924</b>
4	Stainless steel, Stinox, PG-Steel	2.9	8.0	12/29	<b>157 2925</b>
4.8	CAP®-Alu, CAP®-Cu	2.9	8.0	12/29	<b>157 2925</b>
4.8 and 5	Alu, PG-Alu	3.2	8.0	12/32	<b>161 8800</b>
4.8 and 5	Steel, Alu	3.2	8.0	12/32	<b>161 8800</b>

Standard version  
12/..... Nosepieces

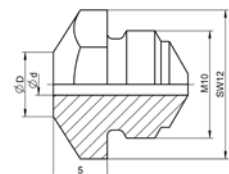

Standard version BRN  
12/M..... Nosepieces

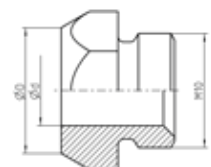

### BLIND RIVET NUTS

M4	Alu, Steel	4.15	11.0	12/M4	<b>157 2926</b>
M5	Alu, Steel, PG-Alu, PG-Steel	5.15	11.0	12/M5	<b>157 2927</b>
M6	Alu, PG-Alu	6.15	11.0	12/M6	<b>157 2929</b>





**NOSEPIECES STANDARD + SPECIAL LENGTH HN 2, PH 1, PH 2, PH 2-VK, PH Axial, PH 2000**

Ø	Material	Ø d	Ø D	Standard	No.	V (10 mm)	No.
2.4	Alu	1.8	6.0	16/18	143 4285	V-16/18	143 4370
3.2	CAP®-Alu, CAP® Copper	1.8	6.0	16/18	143 4285	V-16/18	143 4370
3	Alu/Cu	2.0	6.0	16/20	143 4287	V-16/20	143 4371
3 and 3.2	Alu, Cu, Steel, Stainless steel, Stinox, Alu/Alu, PG-Alu, PG-Steel	2.4	6.0	16/24	143 4288	V-16/24	143 4372
4	Alu, Cu, CAP®-Alu, CAP®-Cu	2.4	6.0	16/24	143 4288	V-16/24	143 4372
4	Steel, Alu/Alu, PG-Alu	2.7	8.0	16/27	143 4289	V-16/27	143 4373
4	Stainless steel, Stinox, PG-Steel	3.0	8.0	16/29	143 4290	V-16/29	143 4374
4.8 and 5	Alu, CAP®-Alu, CAP®-Cu, PG-Alu	3.0	8.0	16/29	143 4290	V-16/29	143 4374
4.8 and 5	Steel, Alu/Alu	3.35	8.0	16/32	143 4291	V-16/32	143 4375
4.8 and 5	Stainless steel, Stinox, PG-Steel	3.6	10.0	16/36	143 4292	V-16/36	143 4376
6	Alu	3.6	10.0	16/36	143 4292	V-16/36	143 4376
6	Steel	4.0	10.0	16/40	143 4293	V-16/40	143 4369
6.4	Alu, PG-Alu	4.0	10.0	16/40	143 4293	V-16/40	143 4369
6.4	Steel, Alu/Alu	4.5	10.0	16/45	143 4300	V-16/45	143 4378
4	Plastic	3.0	-	16/30 K	143 4130		
5	Plastic	3.5	-	16/35 K	143 4131		
6	Plastic	4.0	-	16/40 K	143 4132		

Standard version  
16/..... Nosepieces

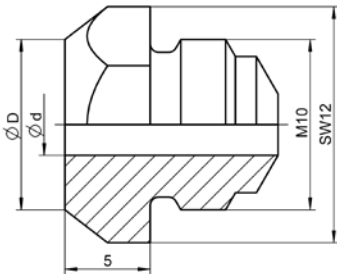

Extended version (10 mm)  
V-16/..... Nosepieces

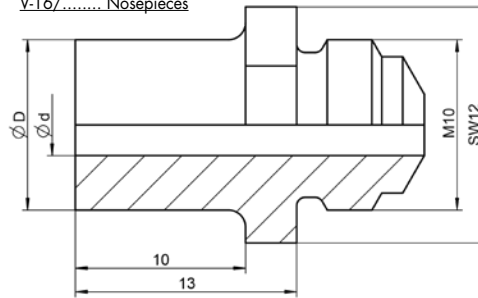

**MEGA GRIP® / Monobolt®**

Ø	Material	Ø d	Ø D	Designation	No.
4.8	all MEGA GRIP®	3.1	8.0	16/31 MG	143 4380
6.4	all MEGA GRIP®	4.2	10.0	16/41 MG	143 4381
4.8	Monobolt®	3.15	7.7	16/31 MB	143 4379
6.4	Monobolt®	4.2	9.5	16/42 MB	143 4163

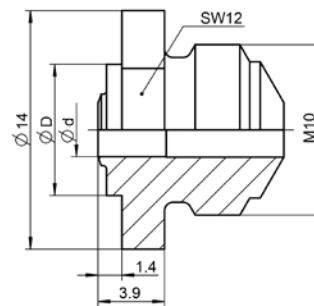

**BULB-TITE®**

Ø	Material	Ø d	Ø D	Designation	No.
4	all BULB-TITE®	2.64	8.0	16/26 BT	143 4301
5.2	all BULB-TITE®	3.23	10.0	16/32 BT	143 4302
6.3	all BULB-TITE®	4.2	11.0	16/42 BT	143 4303
7.7	all BULB-TITE®	4.8	10.0	16/48 BT	143 4304

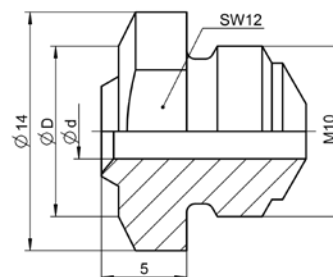

**!** The suitability of nosepiece and fastener needs to be tested by the user and is user's own responsibility!

# SPECIAL ACCESSORIES / NOSEPIECES Blind rivet setting tools

## NOSEPIECES STANDARD + SPECIAL LENGTH

SN2, AccuBird®, AccuBird® Pro, PowerBird®, PowerBird® Pro, PowerBird® Pro Gold Edition, TAURUS®

Ø	Material	Ø d	Ø D	Standard	No.	V (8mm)	No.
2.4	Alu	1.6	6.0	17/16	<b>143 4972</b>	-	-
2.4	Alu	1.8	6.0	17/18	<b>143 4976</b>	V-17/18	<b>143 4979</b>
3.2	CAP®-Alu, CAP® Copper	1.8	6.0	17/18	<b>143 4976</b>	V-17/18	<b>143 4979</b>
3	Alu/Cu	2.0	6.0	17/20	<b>143 4994</b>	V-17/20	<b>145 7315</b>
3	Alu, Cu, Steel, Stainless steel, Stinox, Alu/Alu	2.2	6.0	17/22	<b>143 5018</b>	V-17/22	<b>145 7323</b>
3 and 3.2	Alu, Cu, Steel, Stainless steel, Stinox, Alu/Alu, PG-Alu, PG-Stahl	2.4	6.0	17/24	<b>143 4955</b>	V-17/24	<b>143 4980</b>
4	Alu, Cu, CAP®-Alu, CAP®-Cu	2.4	6.0	17/24	<b>143 4955</b>	V-17/24	<b>143 4980</b>
4	Steel, Alu/Alu, PG-Alu	2.7	8.0	17/27	<b>143 4973</b>	V-17/27	<b>143 4981</b>
4	Stainless steel, Stinox, PG-Steel	3.0	8.0	17/29	<b>143 4974</b>	V-17/29	<b>143 4982</b>
4.8 and 5	Alu, CAP®-Alu, CAP®-Cu, PG-Alu	3.0	8.0	17/29	<b>143 4974</b>	V-17/29	<b>143 4982</b>
4.8 and 5	Steel, Alu/Alu	3.35	8.0	17/32	<b>143 4975</b>	V-17/32	<b>143 4983</b>
4.8 and 5	Stainless steel, Stinox, PG-Steel	3.6	10.0	17/36	<b>143 4977</b>	V-17/36	<b>143 4984</b>
6	Alu	3.6	10.0	17/36	<b>143 4977</b>	V-17/36	<b>143 4984</b>
6	Steel	4.0	10.0	17/40	<b>143 4999</b>	V-17/40	<b>143 5038</b>
6.4	Alu, PG-Alu	4.0	10.0	17/40	<b>143 4999</b>	V-17/40	<b>143 5038</b>
6.4	Steel, Alu/Alu	4.5	10.0	17/45	<b>143 4860</b>	V-17/45	<b>143 4866</b>
4	Plastic	3.0	-	17/30 K	<b>143 4933</b>	-	-
5	Plastic	3.5	-	17/35 K	<b>143 5824</b>	-	-
6	Plastic	4.0	-	17/40 K	<b>143 4998</b>	-	-

## MEGA GRIP® / Monobolt®

4.8	all MEGA GRIP®	3.1	8.0	17/31 MG	<b>143 4993</b>
6.4	all MEGA GRIP®	4.2	10.0	17/41 MG	<b>143 4865</b>
4.8	Monobolt®	3.1	8.0	17/31 MB	<b>143 4868</b>
6.4	Monobolt®	4.2	9.5	17/42 MB	<b>143 4869</b>

## BULB-TITE®

4	all BULB-TITE®	2.64	8.0	17/26 BT	<b>143 4985</b>
5.2	all BULB-TITE®	3.23	10.0	17/32 BT	<b>143 4986</b>
6.3	all BULB-TITE®	4.2	11.0	17/42 BT	<b>143 4988</b>
7.7	all BULB-TITE®	4.8	10.0	17/48 BT	<b>143 4989</b>

The name of the nosepiece (e.g. 17/32) can be found directly on the nosepiece.



Standard version  
17/.....Nosepieces

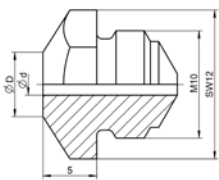

Extended version (8 mm)  
V-17/.....Nosepieces

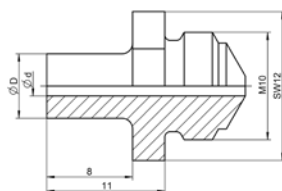

Special version  
17/.....MG Nosepieces

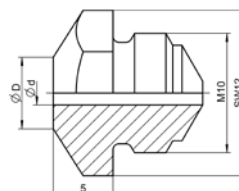

Special version  
17/.....MB Nosepieces

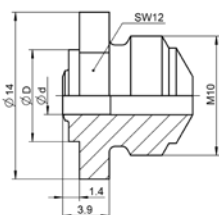

Special version  
17/.....BT Nosepieces

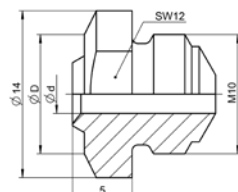

Special version  
17/.....Plastic Nosepieces

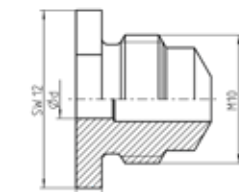

The suitability of nosepiece and fastener needs to be tested by the user and is user's own responsibility!

## RETAINING NOSEPIECES

for SN 2, AccuBird®, AccuBird® Pro, PowerBird®, PowerBird® Pro, PowerBird® Pro Gold Edition

Ø	Material	Ø d	Designation	No.
2.4	Alu	1.85	17/18 R	<b>165 5422</b>
3.2	CAP®-Alu, CAP® Copper	1.85	17/18 R	<b>165 5422</b>
3	Alu/Cu Alu, Cu, Steel, Stainless steel, Stinox, Alu/Alu	2.0	17/20 R	<b>165 5424</b>
3	Alu, Cu, Steel, Stainless steel, Stinox	2.2	17/22 R	<b>165 5426</b>
3 and 3.2	Alu, Cu, Steel, Stainless steel, Stinox, Alu/Alu, PG-Alu, PG-Steel	2.4	17/24 R	<b>165 5427</b>
4	Alu, Cu, CAP®-Alu, CAP®-Cu	2.4	17/24 R	<b>165 5427</b>
4	Steel, Alu/Alu, PG-Alu	2.7	17/27 R	<b>165 5428</b>
4	Stainless steel, Stinox, PG-Steel	2.9	17/29 R	<b>165 5429</b>
4.8 and 5	Alu, CAP®-Alu, CAP®-Cu, PG-Alu	2.9	17/29 R	<b>165 5429</b>
4.8 and 5	Steel, Alu/Alu	3.2	17/32 R	<b>165 5430</b>
4.8 and 5	Stainless steel, Stinox, PG-Steel	3.6	17/36 R	<b>165 5431</b>
6	Alu	3.6	17/36 R	<b>165 5431</b>
6	Steel	4.0	17/40 R*	<b>165 5433</b>
6.4	Alu, PG-Alu	4.0	17/40 R*	<b>165 5433</b>
6.4	Steel, Alu/Alu	4.5	17/45 R*	<b>165 5434</b>

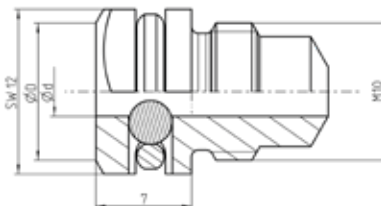

\*Except AccuBird® and AccuBird® Pro

## UNIVERSAL NOSEPIECE

HN2, SN 2, PH 1, PH 2, PH 2000, AccuBird®, PowerBird®

Ø	Material	Ø d	HN 2, SN 2, PH 1, PH 2, PH 2000	Bird® series
2.4	Alu	1.8	<b>No. 145 6776</b>	<b>No. 143 4960</b>
3.2	CAP®-Alu, CAP® Copper	1.8		
3 and 3.2	Alu, Cu, Stahl, Stainless steel, Stinox, Alu/Alu, PG-Alu, PG-Steel	2.4		
4	Alu, Cu, CAP®-Alu, CAP®-Cu	2.4		
4	Steel, Alu/Alu, PG-Alu	2.7		
4	Stainless steel, Stinox, PG-Steel	2.9		
4.8 and 5	Alu, CAP®-Alu, CAP®-Cu, PG-Alu	2.9		
4.8 and 5	Steel, Alu/Alu			

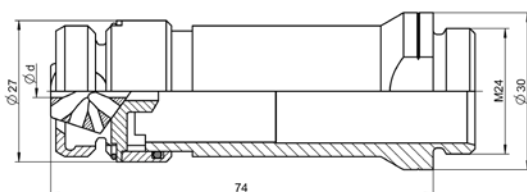

# SPECIAL ACCESSORIES / NOSEPIECES Blind rivet setting tools

## SPECIAL NOSEPIECES

NTS, NTX, NTX-F, Flipper®, PH 1, PH 2-VK

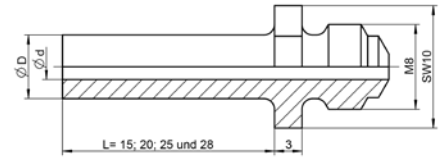

Ø	Material	Ø d	Ø D	Designation	15 mm	20 mm	25 mm	28 mm
3 and 3.2	Alu, Cu, Steel, Stainless steel, Stinox, Alu/Alu, PG-Alu, PG-Steel	2.4	6.5	10/24 SL...	<b>145 6631</b>	<b>145 6630</b>	<b>145 6632</b>	<b>145 6633</b>
4	Alu, Cu	2.4	6.5	10/24 SL...	<b>145 6631</b>	<b>145 6630</b>	<b>145 6632</b>	<b>145 6633</b>
4	Steel, CAP®-Alu, CAP®-Cu, Alu/Alu, PG-Alu	2.7	7.0	10/27 SL...	<b>145 6634</b>	<b>145 6635</b>	<b>145 6636</b>	<b>145 6637</b>
4	Stainless steel, Stinox, PG-Steel	2.9	8.0	10/29 SL...	<b>145 6638</b>	<b>145 6639</b>	<b>146 4001</b>	<b>145 6640</b>
4.8	CAP®-Alu, CAP®-Cu	2.9	8.0	10/29 SL...	<b>145 6638</b>	<b>145 6639</b>	<b>146 4001</b>	<b>145 6640</b>
4.8 and 5	Alu, PG-Alu	3.2	8.0	10/32 SL...	<b>145 6641</b>	<b>145 6642</b>	<b>145 6643</b>	<b>145 6644</b>

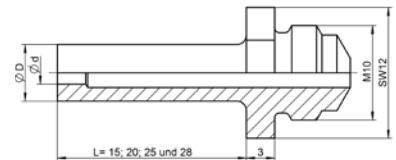

HN 2, PH 1, PH 2, PH 2-VK, PH Axial, PH 2000

Ø	Material	Ø d	Ø D	Designation	15 mm	20 mm	25 mm	28 mm
3 and 3.2	Alu, Cu, Steel, Stainless steel, Stinox, Alu/Alu, PG-Alu, PG-Steel	2.4	6.0	16/24 SL...	<b>145 6812</b>	<b>145 6813</b>	<b>145 6814</b>	<b>145 6815</b>
4	Alu, Cu	2.4	6.0	16/24 SL...	<b>145 6812</b>	<b>145 6813</b>	<b>145 6814</b>	<b>145 6815</b>
4	Steel, PG-Alu	2.7	8.0	16/27 SL...	<b>145 6816</b>	<b>145 6817</b>	<b>145 6818</b>	<b>145 6819</b>
4	Stainless steel, Stinox, PG-Steel	3.0	8.0	16/29 SL...	<b>145 6820</b>	<b>145 6821</b>	<b>145 6822</b>	<b>145 6823</b>
4.8 and 5	Alu, PG-Alu	3.0	8.0	16/29 SL...	<b>145 6820</b>	<b>145 6821</b>	<b>145 6822</b>	<b>145 6823</b>
4.8 and 5	Steel	3.35	8.0	16/32 SL...	<b>145 6824</b>	<b>145 6825</b>	<b>145 6826</b>	-
4.8 and 5	Stainless steel, Stinox, PG-Steel	3.6	10.0	16/36 SL...	<b>145 6828</b>	<b>145 6829</b>	-	<b>145 6830</b>
6	Alu	3.6	10.0	16/36 SL...	<b>145 6828</b>	<b>145 6829</b>	-	<b>145 6830</b>
6.4	Alu, PG-Alu	4.0	10.0	16/40 SL...	<b>145 6807</b>	<b>145 6808</b>	-	-
6.4	Steel, Alu/Alu	4.5	10.0	16/45 SL...	<b>145 6805</b>	<b>145 6806</b>	-	-

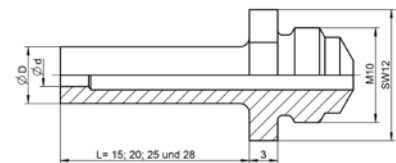

SN2, AccuBird®, AccuBird® Pro, PowerBird®, PowerBird® Pro Gold Edition, TAURUS®

Ø	Material	Ø d	Ø D	Designation	15 mm	20 mm	25 mm	28 mm
2.4	Alu	1.8	6.0	17/18 SL...	<b>145 7367</b>	<b>145 7368</b>	<b>146 4039</b>	<b>146 4040</b>
3.2	CAP®-Alu, CAP® Copper	1.8	6.0	17/18 SL...	<b>145 7367</b>	<b>145 7368</b>	<b>146 4039</b>	<b>146 4040</b>
3	Alu/Cu	2.0	6.0	17/20 SL...	<b>145 7314</b>	<b>145 7305</b>	<b>146 4041</b>	<b>145 7369</b>
3	Alu, Cu, Steel, Stainless steel, Stinox, Alu/Alu	2.2	6.0	17/22 SL...	<b>145 7351</b>	-	<b>145 7349</b>	<b>145 0668</b>
3 and 3.2	Alu, Cu, Steel, Stainless steel, Stinox, Alu/Alu, PG-Alu, PG-Steel	2.4	6.0	17/24 SL...	<b>145 7370</b>	<b>145 7371</b>	<b>145 7372</b>	<b>145 7373</b>
4	Alu, Cu	2.4	6.0	17/24 SL...	<b>145 7370</b>	<b>145 7371</b>	<b>145 7372</b>	<b>145 7373</b>
4	Steel, PG-Alu	2.7	8.0	17/27 SL...	<b>145 7374</b>	<b>145 7376</b>	<b>145 7377</b>	<b>143 5035</b>
4	Stainless steel, Stinox, PG-Steel	3.0	8.0	17/29 SL...	<b>145 7378</b>	<b>145 7379</b>	<b>145 7381</b>	<b>145 7382</b>
4.8 and 5	Alu, PG-Alu	3.0	8.0	17/29 SL...	<b>145 7378</b>	<b>145 7379</b>	<b>145 7381</b>	<b>145 7382</b>
4.8 and 5	Steel	3.35	8.0	17/32 SL...	<b>145 7383</b>	<b>145 7385</b>	<b>145 7386</b>	<b>145 7388</b>
4.8 and 5	Stainless steel, Stinox, PG-Steel	3.6	10.0	17/36 SL...	<b>145 7390</b>	<b>145 7392</b>	<b>145 7393</b>	<b>145 7394</b>
6	Alu/Alu	3.6	10.0	17/36 SL...	<b>145 7390</b>	<b>145 7392</b>	<b>145 7393</b>	<b>145 7394</b>
6	Steel	4.0	10.0	17/40 SL...	<b>145 7399</b>	<b>145 7400</b>	<b>145 7401</b>	<b>145 7402</b>
6.4	Alu, Stainless steel, PG-Alu, PG-Steel und G-Bulb	4.5	10.0	17/45 SL...	<b>145 7265</b>	<b>145 0673</b>	<b>145 7404</b>	<b>145 7398</b>

**!** CAUTION!  
Blind rivets must be ordered as a custom-made product with extended mandrel!

## DELIVERY TIMES ON REQUEST!

### PLATE NOSEPIECES P WITHOUT CUT-OUT

for SN2, HN 2, PH 1, PH 2, PH Axial, PH 2000, Bird series, Bird Pro series, TAURUS®

Ø	Material	Ø d	Designation	HN 2, PH 1, PH 2, PH Axial, PH 2000	Designation	TAURUS® Bird series Bird Pro series SN 2
				No.		No.
3 and 3.2	Alu, Cu, Stahl, Stainless steel, Stinox, Alu/Alu, PG-Alu, PG-Steel	2.4	P 16/24	<b>145 6649</b>	P 17/24	<b>145 7335</b>
4	Alu, Cu, CAP®-Alu, CAP®-Cu	2.4	P 16/24	<b>145 6649</b>	P 17/24	<b>145 7335</b>
4	Steel, Alu/Alu, PG-Alu	2.7	P 16/27	<b>145 6650</b>	P 17/27	<b>145 7336</b>
4	Stainless steel, Stinox, PG-Steel	3.0	P 16/29	<b>145 6651</b>	P 17/29	<b>145 7337</b>
4.8 and 5	Alu, CAP®-Alu, CAP®-Cu, PG-Alu	3.0	P 16/29	<b>145 6651</b>	P 17/29	<b>145 7337</b>
4.8 and 5	Steel, Alu/Alu	3.35	P 16/32	<b>145 6657</b>	P 17/32	<b>145 7338</b>
4.8 and 5	Stainless steel, Stinox, PG-Steel	3.6	P 16/36	<b>145 6656</b>	P 17/36	<b>145 7339</b>
6	Alu	3.6	P 16/36	<b>145 6656</b>	P 17/36	<b>145 7339</b>

For countersunk head blind rivets

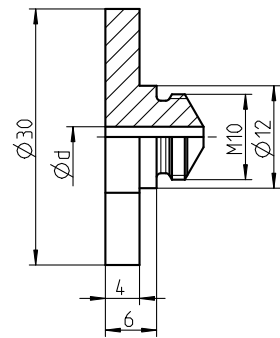

### PLATE NOSEPIECE PA WITH CUT-OUT

for SN2, HN 2, PH 1, PH 2, PH Axial, PH 2000, Bird series, Bird Pro series, TAURUS®

Ø	Material	Ø d	Designation	t	HN 2, PH 1, PH 2, PH Axial, PH 2000	Designation	t	TAURUS® Bird series Bird Pro series SN 2
					No.			No.
3 and 3.2	Alu, Cu, Stahl, Stainless steel, Stinox, Alu/Alu, PG-Alu, PG-Steel	2.4	PA 16/24	1.0	<b>145 6659</b>	PA 17/24	1.0	<b>145 7330</b>
4	Alu, Cu, CAP®-Alu, CAP®-Cu	2.4	PA 16/24	1.0	<b>145 6659</b>	PA 17/24	1.0	<b>145 7330</b>
4	Steel, Alu/Alu, PG-Alu	2.7	PA 16/27	1.0	<b>145 6660</b>	PA 17/27	1.0	<b>145 7331</b>
4	Stainless steel, Stinox, PG-Steel	3.0	PA 16/29	1.1	<b>145 6661</b>	PA 17/29	1.1	<b>145 7341</b>
4.8 and 5	Alu, CAP®-Alu, CAP®-Cu, PG-Alu	3.0	PA 16/29	1.1	<b>145 6661</b>	PA 17/29	1.1	<b>145 7341</b>
5	Al-large flange K 11 and K 14	3.0	PA 16/29 K	1.5	<b>145 6652</b>	PA 17/29 K	1.5	<b>145 7332</b>
4.8 and 5	Steel, Alu/Alu	3.35	PA 16/32	1.1	<b>145 6653</b>	PA 17/32	1.1	<b>145 7333</b>
4.8 and 5	Stainless steel, Stinox, PG-Steel	3.6	PA 16/36	1.1	<b>145 6662</b>	PA 17/36	1.1	<b>145 7342</b>
6	Alu	3.6	PA 16/36	1.3	<b>145 6666</b>	PA 17/36	1.3	<b>145 7334</b>

For standard blind rivets (dome head)

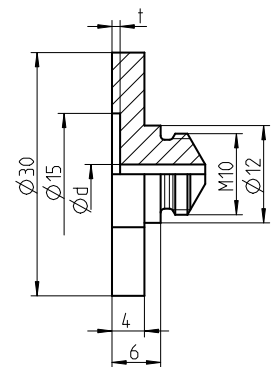

### PIVOT NOSEPIECES PG (for the production of articular rivet connections)

for SN2, HN 2, PH 1, PH 2, PH Axial, PH 2000, Bird series, Bird Pro series, TAURUS®

Ø	Material	Ø d	Designation	t	HN 2, PH 1, PH 2, PH Axial, PH 2000	Designation	t	TAURUS® Bird series Bird Pro series SN 2
					No.			No.
3 and 3.2	Alu, Cu, Steel, Stainless steel, Stinox, Alu/Alu, PG-Alu, PG-Steel	2.4	PG 16/24	1.6	<b>145 6663</b>	PG 17/24	1.6	<b>143 5002</b>
4	Alu, Cu, CAP®-Alu, CAP®-Cu	2.4	PG 16/24	1.6	<b>145 6663</b>	PG 17/24	1.6	<b>143 5002</b>
4	Steel, Alu/Alu, PG-Alu	2.7	PG 16/27	1.6	<b>145 6664</b>	PG 17/27	1.6	<b>143 5003</b>
4	Stainless steel, Stinox, PG-Steel	3.0	PG 16/29	1.6	<b>145 6655</b>	PG 17/29	1.6	<b>143 5007</b>
4.8 and 5	Alu, CAP®-Alu, CAP®-Cu, PG-Alu	3.0	PG 16/29	1.6	<b>145 6655</b>	PG 17/29	1.6	<b>143 5007</b>
5	Al-large flange K 11 and K 14	3.0	PG 16/29 K	2.0	<b>145 6658</b>	PG 17/29 K	2.0	<b>143 5004</b>
5	Al-large flange K 16	3.0	-	-	-	PG 17/29 K16*	2.0	<b>143 5009</b>
4.8 and 5	Steel, Alu/Alu	3.35	PG 16/32	1.6	<b>145 6654</b>	PG 17/32	1.6	<b>143 5005</b>
4.8 and 5	Stainless steel, Stinox, PG-Steel	3.6	PG 16/36	1.6	<b>145 6665</b>	PG 17/36	1.6	<b>143 5006</b>
6	Alu	3.6	PG 16/36	2.0	<b>146 4002</b>	PG 17/36	2.0	<b>145 7340</b>

Pivot nosepiece PG (dimensions compare plate nosepiece „PA“)

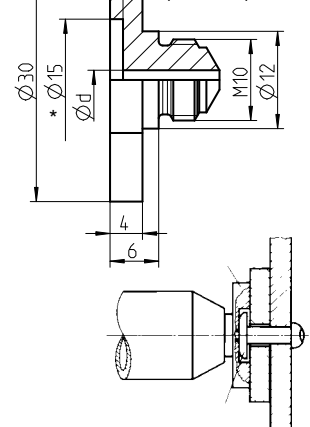

\*Please note:  
For PG 17/29 K16,  
the Ø is 17, not 15.

# SPECIAL ACCESSORIES / NOSEPIECES Blind rivet setting tools with AV\*

\*AV = spring-loaded trigger system

## NOSEPIECES FOR SETTING TOOLS WITH SPRING-LOADED TRIGGER SYSTEM STANDARD + EXTENDED VERSION Bird Pro series and TAURUS®

Ø	Material	Ø d	Ø D	Standard	No.	V (8mm)	No.
2.4	Alu	1.85	6.0	17/18 AV	<b>143 5591</b>	V-17/18 AV	<b>145 7291</b>
3.2	CAP®-Alu, CAP® Copper	1.85	6.0	17/18 AV	<b>143 5591</b>	V-17/18 AV	<b>145 7291</b>
3	Alu/Cu	2.0	6.0	17/20 AV	<b>143 4990</b>	V-17/20 AV	<b>145 0666</b>
3	Alu, Cu, Stahl, Stainless steel, Stinox, Alu/Alu	2.2	6.0	17/22 AV	<b>143 4991</b>	V-17/22 AV	<b>145 0667</b>
3 und 3.2	Alu, Cu, Stahl, Stainless steel, Stinox, Alu/Alu, PG-Alu, PG-Steel	2.4	6.0	17/24 AV	<b>143 5592</b>	V-17/24 AV	<b>145 7292</b>
4	Alu, Cu, CAP®-Alu, CAP®-Cu	2.4	6.0	17/24 AV	<b>143 5592</b>	V-17/24 AV	<b>145 7292</b>
4	Steel, Alu/Alu, PG-Alu	2.7	8.0	17/27 AV	<b>143 5593</b>	V-17/27 AV	<b>145 0628</b>
4	Stainless steel, Stinox, PG-Steel	3.0	8.5	17/29 AV	<b>143 5594</b>	V-17/29 AV	<b>145 0629</b>
4.8 and 5	Alu, CAP®-Alu, CAP®-Cu, PG-Alu	3.0	8.5	17/29 AV	<b>143 5594</b>	V-17/29 AV	<b>145 0629</b>
4.8 and 5	Steel, Alu/Alu	3.35	8.5	17/32 AV	<b>143 5595</b>	V-17/32 AV	<b>145 7725</b>
4.8 and 5	Stainless steel, Stinox, PG-Steel	3.6	10.0	17/36 AV	<b>143 5596</b>	V-17/36 AV	<b>145 0630</b>
6	Alu	3.6	10.0	17/36 AV	<b>143 5596</b>	V-17/36 AV	<b>145 0630</b>
6	Steel	4.0	10.0	17/40 AV	<b>143 5597</b>	V-17/40 AV	<b>145 7293</b>
6.4	Alu, PG-Alu	4.0	10.0	17/40 AV	<b>143 5597</b>	V-17/40 AV	<b>145 7293</b>
6.4	Steel, Alu/Alu	4.5	10.0	17/45 AV	<b>143 5598</b>	V-17/45 AV	<b>145 0631</b>

The name of the nosepiece (e.g. 17/32) can be found directly on the nosepiece.



Standard version  
17/.....Nosepieces

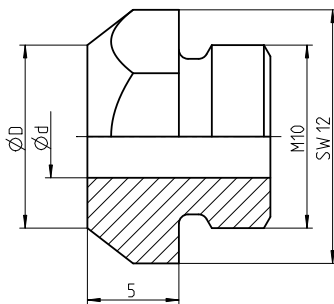

Extended version (8 mm)  
V-17/.....Nosepieces

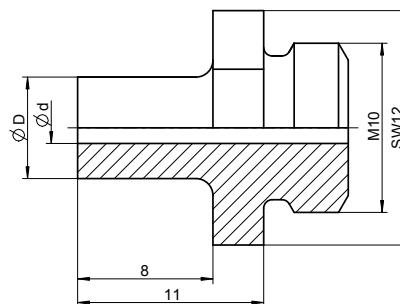

**DELIVERY TIMES ON REQUEST!**

## NOSEPIECES EXTENDED VERSION FOR SETTING TOOLS WITH SPRING-LOADED TRIGGER SYSTEM Bird Pro series and TAURUS®

Ø	Material	Ø d	Ø D	Designation	15 mm	20 mm	25 mm	28 mm
2.4	Alu	1.85	6.0	17/18 AV SL...	<b>145 0634</b>	<b>145 0635</b>	<b>145 0636</b>	<b>145 0637</b>
3.2	CAP®-Alu, CAP® Copper	1.85	6.0	17/18 AV SL...	<b>145 0634</b>	<b>145 0635</b>	<b>145 0636</b>	<b>145 0637</b>
3	Alu/Cu	2.0	6.0	17/20 AV SL...	<b>145 0658</b>	<b>145 0659</b>	<b>145 0660</b>	<b>145 0661</b>
3	Alu, Cu, Steel, Stainless steel, Stinox, Alu/Alu	2.2	6.0	17/22 AV SL...	<b>145 0662</b>	<b>145 0663</b>	<b>145 0664</b>	<b>145 0665</b>
3 and 3.2	Alu, Cu, Steel, Stainless steel, Stinox, Alu/Alu, PG-Alu, PG-Steel	2.4	6.0	17/24 AV SL...	<b>145 0638</b>	<b>145 7321</b>	<b>145 0639</b>	<b>145 0640</b>
4	Alu, Cu	2.4	6.0	17/24 AV SL...	<b>145 0638</b>	<b>145 7321</b>	<b>145 0639</b>	<b>145 0640</b>
4	Steel, PG-Alu	2.7	8.0	17/27 AV SL...	<b>145 0641</b>	<b>145 7322</b>	<b>145 0642</b>	<b>145 7726</b>
4	Stainless steel, Stinox, PG-Steel	3.1	8.0	17/29 AV SL...	<b>145 7324</b>	<b>145 0643</b>	<b>145 7325</b>	<b>145 0644</b>
4.8 and 5	Alu, PG-Alu	3.1	8.0	17/29 AV SL...	<b>145 7324</b>	<b>145 0643</b>	<b>145 7325</b>	<b>145 0644</b>
4.8 and 5	Steel	3.35	8.0	17/32 AV SL...	<b>145 0645</b>	<b>145 7326</b>	<b>145 0646</b>	<b>145 0647</b>
4.8 and 5	Stainless steel, Stinox, PG-Steel	3.6	10.0	17/36 AV SL...	<b>145 0648</b>	<b>145 0649</b>	<b>145 0650</b>	<b>145 0651</b>
6	Alu/Alu	3.6	10.0	17/36 AV SL...	<b>145 0648</b>	<b>145 0649</b>	<b>145 0650</b>	<b>145 0651</b>
6	Steel	4.0	10.0	17/40 AV SL...	<b>145 7327</b>	<b>145 7328</b>	<b>145 0652</b>	<b>145 0653</b>
6.4	Alu, Stainless steel, PG-Alu, PG-Steel and G-Bulb	4.5	10.0	17/45 AV SL...	<b>145 0654</b>	<b>145 0655</b>	<b>145 0656</b>	<b>145 0657</b>

\*AV= spring-loaded trigger system

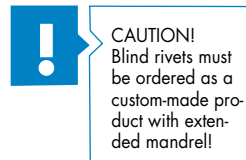
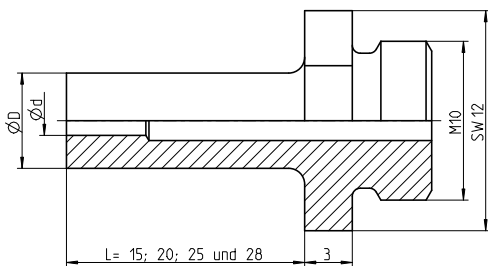

**DELIVERY TIMES ON REQUEST!**



### NOSEPIECE ALLOCATION CARD

You can also use our nosepiece allocation card. This makes it easier to select the correct nosepiece for the respective tools.

**No. 168 9502**

# **GESIPA® AUTOMATIC RIVETING MACHINES**



**GESIPA® automatic riveting machines – fully-automatic, practical, reliable**

**GAV 8000 ECO**  
**GAV 8000 ELECTRONIC**  
**GAV HF**

- All GESIPA® blind rivet machines are perfectly suited for use in industrial large-scale production.
- GAVs can either be operated manually or used as component in a robot-controlled system; integration into a production system is also possible.
- The automatic riveting machines support the setting of a wide range of blind rivets from 2.4 – 6.4 mm in diameter.
- Up to 40 riveting processes per minute can be realized depending of the Type of application.





# THE PRACTICAL MODULAR PRINCIPLE

## THE PRACTICAL MODULAR PRINCIPLE GUARANTEES EFFICIENCY AND QUALITY

### Individual conception for efficiency and flexibility

GESIPA®'s fully-automatic blind rivet processing systems are constructed to meet the customer's special production environment. All factors, such as workplace design, production Type, application, securing of flawless work processes, integration into the sequential organisation and also process documentation for safety-relevant parts, are taken into consideration.

GAV are therefore available with various pistol models, hose length packages, special accessories for various rivet dimensions and production requirements. This results in a large variety of models and a high level of efficiency thanks to the solutions that are adapted to meet requirements. The GAV can be integrated into the system or operated independently. If the application changes, the system can be quickly and easily adapted to the new environment.

3

## GAV – USE IN ROBOT APPLICATIONS

### Use by industry in robot-controlled applications

Both versions of the GAV 8000 can be integrated into robot systems. Industrial robots are used almost everywhere in the production environment. They can be programmed to carry out various movements and can therefore be used highly efficiently in combination with the GESIPA® rivet equipment.

With the controlled, fast and secure production processes it is possible to achieve the following benefits by using a fully-automatic GAV combined with a multi-axle robot:

- **First rate precision**
- **High efficiency**
- **Short cycle times**
- **High flexibility**

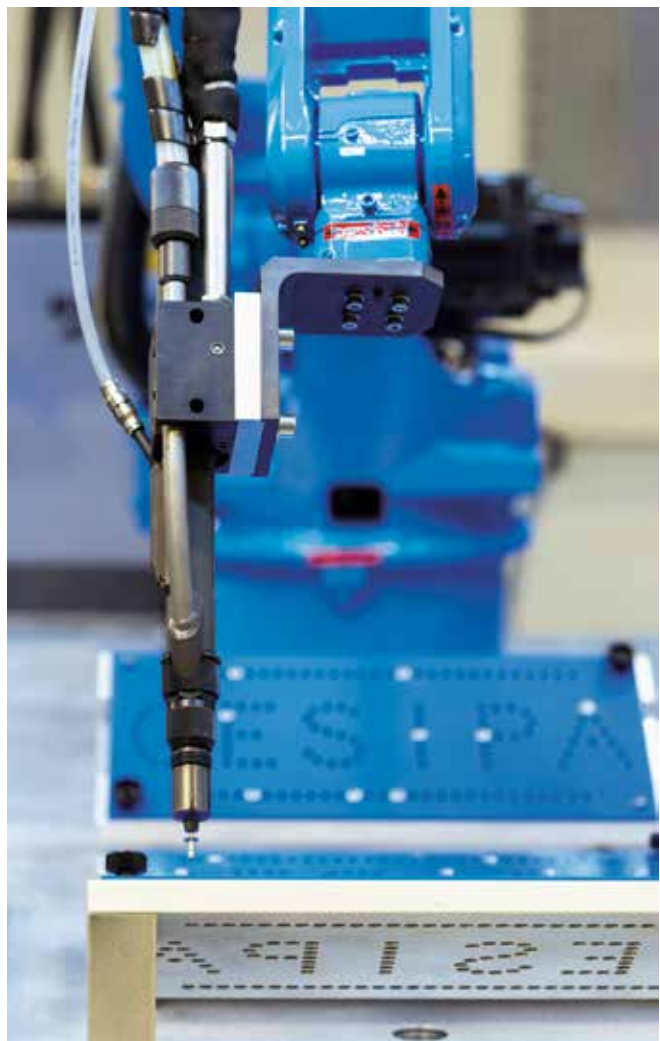

# BLIND RIVET FUNCTION DOCUMENTATION AND SETTING PROCESS MONITORING

**THE INTEGRATED GESIPA® QUALITY MANAGEMENT SYSTEM GUARANTEES PRECISION AND ACCURACY RIGHT FROM THE VERY FIRST PRODUCTION STEP THROUGH TO THE PROCESSED BLIND RIVET.**

The combination of the use of function-documented blind rivets and the use of the setting process monitoring function of the GAV 8000 electronic guarantees process-secure connections.

The quality management system comprises of three areas:

- Dimensional review
- Function test
- Setting process monitoring

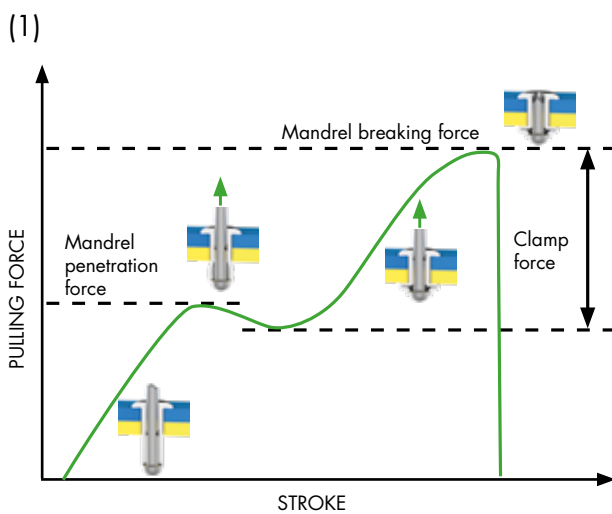

## Function documentation / Setting curve (1)

In addition to other parameters, the setting curve is measured using calibrated testing equipment for every batch of application-specific blind riveting. The measuring results of the shaft deformation, slip-in behaviour, mandrel break load and torque are compared to target values to ensure that the blind rivet in the application is deformed as required and creates a secure connection.

## Monitored process – Reliable connection

100% inspections of the riveting processes are required for safety-relevant applications for industrial processing of blind rivets. In this case, the fully-automatic rivet device GAV 8000 electronic allows application-compatible efficient solutions ranging from the basic system through to a system with a barcode scanner.

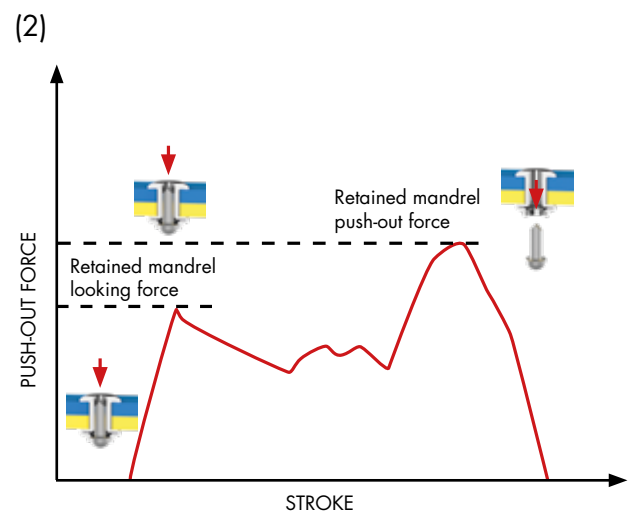

## Function documentation / Mandrel ejection force (2)

The remaining part of the mandrel enclosed in the set rivet is pressed out with the aid of a needle. The measured force can be used to determine whether the remaining part of the pin is properly locked and will not cause any rattling noises or fall out. The batch is only released if both these values are within tolerances.

# THE CONCEPT TO THE INTEGRATED SETTING PROCESS MONITORING



Display of a GAV 8000 electronic indicating the setting curve as part of the setting process monitoring

**THE PROCESS MONITORING SYSTEM IS AN INTEGRAL PART OF THE GAV 8000 ELECTRONIC.**

**It offers the following benefits:**

- Optimum process security thanks to integrated quality concept
- Blind rivet-specific process monitoring
- System can be operated independently
- No memory-programmable control system (SPS) required to operate the device
- No system calibration required when system is exchanged
- Little installation effort required
- Interfaces to the control integration

3

## PROGRAMMING THE SETTING PROCESS MONITORING

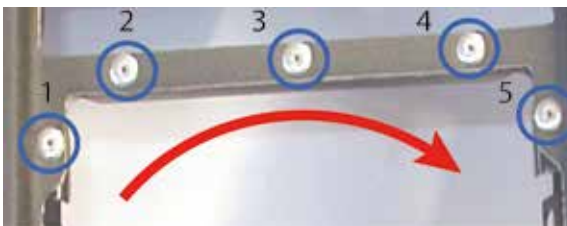

The setting sequence

### **STEP 1:**

#### **Setting up blind rivet position-specific profiles**

Recording and archiving of the relevant process parameters to create a blind rivet connection with reference process curves after defining the analysis window

### **STEP 2:**

#### **Generation of part-specific profile lists**

Summary of the profile in the setting sequence as a control file for the process sequence and process assessment

### **STEP 3:**

#### **Operating the device**

Online analysis and saving of the setting process data with process interruption if deviations are detected

# GESIPA® AUTOMATIC RIVETING MACHINES

## COMPARISON OF GAV 8000 ECO, ELECTRONIC AND GAV HF



PROPERTIES	GAV 8000 eco	GAV 8000 electronic
Range of possible sizes 2.4 mm - 6.4 mm (Alu)	x	x
Up to 40 rivet settings per minute	x	x
Independent system operation possible	x	x
PLC control possible	x	x
Intelligent control – excellent process safety	x	x
Setting of all operating parameters via the display	x	x
Customer-specific software modification	x	x
Maintenance display	x	x
Process monitoring		x
Process parameter memory for up to 9,999 different parts		x
Online transfer of the process data		x
The last 2 million rivet processes are saved in the device		x

## COMPARISON OF GAV 8000 ECO, ELECTRONIC AND GAV HF

On request our technical sales team will send you more information about application possibilities in your company.



	<b>GAV 8000 eco and GAV 8000 electronic</b>	<b>GAV HF</b>
<b>SUPPLY UNIT</b>		
Weight	100 kg	270 kg
Spent mandrel container volume	approx. 1,800 to 5,500 pcs. (3.5 l) depending on size	approx. 1,800 to 5,500 pcs. (3.5 l) depending on size
<b>ELECTRICS</b>		
Nominal voltage	230 Volt ~ 50 Hz	230 Volt ~ 50 Hz
Nominal current	< 2.5 A	< 8 A
Protection class	IP 54	IP 54
<b>PNEUMATICS</b>		
Supply pressure	< 10 bar	< 10 bar
Operating pressure	6 bar	5 bar
Air consumption/riveting	15 NL	30 NL
Air consumption/ spent mandrel extraction	340 NL / min.	340 NL / min.
Connection line	½" (12.5 mm) max. length 5 m	¾" (18.75 mm) max. length 5 m
Rest mandrel extraction tube	Outer Ø 8 mm/ Inner Ø 5 mm	Outer Ø 10 mm/ Inner Ø 6 mm
Pressure transducer	hydro-pneumatic	hydro-pneumatic
<b>RIVET PISTOL</b>		
Weight	ca. 2.5 kg	ca. 7 kg
Stroke	16 - 20 mm	20 mm
Traction power	12,000 N	25,000 N
Standard tube package length	3.75 m (max. 5.0 m)	6 m (max. 25 m)
Working cycle (theoretical)	1.25 sec.	2 Sek.

# GAV 8000 ELECTRONIC / GAV 8000 ECO

**Fully automatic blind rivet system for industrial production with and without setting process monitoring**

Advice and delivery time on request

**integrated setting  
process monitoring**



## WORKING RANGE GAV Electronik

- 2.4 mm up to 6.4 mm Ø alu and copper
- Up to 6 mm Ø steel
- Up to 5 mm Ø stainless steel
- Up to flange diameter 11.4 mm
- Rivet body lengths above 30 mm
- Traction power up to 12,000 N at 6 bar air pressure

## SCOPE OF DELIVERY (both variants)

The scope of delivery always includes one setting pistol.  
This can be freely modified as required.

## SYSTEM DESCRIPTION (both variants)

- Electronic system controls
- Intuitive menu guidance via navigation and function keys
- Function display
- Maintenance display and simple fault diagnosis
- Customer-specific software modification is possible
- Rivet mandrels are disposed of by vacuum system
- Spring loaded trigger system as an optional extra available
- Can be integrated into the system or operated independently
- Interface for external memory programmable control system (SPS) can be realised via the GESIPA® interface



**WITHOUT setting process monitoring** Ideal for applications that do not require any process monitoring



**Subsequent upgrade to GAV 8000 electronic possible in our Walldorf factory at extra price**

Advice and delivery time on request

#### WORKING RANGE GAV eco

- 2.4 mm up to 6.4 mm Ø alu and copper
- Up to 6 mm Ø steel
- Up to 5 mm Ø stainless steel
- Up to flange diameter 11.4 mm
- Rivet body lengths above 30 mm
- Traction power up to 12,000 N at 6 bar air pressure

#### ADVANTAGES (both variants)

##### Productivity and savings potential

- Cost effective from an annual quantity of around 500,000 blind rivets (in relation to the german market)
- Up to 50 % time and costs savings compared to standard blind rivet devices
- Rivet pistol has a large action radius thanks to the hose package that is up to 5.0 m in length (Standard length 3.75 m)
- No trained personnel required for operation
- Can be easily integrated into fully-automatic production systems
- Up to 40 blind rivets can be processed every minute



# PISTOL VERSION for GAV 8000 electronic / GAV 8000 eco

## SPECIFIC WORKSTATION CONFIGURATION

For all GAV versions, three different setting pistol variants are available for the ideal configuration of the workstation. For manual workstations, pistols are available as overhead versions with overhead hose assembly or standard pistols with floor-mounted hose assembly. Both versions are equipped with a balancer to ensure fatigue-free working.

The robotic pistol has been developed exclusively for use in fully automatic production systems or robot-controlled systems. It is supplied from stock with corresponding drilled holes for easy installation. For further questions, please contact our Technical Sales team. A setting pistol suitable for your application is supplied at time of delivery.

## STANDARD PISTOL

Total length: 447 mm (+ SL nose)

The standard pistol is primarily used for **manual operator-controlled** use.

### Advantages

- Can be used for vertical and horizontal riveting
- Inexpensive variant
- On request, it can be fitted with an extra handle to improve ergonomics, in particular for applications involving vertical riveting

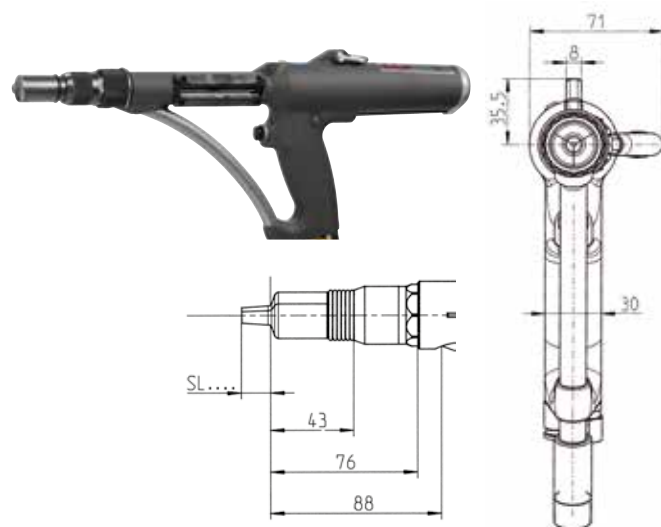

Dimensions in mm

## OVERHEAD PISTOL

Total length: 447 mm (+ SL nose)

The overhead pistol can be used everywhere where the hose package is cumbersome or where it could come into contact with sensitive surfaces.

### Advantage

- Available with contact pressure monitoring

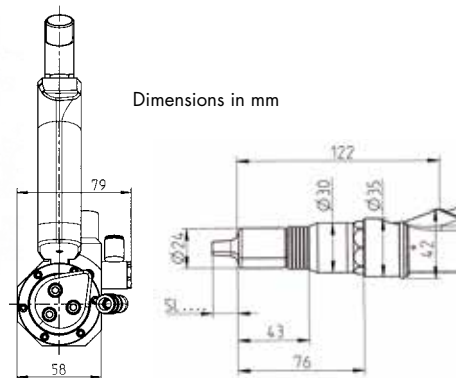

Dimensions in mm

## ROBOTIC PISTOL

Total length: 441 mm (+ SL nose)

The robotic pistol has been developed primarily for use in fully automatic production applications/system (linear units/robots).

### Advantages

- Ideal for integration in a production system
- On request, it can also be fitted with an extra handle (with trigger button) for vertical riveting so that it can be used manually

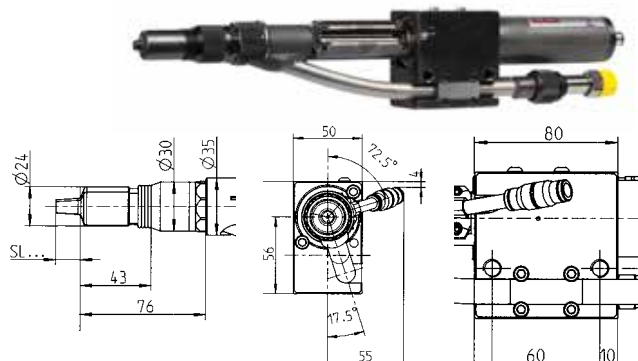

Dimensions in mm



# GAV HF

**Fully-automatic blind rivet system for very strong blind rivets**

## WORKING RANGE

- Blind rivet sizes from 4.8 mm to 6.4 mm  
Ø all materials
- Rivet body lengths up to 35 mm
- Setting head diameter up to 19 mm
- Mandrel up to 5.5 mm Ø
- Traction power up to 25,000 N at 6 bar air pressure



Size comparison between a possible blind rivet of the GAV HF, a GESIPA®-PolyGrip® and an 1 Euro coin.



## ADVANTAGES

- Conveyor pot filling level display
- Operating pressure: 5 bar
- Vibration-dampened pressure intensifier attachment
- Multiple monitoring of the blind rivet pistol by means of sensors
- Industrial control with an 8" colour display
- Conveyor distances of up to 25 m are possible when used in fully-automatic production systems
- Electronic system controls
- Intuitive menu guidance via navigation and function keys
- Function display
- Maintenance display and simple fault diagnosis
- Customer-specific software modification is possible
- Ideal for applications that do not require any process monitoring
- Rivet mandrels are disposed of via a vacuum system
- Surface contact trigger available as an optional extra
- Can be integrated into the system or operated independently
- Interface for external memory-programmable control system (SPS) can be realised via the GESIPA®-Interface

Advice, price and delivery time on request

## **SPECIAL ACCESSORIES** for GAV automatic riveting machines

### **INTERFACE 4.0 – FOR CONNECTION TO EXTERNAL CONTROL**

The new features are:

- 2 x Ethernet interfaces, router functions
- 1 x USB and 1 x USB-OTG
- Screen connection, graphic output via DVI
- Wi-Fi, as access point and as client, Wi-Fi router function
- Local OLED display to show status and error messages
- M.2 SSD interface, the module can be retrofitted with an SSD (large databases)
- PCIe connector for Hilscher netJACK modules (i.e. direct connection to industrial buses such as PROFINET, SERCOS and EtherCAT possible)



**No. 163 4326**

### **ELECTRICAL FOOT PEDAL**

The electrical foot pedal is a good solution wherever applications require both hands to affix the parts that need to be riveted.



### **MAINTENANCE AGREEMENT AND TRAINING**

Ask us about our servicing and maintenance agreements. We can also provide training for your operating, servicing and maintenance personnel when you purchase a GESIPA® blind rivet processing system or at a later date.



### **ONLY FOR GAV 8000** (both variants)

#### **SPECIAL LENGTH TUBE PACKAGES**

A larger working radius can be achieved, e.g. for use on fully automatic production lines, by using packages of special hose lengths. These are available in various dimensions between 3.75 m and 5.0 m to meet the requirements of the various applications.



#### **GAV carriage**

The trolley that has been specially designed for the GAV enables it to be mobile thereby allowing the workplace to be changed quickly and easily.



### GESIPA®-Balancer

For ergonomic and fatigue-free working, it is essential that the pistol and the hose package can be suspended. The Balancer from GESIPA® is the perfect solution.



### ONLY FOR GAV HF

#### SURFACE CONTACT MONITORING WITH DUAL-HAND OPERATION

This special Type of surface contact monitoring guarantees the manipulation-proof process-secure joining of parts. In applications that are relevant for safety, it is often necessary to completely rule out manipulations in the riveting process.



#### GSM RADIO MODUL

In the event of any deviations to the target status e.g. nearly empty feed unit, the GSM radio module (GSM = Global System for Mobile Communications) reports this to a mobile telephone or a process control centre via a call or an SMS. This allows short response times.



#### ELECTRONIC KEY SYSTEM AND SAFETY SWITCH

An electronic key system and a safety switch guarantee safe access control for at least two user groups and lock the covering hood to prevent unauthorised access to the components in the supply unit.



#### SPECIAL LENGTH TUBE PACKAGES

A larger working radius can be achieved, e.g. for use on fully automatic production lines, by using packages of special hose lengths. These are available in various dimensions up to around 25 m to meet the requirements of the various applications.



#### OPERATINGSTATUS DISPLAY

The signal lamps attached to the device in the colours red, green and white indicate the operating status of the system. An empty rivet tank, any deviations from the target operating status etc. are indicated immediately.



# GESIPA® ASSEMBLY CELL

THE NEW GESIPA® ASSEMBLY CELL GUARANTEES OPTIMUM, PRECISE HANDLING WITH A WIDE RANGE OF GESIPA® PROCESSING DEVICES AND A WORKSPACE TAILORED PERFECTLY TO THE CUSTOMER'S REQUIREMENTS.

The desk is adapted individually to customer requirements and designed ergonomically (e.g. adjustable height). Everything – be it the desk, work piece socket, compressed air supply, electrical supply or processing tools – comes from one source, with process monitoring on request.

The optimised work piece socket allows the desk to be converted for different products and processing tools easily, saving costs.

The GESIPA® assembly cell is produced from high quality materials and components. Needless to say, you also have the option of transferring system components already used at your company.

## ADVANTAGES

- Ergonomic working
- Individually adjustable
- Existing work tools can be integrated
- Easy and time-saving conversion for other products from your portfolio
- Setting process monitoring possible

More information on the individually adjusted assembly cell on request. Contact person: Uwe Herth, Head of BU Equipment Manufacturer, [uwe.herth@gesipa.com](mailto:uwe.herth@gesipa.com)



Example:  
Can be individually adjusted for each customer



## Specifics



### Operating status display

The signal light installed on the desk uses different colours to show the process status.



### Counting device

The counting device registers and counts the torn off residual rivet mandrels.



### GESIPA® setting tool

The setting tool is completely integrated in the assembly cell.



### Individual work piece carrier

The optimised work piece carrier allows the desk to be converted for different products and processing tools easily, saving costs.



### Foot pedal

The foot pedal allows you to use both hands to join individual parts and fasten the components to be riveted in place.

# **GESIPA® SPEED RIVET TECHNOLOGY**

**Up to 60 rivets per minute! – Endorsed by major customers! GESIPA® speed rivets are a cost-effective alternative to automation**

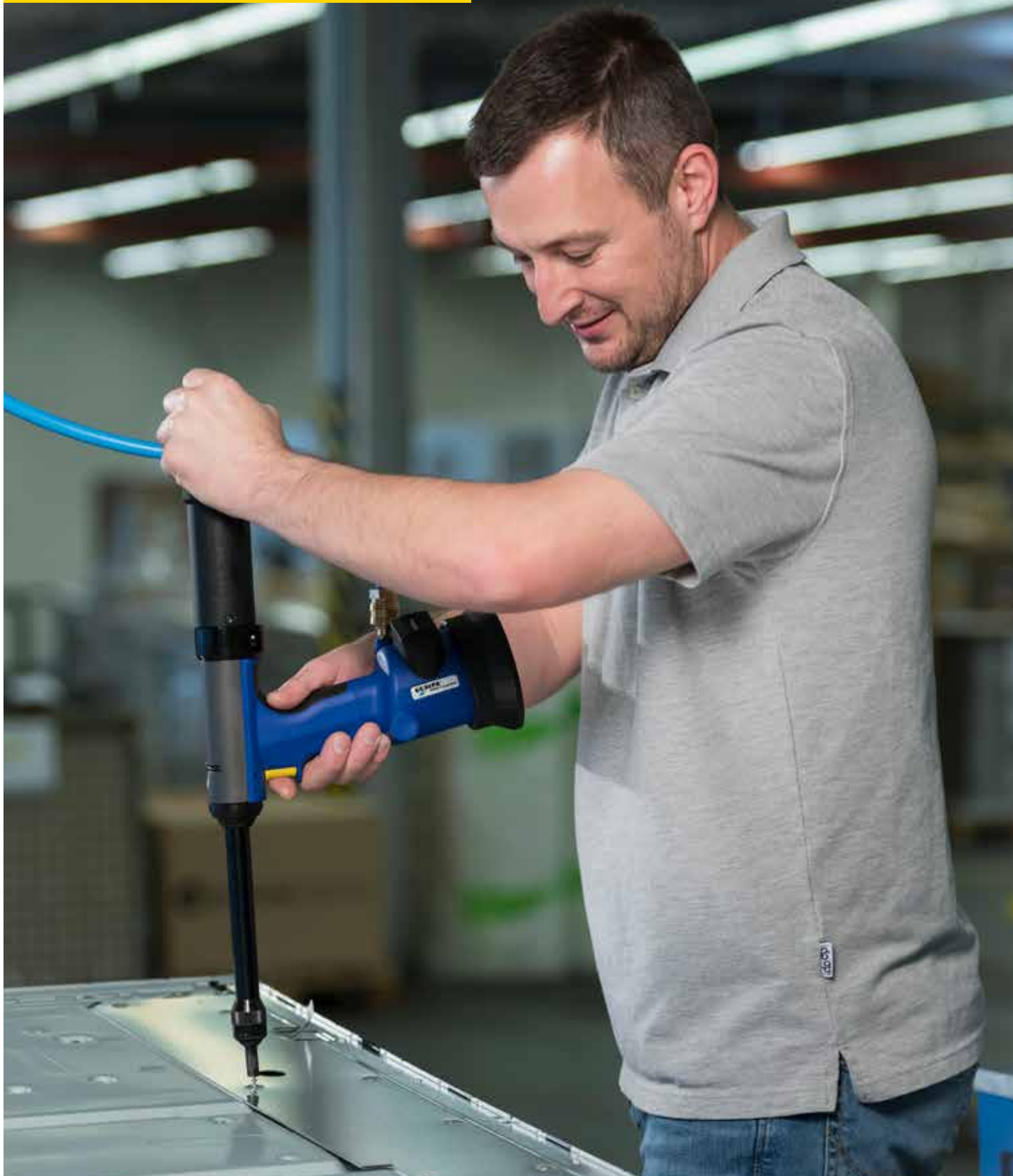

## Speed Rivet Technology – Fasteners and setting tools from a single source

Speed rivet technology is a joining method that requires access from only one side and which enables fast cycle times thanks to the preloaded rivets and automatic feed. After the setting operation the tool automatically makes the next rivet available. This technology is predominantly used in the industry, electronics, lighting, light-weight construction and aviation. Simple one-hand operation ensures rapid hole location and subsequent implementation of the joining process.

A particular feature of the GESIPA® Speed Rivet Technology is that the speed rivet is immediately ready for use. The disposable mandrel with captive speed rivets ensures the speed rivets are immediately ready for use, thus guaranteeing fast loading and fast magazine change (the joining elements do not need to be inserted individually by hand in the processing tool).

The relevant application of the rivet magazine is indicated by a distinct colour marking. With GESIPA® Speed Rivet Technology no spent mandrel remains in the joint after riveting.

Speed riveting technology completes GESIPA Blindnietechnik GmbH's product portfolio. The new speed rivet setting tools by GESIPA® are the product of decades of expertise and the unbeatable advantages of the wellknown, tried-and-tested TAURUS® series. Our engineers' main objectives in its development were for the Speed Rivet tools to be safe, quick and reliable. The very light and ergonomically shaped device will set new standards.

### THE SETTING PROCESS

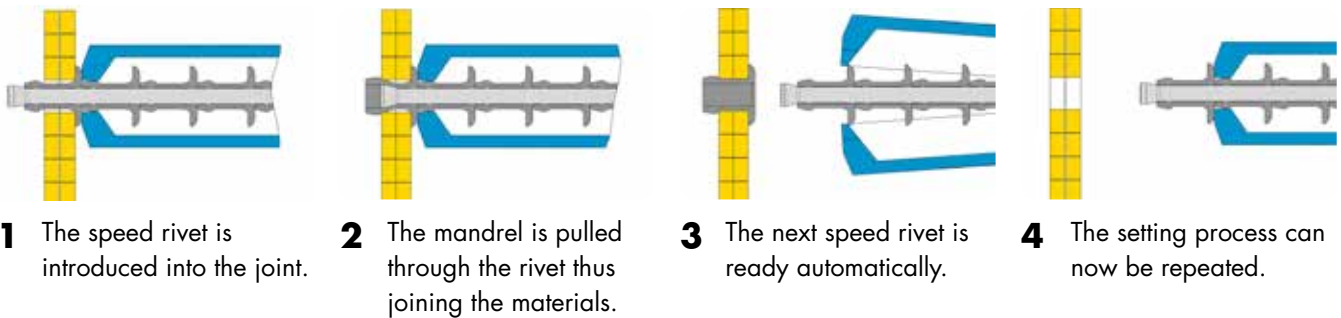

### ADVANTAGES OF THE GESIPA® SPEED RIVET

- Ready to use rivet magazine
- Extremely fast processing and cycle times
- Quick magazine change
- One-hand operation
- Vibration-proof
- Stable in use
- Reduced parts handling
- Versatile application
- Easy to operate
- Ideal for medium- and high-volume production
- No spent mandrel, therefore:
  - No corrosion
  - No lost mandrels
  - No noise
  - No short-circuits caused by loose parts
- Joining elements cannot drop off during processing
- Low-price alternative to fully automatic systems
- Made in Germany

# OVERVIEW GESIPA® SPEED RIVET TECHNOLOGY

## SPEED RIVETS

153

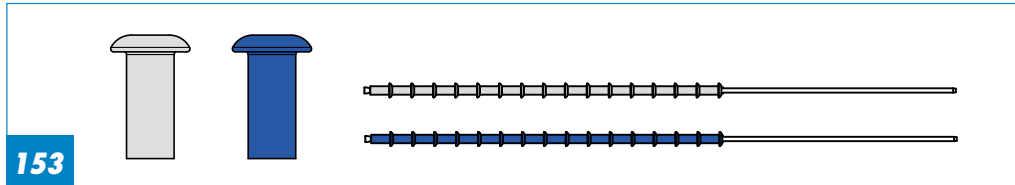

G-Speed® alu and steel

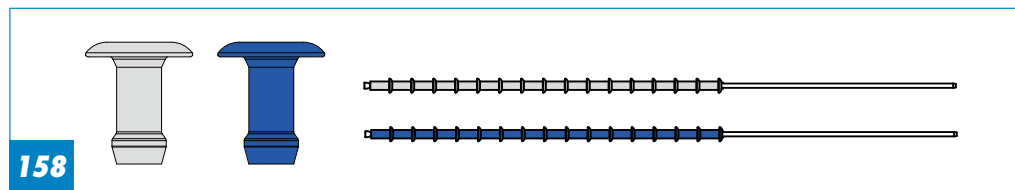

Speed Bulb® alu and steel

## SPEED RIVET SETTING TOOLS

163



TAURUS® 1 Speed Rivet



TAURUS® 2 Speed Rivet



TAURUS® 1 and 2 Speed Rivet Axial eco

## WHAT RIVETS WHAT?

		Ø mm							
		2.4	3.0	3.2	4.0	4.8	5.0	6.0	6.4
TAURUS® 1 Speed Rivet / Axial	P	●	●	●	●	A			
TAURUS® 2 Speed Rivet / Axial	P	●	●	●	●	●	●	●	●

**P:** Hydro-pneumatic tool

**A:** Alu/Copper

**S:** Steel

**E:** Stainless Steel/Monel

**Blue box:** All materials (ASE) can be riveted. Where there are exceptions, the letters of the rivetable materials are provided directly in the box..



# G-SPEED®

**G-Speed® the multi-range speed rivet from GESIPA® for a wide range of applications.**



## ADVANTAGES

- Large grip range
- Reduced variation
- Optimum hole filling capabilities and bearing stress
- Ideally suited for transferring shear strengths with moderate clamping force
- Ideal for:
  - LED light strips
  - Electronic/pcb assembly
  - Lightweight sheet metal structures
  - PC housings
  - Rating plates
  - Blind holes

Two mandrel lengths are available for the speed rivet:

**S ≈ 485 mm** for the standard nosepiece

**L ≈ 510 mm** for the long or curved nosepieces

To achieve an optimum riveted joint for different bore diameters, a number of mandrel size groups are available. The application range of each speed rivet is denoted by a clear colour code, ensuring the unequivocal classification of the mandrel size groups.

Grip range	+++
Shear strength	++
Tensile strength	+
Pulling strength	++



4



## CLASSIFICATION OF THE MANDREL SIZE GROUPS

mandrel size groups	Hollow-rivet diameter (mm)			
	3.0	3.2	4.0	4.8
	Bore diameter (mm)			
Standard	3.05 - 3.15	3.25 - 3.35	4.05 - 4.15	4.85 - 4.95
1st oversize	3.15 - 3.25	3.35 - 3.45	4.15 - 4.25	4.95 - 5.05
2nd oversize (on request)	3.25 - 3.35	3.45 - 3.55	4.25 - 4.35	5.05 - 5.15
3rd oversize (on request)	3.35 - 3.45	3.55 - 3.65	4.35 - 4.45	5.15 - 5.25

# G-SPEED®

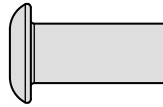

## Alu Dome head



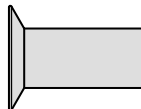

D	D x L mm	 mm	Number of rivets on mandrel ± 1		Mandrel length for nosepiece	*	*
						No.	No.
<b>3.2</b>	<b>3.2 x 4.0</b>	1.0 - 3.0	57	20,000	L4 (485 mm)	<b>146 3628</b>	<b>146 3636</b>
					L5 (510 mm)	<b>146 3975</b>	<b>146 3981</b>
	<b>3.2 x 5.5</b>	1.0 - 4.5	45	15,000	L4 (485 mm)	<b>146 3629</b>	<b>146 3637</b>
					L5 (510 mm)	<b>146 3979</b>	<b>146 3982</b>
	<b>3.2 x 7.0</b>	1.0 - 6.0	37	12,500	L4 (485 mm)	<b>146 3630</b>	<b>146 3638</b>
					L5 (510 mm)	<b>146 4006</b>	<b>146 4011</b>
	<b>3.2 x 8.5</b>	1.0 - 7.5	31	10,000	L4 (485 mm)	<b>146 3631</b>	<b>146 3639</b>
					L5 (510 mm)	<b>146 4007</b>	<b>146 4012</b>
<b>4.0</b>	<b>4.0 x 4.0</b>	1.0 - 3.0	57	20,000	L4 (485 mm)	<b>151 9021</b>	<b>151 9125</b>
					L5 (510 mm)	<b>151 9198</b>	<b>151 9302</b>
	<b>4.0 x 5.5</b>	1.0 - 4.5	45	15,000	L4 (485 mm)	<b>151 9023</b>	<b>151 9126</b>
					L5 (510 mm)	<b>151 9199</b>	<b>151 9303</b>
	<b>4.0 x 7.0</b>	1.0 - 6.0	37	12,500	L4 (485 mm)	<b>151 9025</b>	<b>151 9127</b>
					L5 (510 mm)	<b>151 9200</b>	<b>151 9305</b>
	<b>4.0 x 8.5</b>	1.0 - 7.5	31	10,000	L4 (485 mm)	<b>151 9026</b>	<b>151 9128</b>
					L5 (510 mm)	<b>151 9201</b>	<b>151 9306</b>
<b>4.8</b>	<b>4.8 x 4.0</b>	1.0 - 3.0	54	15,000	L4 (485 mm)	<b>151 9041</b>	<b>151 9133</b>
					L5 (510 mm)	<b>151 9206</b>	<b>151 9360</b>
	<b>4.8 x 5.5</b>	1.0 - 4.5	43	12,500	L4 (485 mm)	<b>151 9042</b>	<b>151 9134</b>
					L5 (510 mm)	<b>151 9207</b>	<b>151 9361</b>
	<b>4.8 x 7.0</b>	1.0 - 6.0	35	10,000	L4 (485 mm)	<b>151 9043</b>	<b>151 9135</b>
					L5 (510 mm)	<b>151 9219</b>	<b>151 9362</b>
	<b>4.8 x 8.5</b>	1.0 - 7.5	30	10,000	L4 (485 mm)	<b>151 9044</b>	<b>151 9136</b>
					L5 (510 mm)	<b>151 9218</b>	<b>151 9363</b>

## Alu Countersunk





D	D x L mm	 mm	Number of rivets on mandrel ± 1		Mandrel length for nosepiece	*	*
						No.	No.
<b>3.2</b>	<b>3.2 x 4.0</b>	1.0 - 3.0	75	25,000	L4 (485 mm)	<b>146 3660</b>	<b>146 3668</b>
					L5 (510 mm)	<b>146 4047</b>	<b>146 4054</b>
	<b>3.2 x 5.5</b>	1.0 - 4.5	55	20,000	L4 (485 mm)	<b>146 3661</b>	<b>146 3669</b>
					L5 (510 mm)	<b>146 4048</b>	<b>146 4055</b>
	<b>3.2 x 7.0</b>	1.0 - 6.0	43	15,000	L4 (485 mm)	<b>146 3662</b>	<b>146 3670</b>
					L5 (510 mm)	<b>146 4049</b>	<b>146 4056</b>
<b>3.2 x 8.5</b>	1.0 - 7.5	35	12,500	L4 (485 mm)	<b>146 3663</b>	<b>146 3671</b>	
				L5 (510 mm)	<b>146 4050</b>	<b>146 4057</b>	

D	D x L mm	 mm	Number of rivets on mandrel ± 1		Mandrel length for nosepiece	*	*
						No.	No.
4.0	4.0 x 4.0	1.0 - 3.0	75	25,000	L4 (485 mm)	151 9027	151 9129
					L5 (510 mm)	151 9202	151 9308
	4.0 x 5.5	1.0 - 4.5	55	17,500	L4 (485 mm)	151 9028	151 9130
					L5 (510 mm)	151 9203	151 9356
	4.0 x 7.0	1.0 - 6.0	43	15,000	L4 (485 mm)	151 9029	151 9131
					L5 (510 mm)	151 9204	151 9357
	4.0 x 8.5	1.0 - 7.5	35	12,500	L4 (485 mm)	151 9030	151 9132
					L5 (510 mm)	151 9205	151 9359
4.8	4.8 x 4.0	1.0 - 3.0	75	20,000	L4 (485 mm)	151 9046	151 9137
					L5 (510 mm)	151 9217	151 9364
	4.8 x 5.5	1.0 - 4.5	55	15,000	L4 (485 mm)	151 9047	151 9138
					L5 (510 mm)	151 9216	151 9365
	4.8 x 7.0	1.0 - 6.0	43	12,500	L4 (485 mm)	151 9048	151 9139
					L5 (510 mm)	151 9214	151 9366
	4.8 x 8.5	1.0 - 7.5	35	10,000	L4 (485 mm)	151 9050	151 9140
					L5 (510 mm)	151 9213	151 9367

## Steel

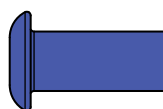
Dome head





D	D x L mm	 mm	Number of rivets on mandrel ± 1		Mandrel length for nosepiece	*	*
						No.	No.
3.2	3.2 x 4.0	1.0 - 3.0	57	20,000	L4 (485 mm)	146 4076	146 4084
					L5 (510 mm)	146 4168	146 4176
	3.2 x 5.5	1.0 - 4.5	45	15,000	L4 (485 mm)	146 4077	146 4085
					L5 (510 mm)	146 4169	146 4177
	3.2 x 7.0	1.0 - 6.0	37	12,500	L4 (485 mm)	146 4078	146 4086
					L5 (510 mm)	146 4170	146 4178
	3.2 x 8.5	1.0 - 7.5	31	10,000	L4 (485 mm)	146 4079	146 4087
					L5 (510 mm)	146 4171	146 4179
4.0	4.0 x 4.0	1.0 - 3.0	57	20,000	L4 (485 mm)	151 9059	151 9152
					L5 (510 mm)	151 9260	151 9369
	4.0 x 5.5	1.0 - 4.5	45	15,000	L4 (485 mm)	151 9060	151 9154
					L5 (510 mm)	151 9281	151 9389
	4.0 x 7.0	1.0 - 6.0	37	12,500	L4 (485 mm)	146 4507	146 4505
					L5 (510 mm)	146 4495	146 4493
	4.0 x 8.5	1.0 - 7.5	31	10,000	L4 (485 mm)	146 4506	146 4504
					L5 (510 mm)	146 4494	146 4492



153

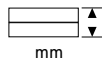

Other oversizes available on request. For details see table on **page 153** and **page 157**

D	D x L mm	 mm	Number of rivets on mandrel ± 1		Mandrel length for nosepiece	*	*
						No.	No.
4.8	4.8 x 4.0	1.0 - 3.0	54	15,000	L4 (485 mm)	151 9073	151 9157
					L5 (510 mm)	151 9284	151 9441
	4.8 x 5.5	1.0 - 4.5	43	12,500	L4 (485 mm)	151 9078	151 9159
					L5 (510 mm)	151 9285	151 9442
	4.8 x 7.0	1.0 - 6.0	35	10,000	L4 (485 mm)	151 9082	151 9160
					L5 (510 mm)	151 9286	151 9443
	4.8 x 8.5	1.0 - 7.5	30	10,000	L4 (485 mm)	151 9109	151 9161
					L5 (510 mm)	151 9287	151 9444

## Steel

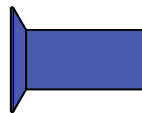
Countersunk head

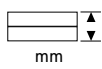



D	D x L mm	 mm	Number of rivets on mandrel ± 1		Mandrel length for nosepiece	*	*
						No.	No.
3.2	3.2 x 4.0	1.0 - 3.0	75	25,000	L4 (485 mm)	146 4136	146 4144
					L5 (510 mm)	146 4200	146 4208
	3.2 x 5.5	1.0 - 4.5	55	20,000	L4 (485 mm)	146 4137	146 4145
					L5 (510 mm)	146 4201	146 4209
	3.2 x 7.0	1.0 - 6.0	43	15,000	L4 (485 mm)	146 4138	146 4146
					L5 (510 mm)	146 4202	146 4210
	3.2 x 8.5	1.0 - 7.5	35	12,500	L4 (485 mm)	146 4139	146 4147
					L5 (510 mm)	146 4203	146 4211
4.0	4.0 x 4.0	1.0 - 3.0	75	25,000	L4 (485 mm)	151 9071	151 9155
					L5 (510 mm)	151 9282	151 9390
	4.0 x 5.5	1.0 - 4.5	55	17,500	L4 (485 mm)	151 9072	151 9156
					L5 (510 mm)	151 9283	151 9391
	4.0 x 7.0	1.0 - 6.0	43	15,000	L4 (485 mm)	146 4499	146 4498
					L5 (510 mm)	146 4487	146 4486
	4.0 x 8.5	1.0 - 7.5	35	12,500	L4 (485 mm)	146 4912	146 4911
					L5 (510 mm)	146 4910	146 4909
4.8	4.8 x 4.0	1.0 - 3.0	75	20,000	L4 (485 mm)	151 9121	151 9190
					L5 (510 mm)	151 9288	151 9445
	4.8 x 5.5	1.0 - 4.5	55	15,000	L4 (485 mm)	151 9122	151 9191
					L5 (510 mm)	151 9289	151 9446
	4.8 x 7.0	1.0 - 6.0	43	12,500	L4 (485 mm)	151 9123	151 9194
					L5 (510 mm)	151 9290	151 9447
	4.8 x 8.5	1.0 - 7.5	35	10,000	L4 (485 mm)	151 9124	151 9196
					L5 (510 mm)	151 9301	151 9461



153

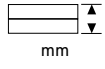

Other oversizes available on request. For details see table on **page 153** and **page 157**

G-Speed® is available in a large number of versions  
The individual properties are shown in the following table of possible combinations

Head shape	Material	D mm	D x L mm	 mm	Number of rivets on mandrel ± 1 Dome head	Number of rivets on mandrel ± 1 Countersunk head	
Dome head / Countersunk	Alu/Steel	3.0	3.0 x 2.5	1.0 - 1.5	81	115	30,000
			3.0 x 4.0	1.0 - 3.0	57	75	20,000
			3.0 x 5.5	1.0 - 4.5	45	55	15,000
			3.0 x 7.0	1.0 - 6.0	37	43	12,500
			3.0 x 8.5	1.0 - 7.5	31	35	10,000
			3.0 x 10.0	1.0 - 9.0	27	26	10,000
		3.2	3.2 x 2.5	1.0 - 1.5	81	115	30,000
			3.2 x 10.0	1.0 - 9.0	27	30	10,000
			3.2 x 11.5	1.0 - 10.5	23	26	10,000
			3.2 x 13.0	1.0 - 12.0	21	23	10,000
		4.0	4.0 x 2.5	1.0 - 1.5	85	115	30,000
			4.0 x 10.0	1.0 - 9.0	27	30	10,000
			4.0 x 11.5	1.0 - 10.5	23	26	10,000
			4.0 x 13.0	1.0 - 12.0	21	23	7,500 / 10,000
		4.8	4.8 x 2.5	1.0 - 1.5	75	115	20,000 / 30,000
			4.8 x 10.0	1.0 - 9.0	26	30	7,500 / 10,000
			4.8 x 11.5	1.0 - 10.5	23	26	7,500
			4.8 x 13.0	1.0 - 12.0	20	23	5,000 / 7,500
			4.8 x 14.5	1.0 - 13.5	18	20	5,000
			4.8 x 16.0*	1.0 - 15.0	17	18	5,000

**Example:** Countersunk head– Steel 3.0 x 10.0 mm

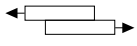
## SHEAR STRENGTH G-SPEED®\*

D mm	 N Alu	 N Steel	max. k mm	max. d <sub>k</sub> mm
<b>DOME HEAD ALU AND STEEL</b>				
3.0	630	1,060	1.2	5.5
3.2	900	1,400	1.2	5.5
4.0	1,600	2,400	1.5	6.5
4.8	2,000	3,200	1.5	8.9
<b>COUNTERSUNK HEAD ALU AND STEEL</b>				
3.0	630	1,060	1.0	5.5
3.2	900	1,400	1.0	5.7
4.0	1,600	2,400	1.0	6.7
4.8	2,000	3,200	1.4	9.1

D = Rivet body Ø  
k = Height of head  
d<sub>k</sub> = Setting head Ø

\*Typical data,  
measured at the longest  
rivet body length

# SPEED BULB®

The GESIPA® Speed Bulb® is designed for high and dynamic loads



## ADVANTAGES

- Optimally adapted to specific grip range
- Distinct bulb formation
  - High grip force
  - High pulling force
- For higher loads
- Ideally suited for transmitting shear and tensile forces
- Ideal for:
  - Higher dynamic loads
  - Sheet metal structures
  - Electrical devices
  - White goods

Grip range	++
Shear strength	++
Tensile strength	++
Pulling strength	+++



Two mandrel lengths are available for the speed rivet:

**L4 ≈ 485 mm** for the standard nose

**L5 ≈ 510 mm** for the long or curved nosepieces

To achieve an optimum riveted joint for different bore diameters, a number of mandrel size groups are available. The application range of each speed rivet is denoted by a clear colour code, ensuring the unequivocal classification of the mandrel size groups.

## CLASSIFICATION OF THE MANDREL SIZE GROUPS



mandrel size groups:	Hollow-rivet diameter (mm)		
	3.2	4.0	4.8
	Bore diameter (mm)		
Standard	3.25 - 3.35	4.05 - 4.15	4.85 - 4.95
1st oversize	3.35 - 3.45	4.15 - 4.25	4.95 - 5.05
2nd oversize (on request)	3.45 - 3.55	4.25 - 4.35	5.05 - 5.15

# SPEED BULB®

## Alu

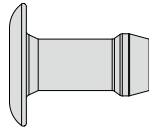
Dome head

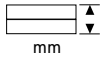



D	D x L mm	 mm	Number of rivets on mandrel ± 1		Mandrel length for nosepiece	*	*
						No.	No.
3.2	3.2 x 4.2	1.0 - 2.3	59	17,500	L4 (485 mm)	151 9636	151 9645
					L5 (510 mm)	151 9646	151 9729
	3.2 x 4.7	1.5 - 2.8	54	17,500	L4 (485 mm)	151 9731	151 9742
					L5 (510 mm)	151 9775	152 0860
	3.2 x 5.2	2.0 - 3.3	49	15,000	L4 (485 mm)	151 9732	151 9743
					L5 (510 mm)	151 9776	152 0833
	3.2 x 6.2	3.0 - 4.3	42	12,500	L4 (485 mm)	151 9733	151 9744
					L5 (510 mm)	151 9777	152 0836
	3.2 x 7.2	4.0 - 5.3	37	12,500	L4 (485 mm)	151 9734	151 9745
					L5 (510 mm)	151 9778	152 0837
	3.2 x 8.2	5.0 - 6.3	33	10,000	L4 (485 mm)	151 9735	151 9750
					L5 (510 mm)	151 9779	152 0838

## Steel

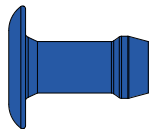
Dome head

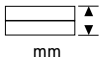

D	D x L mm	 mm	Number of rivets on mandrel ± 1		Mandrel length for nosepiece	*	*
						No.	No.
3.2	3.2 x 4.2	1.0 - 2.3	59	17,500	L4 (485 mm)	151 9644	151 9727
					L5 (510 mm)	151 9728	151 9730
	3.2 x 4.7	1.5 - 2.8	54	17,500	L4 (485 mm)	151 9736	151 9760
					L5 (510 mm)	152 0855	152 0839
	3.2 x 5.2	2.0 - 3.3	49	15,000	L4 (485 mm)	151 9737	151 9771
					L5 (510 mm)	152 0856	152 0840
	3.2 x 6.2	3.0 - 4.3	42	12,500	L4 (485 mm)	151 9738	151 9772
					L5 (510 mm)	152 0857	152 0871
	3.2 x 7.2	4.0 - 5.3	37	12,500	L4 (485 mm)	151 9740	151 9773
					L5 (510 mm)	152 0858	152 0872
	3.2 x 8.2	5.0 - 6.3	33	10,000	L4 (485 mm)	151 9741	151 9774
					L5 (510 mm)	152 0859	152 0873





158

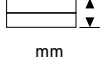

Other oversizes available on request. For details see table on **page 158** and **page 160**

# SPEED BULB®

Speed Bulb® is available in a large number of versions.  
The individual properties are shown in the following table of possible combinations.

Head shape	Material	D mm	D x L mm	 mm	Number of rivets on mandrel ± 1	
Dome head	Alu/Steel	3.2	3.2 x 3.7	0.5 - 1.8	65	20,000
			3.2 x 9.2	6.0 - 7.3	29	10,000
			3.2 x 10.2	7.0 - 8.3	27	10,000
			3.2 x 11.2	8.0 - 9.3	25	10,000
		4.0	4.0 x 4.3	1.0 - 2.3	57	17,500
			4.0 x 4.8	1.5 - 2.8	52	17,500
			4.0 x 5.3	2.0 - 3.3	48	15,000
			4.0 x 6.3	3.0 - 4.3	41	15,000
			4.0 x 7.3	4.0 - 5.3	36	12,500
			4.0 x 8.3	5.0 - 6.3	32	12,500
			4.0 x 9.3	6.0 - 7.3	29	12,500
			4.0 x 10.3	7.0 - 8.3	26	10,000
		4.8	4.0 x 11.3	8.0 - 9.3	24	10,000
			4.8 x 5.2	1.5 - 2.8	47	12,500
			4.8 x 5.7	2.0 - 3.3	43	10,000
			4.8 x 6.7	3.0 - 4.3	38	10,000
			4.8 x 7.2	3.5 - 4.8	35	10,000
			4.8 x 7.7	4.0 - 5.3	34	10,000
			4.8 x 8.7	5.0 - 6.3	30	7,500
			4.8 x 9.7	6.0 - 7.3	27	7,500
		4.8 x 10.7	7.0 - 8.3	25	7,500	
		4.8 x 11.7	8.0 - 9.3	23	7,500	

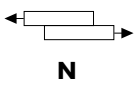
## SHEAR AND TENSILE STRENGTH SPEED BULB®\*

D mm	 N	 N	max. k mm	max. d <sub>k</sub> mm
<b>DOMED HEAD ALU</b>				
3.2	700	1,300	1.0	6.6
4.0	1,100	1,700	1.0	8.3
4.8	1,500	2,700	1.2	9.8
<b>DOMED HEAD STEEL</b>				
3.2	1,100	1,800	1.0	6.6
4.0	1,600	2,800	1.0	8.3
4.8	2,200	3,700	1.2	9.8

D = Rivet body Ø  
k = Height of head  
d<sub>k</sub> = Setting head Ø

\*Typical data,  
measured at the longest  
rivet body length



# TAURUS® 1 SPEED RIVET

The hydro-pneumatic-magazine setting tool with quick setting process and fast rates!

No. 145 7684

## TECHNICAL DATA

Traction power:	3,500 N at 6 bar
Stroke:	26 mm
Operating pressure:	5-7 bar
Air hose connection:	6 mm Ø (1/4")
Weight:	1.8 kg

## WORKING RANGE

The rivet setting tool is designed for setting standard speed rivets from 2.4 - 4.8 mm Ø of all materials, as well as up to 4 mm Ø in stainless steel.

## SCOPE OF DELIVERY

Tag on device head  
1 hydraulic oil bottle 100 ml  
1 oil refill can  
1 oil press  
Operating instructions with spare parts list



## ADVANTAGES

- Quick setting process, fast rates
- Safe working through disposable mandrel and optional automatic switchoff
- Ergonomic handling for fatigue-free work
- Light and compact design
- Modular construction based on the TAURUS® design
- Softgrip
- Tool-free conversion (spreader nosepiece and spring)

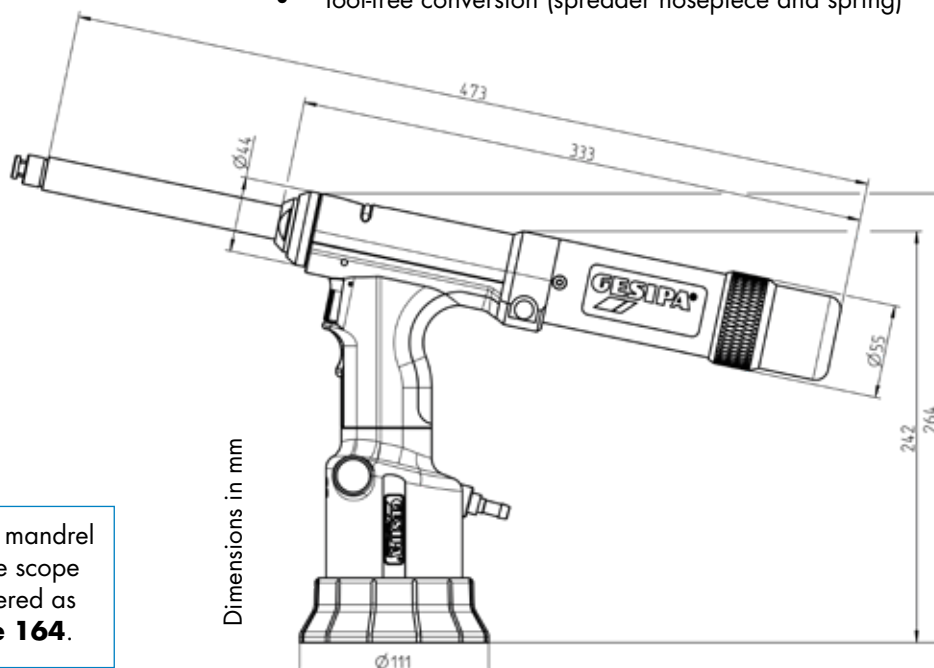

The spreader nosepiece and mandrel spring are not included in the scope of delivery. They can be ordered as special accessories on **page 164**.

# TAURUS® 2 SPEED RIVET

The hydro-pneumatic-magazine setting tool with quick setting process and fast rates!

No. 145 7833

## TECHNICAL DATA

Traction power:	6,500 N at 6 bar
Stroke:	30 mm
Operating pressure:	5-7 bar
Air hose connection:	6 mm Ø (1/4")
Weight:	2.0 kg

## WORKING RANGE

The rivet setting tool is designed for setting standard speed rivets from 2.4 - 6.4 mm Ø of all materials.

## SCOPE OF DELIVERY

Tag on device head  
1 hydraulic oil bottle 100 ml  
1 oil refill can  
1 oil press  
Operating instructions with spare parts list

## ADVANTAGES

- Quick setting process, fast rates
- Safe working through disposable mandrel and optional automatic switchoff
- Ergonomic handling for fatigue-free work
- Light and compact design
- Modular construction based on the TAURUS® design
- Softgrip
- Tool-free conversion (spreader nosepiece and spring)



The spreader nosepiece and mandrel spring are not included in the scope of delivery. They can be ordered as special accessories on **page 170**.

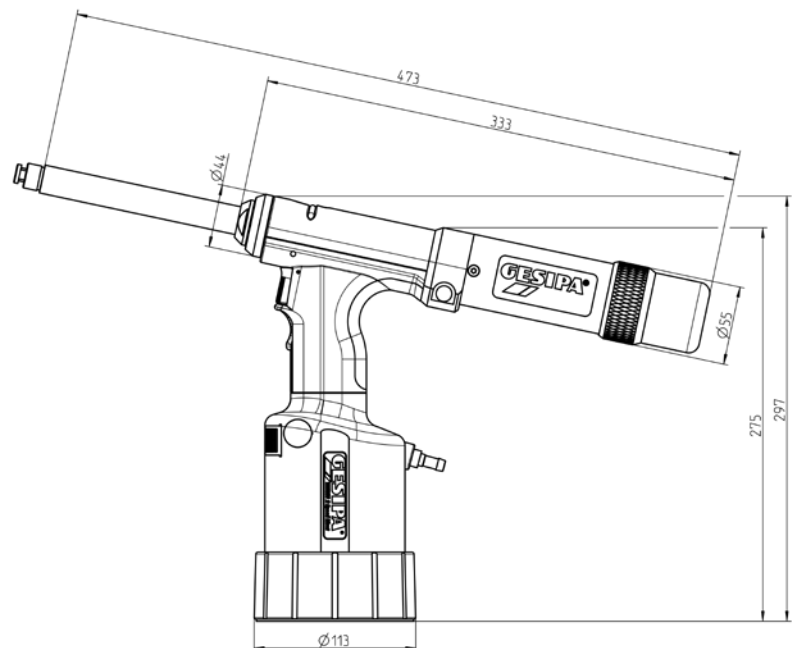

Dimensions in mm

# TAURUS® SPEED RIVET AXIAL ECO 1/2

**Axial version of the speed riveting setting tool for special applications**



## TAURUS® 1 Speed Rivet Axial Eco No. 145 7692

Technical data and working range  
analog to TAURUS® 1 and 2 Speed Rivet.

### SCOPE OF DELIVERY

- 1 hydraulic oil bottle 100 ml
- 1 oil refill can
- 1 oil press
- Operating instructions with spare parts list

### ADVANTAGES

- Also perfectly designed for fixed installation in production lines or semi-automatic workstations
- Very practical for processing blind rivets in positions that require a vertical rivet setting process
- Can be suspended on a balancer
- Quick setting process, fast rates
- Safe working through disposable mandrel and optional automatic switchoff
- Ergonomic handling for fatigue-free work
- Light and compact design
- Modular construction based on the TAURUS® design
- Softgrip
- Tool-free conversion (spreader nosepiece and spring)



The spreader nosepiece and mandrel spring are not included in the scope of delivery. They can be ordered as special accessories on **page 164**.

## TAURUS® 2 Speed Rivet Axial Eco No. 145 0931

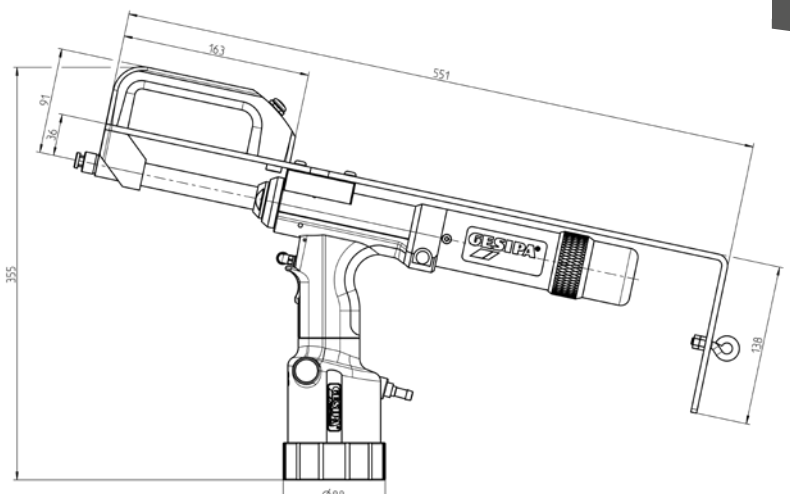

Dimensions in mm

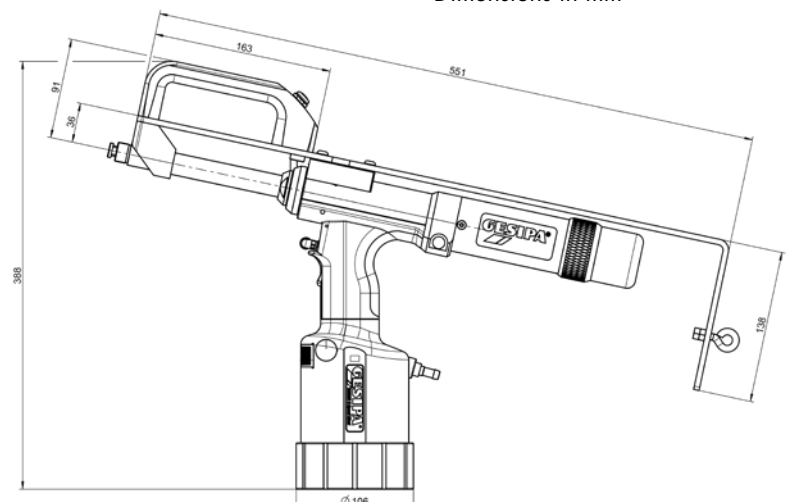

# SPECIAL ACCESSORIES Speed rivet technology

## NOSEPIECES

- **Standard:** For easy to access riveting points
- **Standard pointed:** For countersunk head rivets
- **Extended and extended bent:** For difficult to access riveting points
- **With opening mechanism:** Makes it easier to open the nosepiece so that speed rivets can be changed more conveniently and quickly.



## MANDREL SPRING

- **Standard:** For standard spreader nosepiece with or without opening mechanism.
- **Extended:** For extended spreader nosepiece with or without opening mechanism.

	Rivet Ø (mm)	No.
<b>Standard</b>	2.4	155 3517
	3.2	145 7759
	4.0	145 7761
	4.8	145 7763
<b>Extended</b>	3.2	145 7760
	4.0	145 7762
	4.8	145 7764



## SPREADER NOSEPIECE WITHOUT OPENING MECHANISM

	Rivet Ø (mm)	No.	Ø d (mm)	Ø D (mm)	L1 (mm)	L2 (mm)
<b>Standard</b>	2.4	155 6918	5	9.5	31	64
	3.2	145 7753	6	10.5		
	4.0	145 7754	7.5	12		
	4.8	145 7755	9	14		
<b>Extended</b>	3.2	145 7756	6	10.5	57	90
	4.0	145 7757	7.5	12		
	4.8	145 7758	9	14		
<b>Standard pointed</b>	3.2	145 0900	6	10.5	31	64
	4.0	145 0901	7.5	12		
	4.8	145 0902	9	14		
<b>Extended bent</b>	3.2	145 0903	6	10.5	55	88
	4.0	145 0904	7.5	12	55.5	88.5
	4.8	145 0905	9	14	56	89

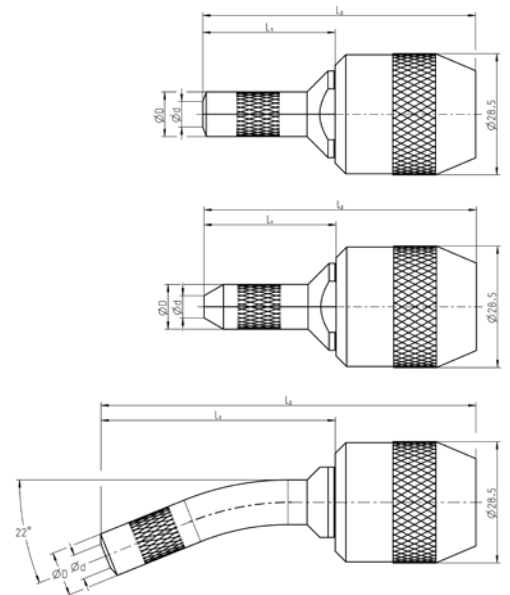

## SPREADER NOSEPIECE WITH OPENING MECHANISM

	Rivet $\varnothing$ (mm)	No.	$\varnothing d$ (mm)	$\varnothing D$ (mm)	L1 (mm)	L2 (mm)
Standard	2.4	155 6919	5	9.5	31	67
	3.2	145 0906	6	10.5		
	4.0	145 0907	7.5	12		
	4.8	145 0908	9	14		
Extended	3.2	145 0909	6	10.5	57	92
	4.0	145 0910	7.5	12		
	4.8	145 0911	9	14		
Standard pointed	3.2	145 0912	6	10.5	31	67
	4.0	145 0913	7.5	12		
	4.8	145 0914	9	14		
Extended bent	3.2	145 0915	6	10.5	55	91
	4.0	145 0916	7.5	12		
	4.8	145 0917	9	14	56	

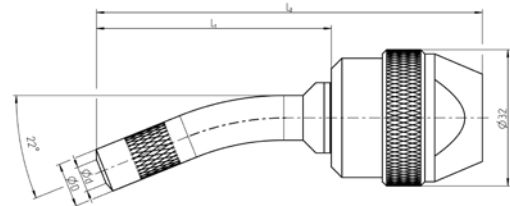
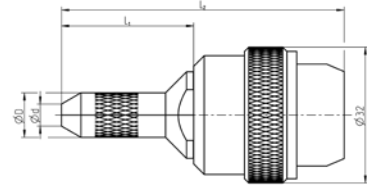
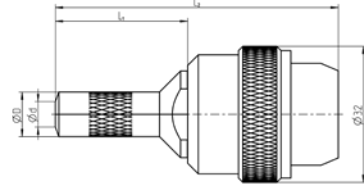

Other spreader nosepieces and mandrel springs on request.

## GUIDE TUBE

The short guide tube means that TAURUS® Speed Rivet setting tools can work with the standard L4 mandrel length even with long and curved nosepieces.

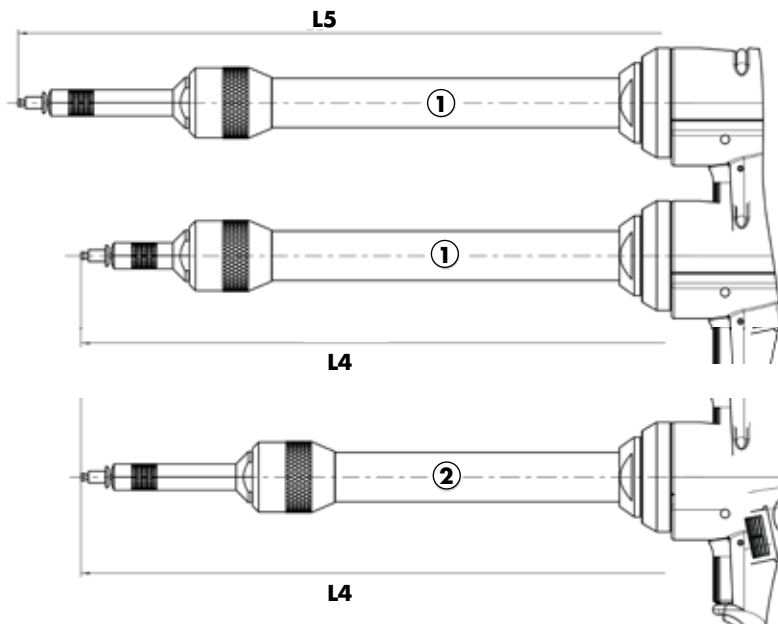

**Standard 1**  
**No. 143 5710**

L5 mandrel length required **L5 ≈ 510 mm** for a long or curved nosepiece

Suitable for standard mandrel length **L4 L4 ≈ 485 mm** for standard nosepiece

**Shortened 2**  
**No. 163 9244**

Suitable for standard mandrel length **L4 L4 ≈ 485 mm** for a long or curved nosepiece

# LOCK BOLT SETTING TOOLS

**Innovative, strong and reliable – connections are last long and free from vibration.**



Lockbolts are used where there are particularly high requirements regarding the durability and vibration safety of the connection. The connection requires the components of the lockbolt to be accessible from two sides. Because the locking ring moulds into the retaining grooves during the setting process, the connection is extremely durable and secure against coming loose on its own.

The GESIPA® lock bolt setting devices in the TAURUS® series have been developed using a modular concept and are an ideal composition of experience and consistent further development by our experienced engineers. The lockbolt setting devices guarantee high-quality setting processes and therefore long-lasting and permanently tight connections. In the truck & trailer field in particular, GESIPA® devices ensure fast, trouble-free working processes.

## Fastening material by means of lockbolts

With standard lockbolts, the setting process itself is very similar to the blind riveting process.

1. The pin is positioned on one side and the collar on the other side of the materials to be joined.
2. The setting tool grasps the pin while pushing itself against the collar.
3. By pulling the pin the application materials are pressed together and the collar is forced into the grooves of the pin.
4. The joining process is finished once the setting tool hits the joint's surface and the pin breaks off at the predetermined fracture point because of the increasing tensile strength.

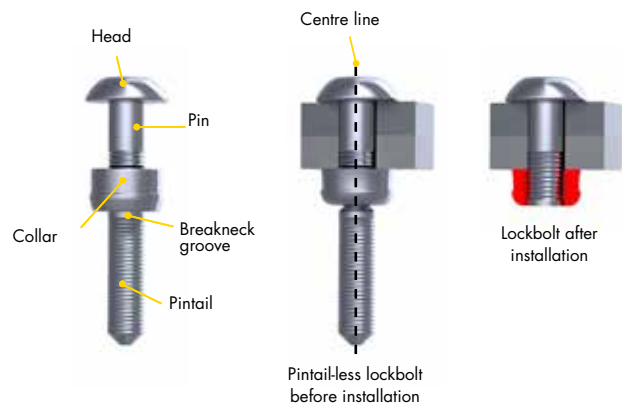

167 TAURUS® 3 SRB



168 TAURUS® 4 SRB



169 TAURUS® 4 SRB with angle head 90° compact

# TAURUS® 3 SRB

**TAURUS® 3** For lockbolts 4.8 mm  
Magna-Grip®

**No. 145 0953**

**TAURUS® 3** for  
lockbolts 4.8mm C6L

**No. 145 0952**

\*Registered trademark  
of Alcoa Fastening Systems

## TECHNICAL DATA

Weight:	2.0 kg
Operating air pressure:	5 - 7 bar
Air hose connection Ø:	6 mm
Air consumption:	4.8 NL / stroke
Traction power:	18,000 N at 6 bar
Stroke:	25 mm

## WORKING RANGE

4.8 lockbolts MagnaGrip®\* and C6L

## SCOPE OF DELIVERY

- 1 hydraulic oil bottle 100 ml
- 1 oil refill can
- Hanger on tool head
- Operating instructions with spare parts list

## ADVANTAGES

- Specially adjusted stroke for setting lockbolts
- Very high tensile strength allows fast setting
- Extremely handy and lightweight due to its compact design
- Economic consumption of compressed air
- Minimum wear and tear due to use of pulling head modules with jaws respectively adjusted in their numbers of parts
- Efficient operation through extraction of spent mandrels
- Large spent mandrel container
- Attractive price-performance ratio
- Modular structure

## JAW MECHANISM ASSIGNMENT

For lockbolts 4.8 mm Magna-Grip®

Designation	No.
Nosepiece	<b>143 4810</b>
Jaw	<b>144 6118</b>
Jaw housing	<b>143 5945</b>



**!** The suitability of nosepiece and fastener needs to be tested by the user and is user's own responsibility!

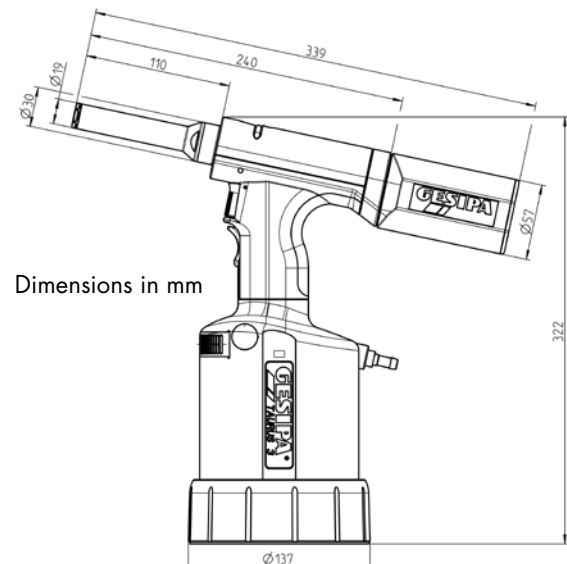

Dimensions in mm

For lockbolts 4.8 mm C6L

Designation	No.
Nosepiece	<b>143 4809</b>
Supporting ring	<b>143 5995</b>
Jaw	<b>144 6117</b>
Jaw housing	<b>143 5944</b>

# TAURUS® 4 SRB

**TAURUS® 4** for lockbolts  
6.4 mm (1/4") Magna-Grip®\*

**No. 145 0986**

**TAURUS® 4** for lockbolts  
6.4 mm (1/4") C6L

**No. 145 0985**

\*Registered trademark  
of Alcoa Fastening Systems

## TECHNICAL DATA

Weight: 2.2 kg  
Operating air pressure: 5-7 bar  
Schlauchanschluss: 6 mm Ø (1/4")  
Air hose connection: ca. 4.8 ltr. pro Niet  
Setting force: 23,000 N at 6 bar  
Stroke: 19 mm

## WORKING RANGE

6.4 lockbolts MagnaGrip®\* and C6L

## SCOPE OF DELIVERY

1 hydraulic oil bottle 100 ml  
1 oil refill can  
Operating instructions with spare parts list  
Hanger on tool head

## ADVANTAGES

- Specially adjusted stroke for setting lockbolts
- Very high tensile strength allows fast setting
- Extremely handy and lightweight due to its compact design
- Economic consumption of compressed air
- Minimum wear and tear due to use of pulling head modules with jaws respectively adjusted in their numbers of parts
- Efficient operation through extraction of spent mandrels
- Large spent mandrel container
- Attractive price-performance ratio
- Modular structure

## JAW MECHANISM ASSIGNMENT

For lockbolts 6.4 mm (1/4") Magna-Grip®\*

Designation	No.
Nosepiece	<b>143 5942</b>
Supporting ring	<b>143 5943</b>
Jaw	<b>144 6105</b>
Jaw housing	<b>143 5997</b>

For lockbolts 6.4 mm (1/4") C6L

Designation	No.
Nosepiece	<b>143 5993</b>
Supporting ring	<b>143 5995</b>
Jaw	<b>144 6116</b>
Jaw housing	<b>143 5997</b>



**!** The suitability of nosepiece and fastener needs to be tested by the user and is user's own responsibility!

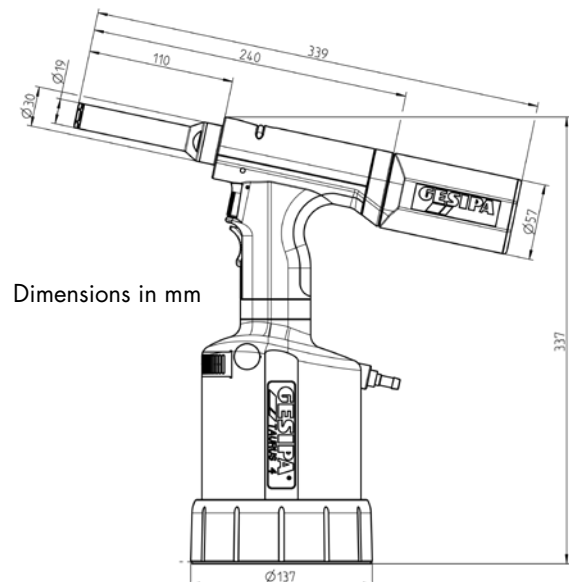

Dimensions in mm



# TAURUS® 4 SRB with angle head 90° compact

**TAURUS® 4** for SRB 6.4 mm  
MagnaGrip®\*

**No. 145 7990**

**TAURUS® 4**

for SRB 6.4 mm C6L

**No. 145 7989**

\*Registered trademark  
of Alcoa Fastening Systems

## TECHNICAL DATA

Weight:	2.6 kg
Operating air pressure:	5-7 bar
Air hose connection:	6 mm Ø (1/4")
Air consumption:	approx. 4.8 NL per rivet
Setting force:	23,000 N at 6 bar
Stroke:	19 mm

## WORKING RANGE

6.4 lockbolts MagnaGrip®\* and C6L

## SCOPE OF DELIVERY

- Angle head with nosepiece in working position
- Swivelling hanger
- 1 hydraulic oil bottle 100 ml
- 1 oil refill can
- Operating instructions with spare parts list

## ADVANTAGES

- Hydro-pneumatic lock bolt setting device
- Accessibility in tight working spaces
- Light and compact design
- Modular structure
- Ergonomic handling

## JAW MECHANISM ASSIGNMENT

For lockbolts 6.4 mm (1/4") Magna-Grip®\*

Designation	No.
Nosepiece	<b>143 5942</b>
Supporting ring	<b>143 5943</b>
Jaw	<b>144 6105</b>
Jaw housing	<b>143 5997</b>

For lockbolts 6.4 mm (1/4") C6L

Designation	No.
Nosepiece	<b>143 5993</b>
Supporting ring	<b>143 5995</b>
Jaw	<b>144 6116</b>
Jaw housing	<b>143 5997</b>



**!** The suitability of nosepiece and fastener needs to be tested by the user and is user's own responsibility!

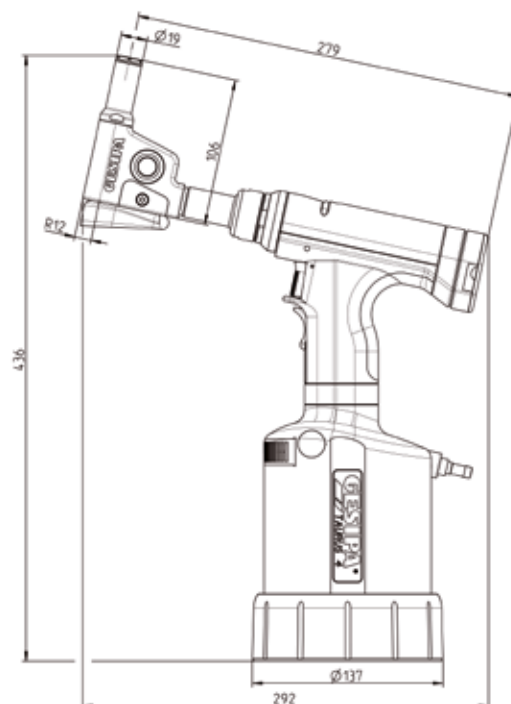

# **BLIND RIVET NUTS TECHNOLOGY**

- » trust
- » move
- » know
- » understand
- » create



# BLIND RIVETS

GESIPA® BLIND RIVET NUT TECHNOLOGY GIVES YOU A MULTITUDE OF BENEFITS!

**Easy and quick** assembly, and the component only needs to be accessed from one side.

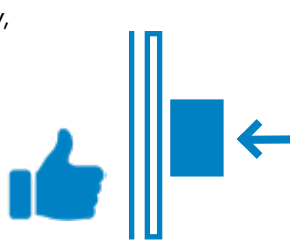

Placement of **high-quality** threads in **thin** and **soft** materials (steel, aluminium, magnesium, plastic, etc.)

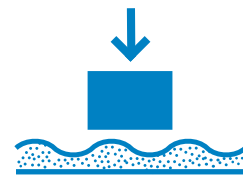

No thermal influences on the components and therefore **no thermal distortion** or damage to the surfaces of the components. No reworking is necessary.



**High** degree of **flexibility** in the production process.

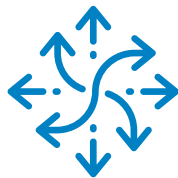

Production of **watertight** and **gas-tight** connections.



**No emission** of heat, smoke or welding fumes into the surrounding area and therefore no danger to people or the environment.



**Low investment** for assembly equipment. Versatile, can also be used for hybrid joints and soft materials.



# GESIPA® BLIND RIVET NUTS

## JOINING ELEMENT WITH THREAD

GESIPA® blind rivet nuts and blind rivet studs are joining elements used to produce load-bearing, high stress threads for non-permanent connections. Blind rivet nuts have an inside thread whereas blind rivet studs have an outside thread (threaded pin). As with blind rivets, two or more components can be joined with both joining elements.

## APPLICATION-OPTIMISED JOINING ELEMENTS

By manufacturing the joining elements ourselves at the GESIPA® production sites we are able to implement specific customer requirements economically and efficiently. We are the specialists for application-optimised blind rivet nuts and blind rivet studs.

## APPLICATIONS

Blind rivet nuts and blind rivet studs are used in the most diverse areas of trade and industry – wherever a strong, non-permanent connection needs to be made. For example:

- Automotive
- White goods
- Heating and air conditioning
- Electronics
- Solar
- Construction
- Food

## PROCESSING

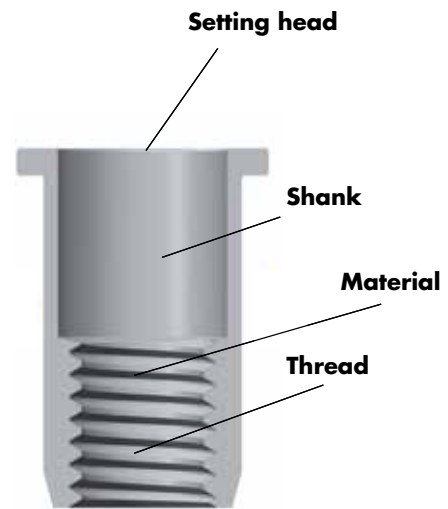

## GESIPA® BLIND RIVET NUT – TERMINOLOGY

The setting head is the part of the blind rivet nut that rests on the visible surface of the component. The user can choose between the following variants:

- **Dome head** – for a large contact surface on the component
- **Small head** – for minimum overlap of the blind rivet nut thus allowing the component to rest almost flat
- **Countersunk head** – for flat surfaces in countersunk holes

The **shank** is the part of the blind rivet nut that deforms during the setting procedure and fixes the blind rivet nut in the component. The so-called bulb is formed in this process. The user can choose from the following variants: Round, Knurled and Polygon (hexagon or square)

### The material

Specific to the application, the customer can use blind rivet nuts made from steel, aluminium or stainless steel.

### The thread

The GESIPA® blind rivet nuts have a metric thread as standard. The steel blind rivet nuts meet the requirements of strength class 8.8. Other dimensions, such as imperial or coarse thread, are available on request.

# TECHNICAL DATA

- » high quality
- » tested
- » safe



## YOUR BENEFIT

The specified forces and torques correspond to calculated values or values determined in tests. They aim to help the user select the suitable fastener. GESIPA® recommends testing the blind rivet nuts in the application. The actual values may differ from the information in the catalogue due to different circumstances. Please contact our technical team for further help and advice.

## THE SETTING PROCESS

The picture shows a diagram of the force-stroke curve for setting a blind rivet nut in the lower clamping range. Initially the force rises steeply because the deformation zone of the blind rivet nut is first compressed. Once a certain force is reached, the deformation zone starts to fold outwards. Due to the fact that the resistance of the material is lower during the deformation and creation of the closing head, the force drops slightly.

## FORCE DIAGRAM FOR A SETTING PROCESS

When the closing head meets the backside of the application, the pulling force starts increasing again. To ensure that the blind rivet nut sits tightly on the application material and does not slip when subjected to torque, the closing head must lie completely flat on the joining material (see cross-sections of the blind rivet nuts on the following page). If the setting process is not interrupted, the force will continue to rise until the thread is destroyed.

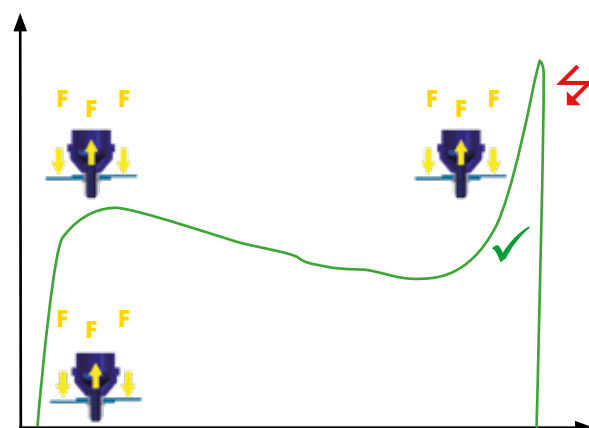

# TECHNICAL DATA

## SCHEMATIC LAYOUT FOR THE TORQUE TEST

The tightening torque [(Nm) or (lb-ft)] specifies the maximum torque with which the screw can be tightened.

For testing, GESIPA® uses screws of the strength class 10.9 or higher that are free of all lubricants. A hardened washer is used as the clamping part. The test is carried out in the lower and the upper clamping range, where the blind rivet nuts are loaded with the specified torque. Then the screw is screwed out again.



The thread must still turn smoothly in order to pass the test. Then the blind rivet nut is loaded again up to the overtorque.

## SCHEMATIC LAYOUT FOR THE THREAD TEAR-OUT TEST

The maximum bearable axial load on the thread is the thread breaking force [(N) and (kp)]. GESIPA® uses screws of the strength class 10.9 or higher that are free of all lubricants for the test. The test takes place in the lower and upper clamping range.

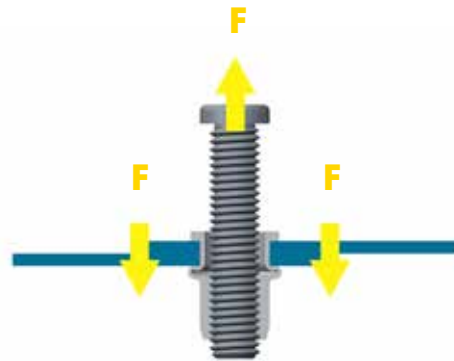

## THE TIGHTENING TORQUE (NM) AND (LB-FT)

	Alu		Steel		Stainless steel A2 / A4 / Monel®	
	Nm	(lb-ft)	Nm	(lb-ft)	Nm	(lb-ft)
<b>M4</b>	<b>2.5</b>	1.8	<b>3.0</b>	2.2	<b>5.5</b>	4.1
<b>M5</b>	<b>5.0</b>	3.7	<b>8.0</b>	5.9	<b>14.0</b>	10.3
<b>M6</b>	<b>9.5</b>	7.0	<b>12.0</b>	8.9	<b>27.0</b>	19.9
<b>M8</b>	<b>17.5</b>	12.9	<b>30.0</b>	22.1	<b>40.0</b>	29.5
<b>M10</b>	<b>28.0</b>	20.7	<b>38.0</b>	28.0	-	-

## THREAD BREAKING FORCE (N) AND (KP)

	Alu		Steel		Stainless steel A2 / A4 / Monel®	
	N	(kp)	N	(kp)	N	(kp)
<b>M4</b>	<b>4,800</b>	489	<b>8,000</b>	815	<b>10,000</b>	1,019
<b>M5</b>	<b>5,700</b>	581	<b>11,500</b>	1,172	<b>15,000</b>	1,529
<b>M6</b>	<b>9,500</b>	968	<b>18,000</b>	1,836	<b>&gt; 25,000</b>	2,548
<b>M8</b>	<b>13,000</b>	1,325	<b>28,000</b>	2,853	<b>&gt; 30,000</b>	3,057
<b>M10</b>	<b>14,000</b>	1,427	<b>30,000</b>	3,057	-	-

# TECHNICAL DATA

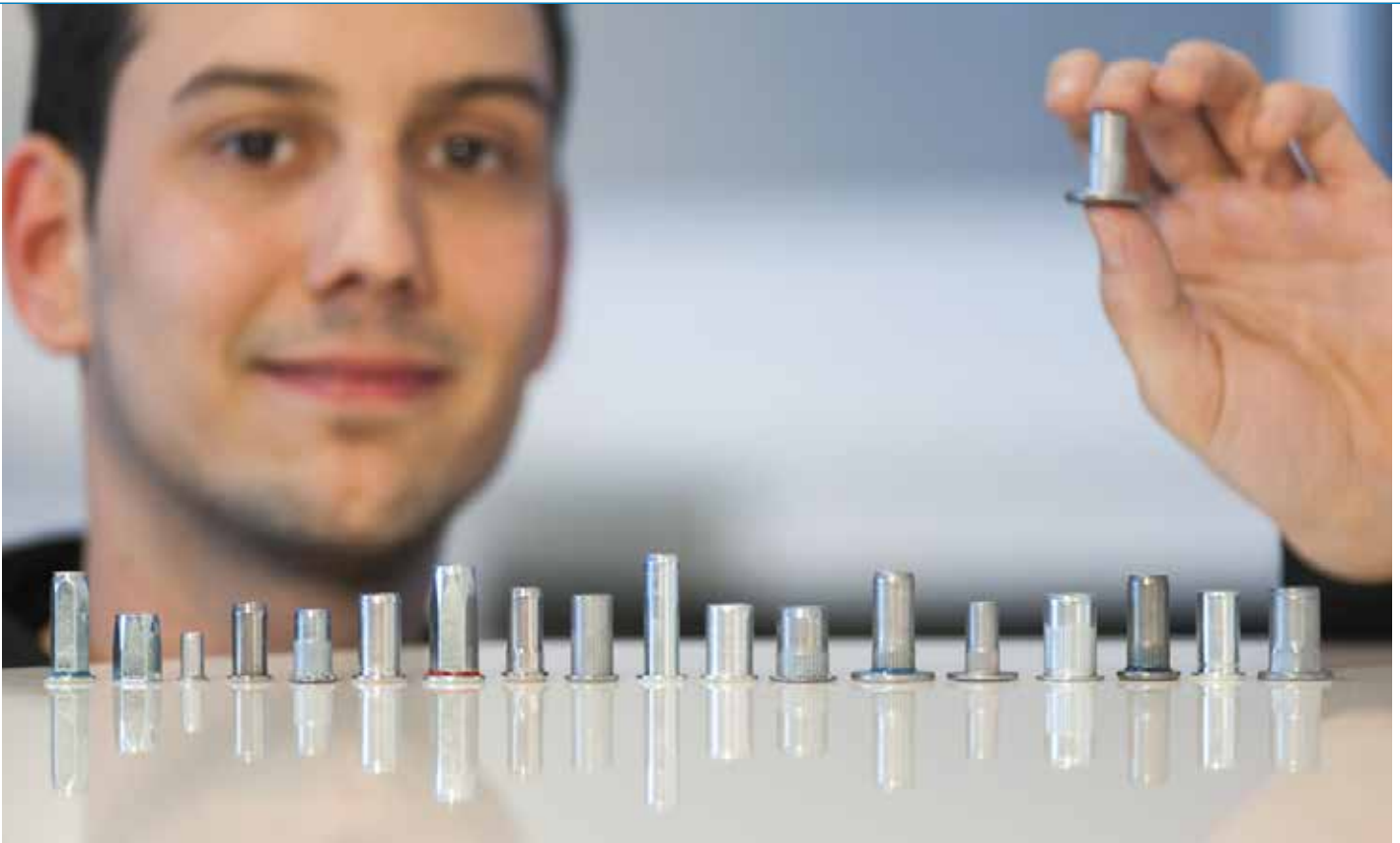

## GESIPA® BLIND RIVET NUTS – DIMENSIONS

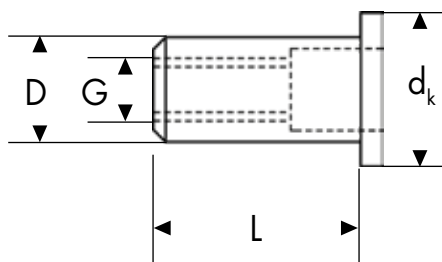

- D = Rivet nut body  $\varnothing$
- L = Rivet nut body length
- $d_k$  = Setting head  $\varnothing$
- G = Thread dimension

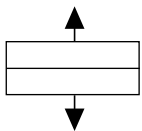

Shear strength

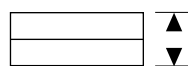

Grip range



Hole  $\varnothing = d_h$

# BLIND RIVET NUTS RANGE

## STANDARD







177								
	Alu	Steel splined	Steel square bodied	Steel half hexagonal				
	181		182		183		184	
		Stainless steel A2		Stainless steel A2 half hexagonal		Stainless steel A4		Stainless steel A4 half hexagonal
185		186		187				
						Monel®	Alu closed end (CAP®)	Steel closed end (CAP®)
188								
	Light Weight	High Strength	Torque resistant	G-Sealed®				
	194		194		194		194	
195		196		199		199		
								PolyGrip® splined steel
200		201						
				 All steel blind rivet nuts are splined!				

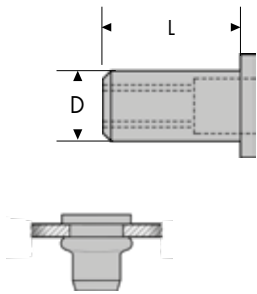

# BLIND RIVET NUTS ALU Material: AlMg 3





## Standard Dome head

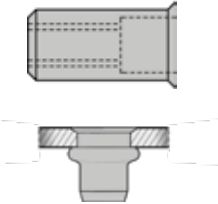

D	D x L mm	 mm	No.	
<b>M 4</b>  6.1 mm	<b>6 x 11.0</b>	0.25 - 3.0	<b>143 3676</b>	A 500
	<b>6 x 13.0</b>	2.5 - 4.5	<b>143 3677</b>	"
<b>M 5</b>  7.1 mm	<b>7 x 11.5</b>	0.25 - 3.0	<b>143 3678</b>	A 500
	<b>7 x 13.5</b>	2.5 - 5.0	<b>143 3679</b>	"
<b>M 6</b>  9.1 mm	<b>9 x 15.5</b>	0.25 - 3.5	<b>143 3680</b>	A 250
	<b>9 x 18.0</b>	3.0 - 5.5	<b>143 3681</b>	"
<b>M 8</b>  11.1 mm	<b>11 x 17.0</b>	0.25 - 3.5	<b>143 3682</b>	A 100
	<b>11 x 20.0</b>	3.0 - 6.0	<b>143 3683</b>	"
<b>M 10</b>  12.1 mm	<b>12 x 17.5</b>	0.25 - 3.5	<b>143 3684</b>	A 100
	<b>12 x 20.5</b>	3.0 - 6.0	<b>145 5345</b>	"







## Small head

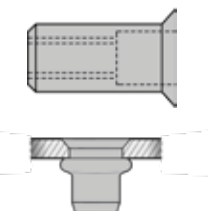

D	D x L mm	 mm	No.	
<b>M 4</b>  6.1 mm	<b>6 x 12.0</b>	0.5 - 3.0	<b>143 3685</b>	A 500
<b>M 5</b>  7.1 mm	<b>7 x 12.5</b>	0.5 - 3.0	<b>143 3686</b>	A 500
<b>M 6</b>  9.1 mm	<b>9 x 15.5</b>	0.5 - 3.5	<b>143 3687</b>	A 250

## Countersunk (90°)







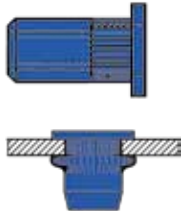

D	D x L mm	 mm	No.	
<b>M 4</b>  6.1 mm	<b>6 x 12.0</b>	1.5 - 3.5	<b>145 5346</b>	A 500
	<b>6 x 13.5</b>	3.0 - 5.0	<b>145 5347</b>	"
<b>M 5</b>  7.1 mm	<b>7 x 13.5</b>	1.5 - 4.0	<b>145 5348</b>	A 500
	<b>7 x 15.5</b>	3.5 - 6.0	<b>145 5349</b>	"
<b>M 6</b>  9.1 mm	<b>9 x 17.0</b>	1.5 - 4.5	<b>145 5350</b>	A 250
	<b>9 x 19.0</b>	4.0 - 6.5	<b>145 5351</b>	"
<b>M 8</b>  11.1 mm	<b>11 x 18.5</b>	1.5 - 4.5	<b>145 5352</b>	A 100
	<b>11 x 20.5</b>	4.0 - 6.5	<b>145 5353</b>	"
<b>M 10</b>  12.1 mm	<b>12 x 19.0</b>	1.5 - 4.5	<b>145 5354</b>	A 100
	<b>12 x 21.0</b>	4.0 - 6.5	<b>145 5355</b>	"

# BLIND RIVET NUTS STEEL SPLINED Material: Steel, zinc-plated

## Standard







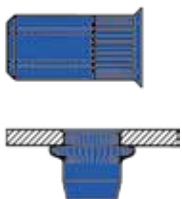

D	D x L mm	 mm	No.	
<b>M 4</b>  6.1 mm	<b>6 x 11.0</b>	0.25 - 3.0	<b>143 3703</b>	A 500
	<b>6 x 13.0</b>	2.5 - 4.5	<b>145 5362</b>	"
<b>M 5</b>  7.1 mm	<b>7 x 11.5</b>	0.25 - 3.0	<b>143 3704</b>	A 500
	<b>7 x 13.5</b>	2.5 - 5.0	<b>143 3705</b>	"
<b>M 6</b>  9.1 mm	<b>9 x 15.5</b>	0.25 - 3.5	<b>143 3706</b>	A 250
	<b>9 x 18.0</b>	3.0 - 5.5	<b>145 5363</b>	"
	<b>9 x 21.0</b>	5.5 - 8.0	<b>145 0364**</b>	A 200
<b>M 8</b>  11.1 mm	<b>11 x 17.0</b>	0.25 - 3.5	<b>143 3707</b>	A 100
	<b>11 x 20.0</b>	3.0 - 6.0	<b>143 3708*</b>	"
	<b>11 x 21.5</b>	6.0 - 9.0	<b>145 0366*</b>	"
<b>M 10</b>  12.1 mm	<b>11 x 25.5</b>	9.0 - 12.0	<b>145 0367*</b>	"
	<b>12 x 17.5</b>	0.25 - 3.5	<b>143 3709</b>	A 100
	<b>12 x 20.5</b>	3.0 - 6.0	<b>143 3710</b>	"

\*Cannot be used with the standard mandrel + nosepiece. A longer mandrel + nosepiece, or a conversion kit for DIN screws, is needed for this, page 223, 237, 243, 245 and page 207/208 (\*\*does not apply to GMB 40-R /GBM 50)

## Small head









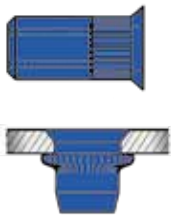

D	D x L mm	 mm	No.	
<b>M 4</b>  6.1 mm	<b>6 x 12.0</b>	0.25 - 3.0	<b>143 3711</b>	A 500
	<b>M 5</b>  7.1 mm	<b>7 x 12.5</b>	0.25 - 3.0	<b>143 3712</b>
<b>M 6</b>  9.1 mm	<b>9 x 15.5</b>	0.25 - 3.5	<b>143 3713</b>	A 250
	<b>9 x 19.0</b>	3.5 - 5.5	<b>145 0368</b>	"
	<b>9 x 22.0</b>	5.5 - 8.0	<b>145 0369**</b>	"
<b>M 8</b>  11.1 mm	<b>11 x 17.0</b>	0.25 - 3.5	<b>143 3714</b>	A 100
	<b>11 x 21.0</b>	3.5 - 5.5	<b>145 0370*</b>	"
	<b>11 x 23.0</b>	5.5 - 9.0	<b>145 0371*</b>	"
<b>M 10</b>  12.1 mm	<b>12 x 18.0</b>	1.5 - 4.5	<b>146 4890</b>	A 100
	<b>12 x 20.0</b>	4.0 - 6.5	<b>146 4889</b>	"

\*Cannot be used with the standard mandrel + nosepiece. A longer mandrel + nosepiece, or a conversion kit for DIN screws, is needed for this, page 223, 237, 243, 245 and page 207/208 (\*\*does not apply to GMB 40-R /GBM 50)

# BLIND RIVET NUTS STEEL SPLINED Material: Steel, zinc-plated

## Countersunk (90°)



D	D x L mm	 mm	No.	
<b>M 4</b>  6.1 mm	<b>6 x 12.0</b>	1.5 - 3.5	<b>145 5365</b>	A 500
	<b>6 x 13.5</b>	3.0 - 5.0	<b>145 5366</b>	"
<b>M 5</b>  7.1 mm	<b>7 x 13.5</b>	1.5 - 4.0	<b>145 5367</b>	A 500
	<b>7 x 15.5</b>	3.5 - 6.0	<b>145 5368</b>	"
<b>M 6</b>  9.1 mm	<b>9 x 17.0</b>	1.5 - 4.5	<b>145 5369</b>	A 250
	<b>9 x 19.0</b>	4.0 - 6.5	<b>145 5370</b>	"
	<b>9 x 23.0</b>	6.5 - 9.0	<b>145 0372**</b>	A 200
<b>M 8</b>  11.1 mm	<b>11 x 18.5</b>	1.5 - 4.5	<b>143 3715</b>	A 100
	<b>11 x 20.5</b>	4.0 - 6.5	<b>145 5371*</b>	"
	<b>11 x 23.0</b>	6.5 - 9.0	<b>145 0373*</b>	"
<b>M 10</b>  12.1 mm	<b>12 x 19.0</b>	1.5 - 4.5	<b>145 5372</b>	A 100
	<b>12 x 21.0</b>	4.0 - 6.5	<b>145 5373</b>	"

\*Cannot be used with the standard mandrel + nose piece. A longer mandrel + nose piece, or a conversion kit for DIN screws, is needed for this, page 223, 237, 243, 245 and page 207/208 (\*\*does not apply to GMB 40-R /GBM 50)



The maximum tightening torque and the threaded breaking force and shear strengths for all blind rivet nuts can be found on **page 174**. For head diameters, please report to **page 185**.





# BLIND RIVET NUTS STEEL

Material: Steel, zinc-plated

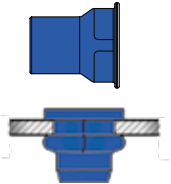
## Square bodied Standard

Dome head







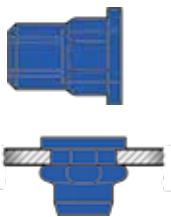

D	D x L mm	 mm	No.	
<b>M 5</b>  SW7.1 + 0.1	<b>7 x 12</b>	0.5 - 3.0	<b>146 4921</b>	A 500
<b>M 6</b>  SW9.1 + 0.1	<b>9 x 15.5</b>	0.5 - 3.0	<b>146 4922</b>	A 250
<b>M 8</b>  SW11.1 + 0.1	<b>11 x 17</b>	0.5 - 3.0	<b>146 4923</b>	A 100

## Half hexagonal Standard

Dome head







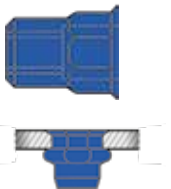

D	D x L mm	 mm	No.	
<b>M 4</b>  SW6 + 0.1	<b>6 x 11.0</b>	0.5 - 2.0	<b>145 5377</b>	A 500
<b>M 5</b>  SW7 + 0.1	<b>7 x 12.0</b>	0.5 - 3.0	<b>145 5378</b>	A 500
<b>M 6</b>  SW9 + 0.1	<b>9 x 15.5</b>	0.5 - 3.0	<b>145 5379</b>	A 250
<b>M 8</b>  SW11 + 0.1	<b>11 x 17.0</b>	0.5 - 3.0	<b>143 3716</b>	A 100

## Half hexagonal Small head

Small head



D	D x L mm	 mm	No.	
<b>M 4</b>  SW6 + 0.1	<b>6 x 11.0</b>	0.5 - 2.0	<b>145 5380</b>	A 500
<b>M 5</b>  SW7 + 0.1	<b>7 x 12.5</b>	0.5 - 3.0	<b>145 5381</b>	A 500
<b>M 6</b>  SW9 + 0.1	<b>9 x 15.5</b>	0.5 - 3.0	<b>145 5382</b>	A 250
<b>M 8</b>  SW11 + 0.1	<b>11 x 17.0</b>	0.5 - 3.0	<b>145 5383</b>	A 100



The maximum tightening torque and the threaded breaking force and shear strengths for all blind rivet nuts can be found on **page 174**. For head diameters, please report to **page 185**.





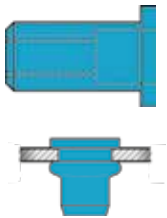

# BLIND RIVET NUTS STAINLESS STEEL A2

Material: Stainless steel A2 1.45677



## Standard Dome head







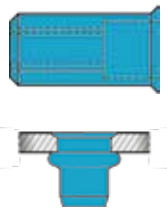

D	D x L mm	 mm	No.	
<b>M 4</b>  6.1 mm	<b>6 x 11.0</b>	0.25 - 3.0	<b>145 5444</b>	A 500
	<b>6 x 13.0</b>	2.5 - 4.0	<b>145 5445</b>	"
<b>M 5</b>  7.1 mm	<b>7 x 11.5</b>	0.25 - 3.0	<b>143 3725</b>	A 500
	<b>7 x 13.5</b>	2.5 - 4.5	<b>143 3726</b>	"
<b>M 6</b>  9.1 mm	<b>9 x 15.5</b>	0.25 - 3.5	<b>145 5446</b>	A 250
	<b>9 x 18.0</b>	3.0 - 5.5	<b>145 5447</b>	"
<b>M 8</b>  11.1 mm	<b>11 x 17.0</b>	0.25 - 3.5	<b>145 5448</b>	A 100
	<b>11 x 20.0</b>	3.0 - 6.0	<b>145 5449</b>	"

Material surcharge will be added at a daily rate

## Small head







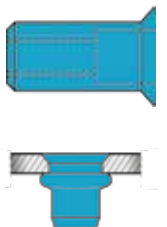

D	D x L mm	 mm	No.	
<b>M 4</b>  6.1 mm	<b>6 x 12.0</b>	0.25 - 3.0	<b>143 3727</b>	A 500
<b>M 5</b>  7.1 mm	<b>7 x 12.5</b>	0.25 - 3.0	<b>143 3728</b>	A 500
<b>M 6</b>  9.1 mm	<b>9 x 15.5</b>	0.25 - 3.5	<b>143 3729</b>	A 250
<b>M 8</b>  11.1 mm	<b>11 x 17.0</b>	0.25 - 3.5	<b>143 3730</b>	A 100

Material surcharge will be added at a daily rate

## Countersunk



D	D x L mm	 mm	No.	
<b>M 4</b>  6.1 mm	<b>6 x 12.0</b>	1.5 - 3.0	<b>143 3731</b>	A 500
	<b>6 x 13.0</b>	2.5 - 4.0	<b>145 5450</b>	"
<b>M 5</b>  7.1 mm	<b>7 x 13.5</b>	1.5 - 4.0	<b>143 3732</b>	A 500
	<b>7 x 15.5</b>	3.5 - 6.0	<b>145 5451</b>	"
<b>M 6</b>  9.1 mm	<b>9 x 17.0</b>	1.5 - 4.5	<b>143 3733</b>	A 250
	<b>9 x 18.5</b>	4.0 - 6.0	<b>145 5452</b>	"
<b>M 8</b>  11.1 mm	<b>11 x 18.5</b>	1.5 - 4.5	<b>143 3734</b>	A 100
	<b>11 x 20.0</b>	4.0 - 6.0	<b>145 5453</b>	"

Material surcharge will be added at a daily rate

# BLIND RIVET NUTS STAINLESS STEEL A2 HALF HEXAGONAL







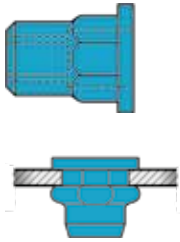

Material: Stainless steel A2 1.4567

## Standard

Dome head







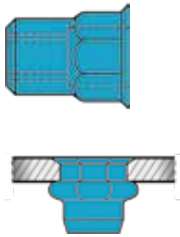

D	D x L mm	 mm	No.	
<b>M 4</b>  SW6 + 0.1	<b>6 x 11.0</b>	0.5 - 2.0	<b>145 5454</b>	A 500
<b>M 5</b>  SW7 + 0.1	<b>7 x 12.0</b>	0.5 - 3.0	<b>145 5455</b>	"
<b>M 6</b>  SW9 + 0.1	<b>9 x 15.5</b>	0.5 - 3.0	<b>145 5456</b>	A 250
<b>M 8</b>  SW11 + 0.1	<b>11 x 17.0</b>	0.5 - 3.0	<b>145 5457</b>	A 100

Material surcharge will be added at a daily rate

## Small head



D	D x L mm	 mm	No.	
<b>M 4</b>  SW6 + 0.1	<b>6 x 11.0</b>	0.5 - 2.0	<b>145 5458</b>	A 500
<b>M 5</b>  SW7 + 0.1	<b>7 x 12.0</b>	0.5 - 3.0	<b>145 5459</b>	"
<b>M 6</b>  SW9 + 0.1	<b>9 x 15.5</b>	0.5 - 3.0	<b>145 5460</b>	A 250
<b>M 8</b>  SW11 + 0.1	<b>11 x 17.0</b>	0.5 - 3.0	<b>145 5461</b>	A 100

Material surcharge will be added at a daily rate



The maximum tightening torque and the threaded breaking force and shear strengths for all blind rivet nuts can be found on **page 174**. For head diameters, please report to **page 185**.

# BLIND RIVET NUTS STAINLESS STEEL A4







Material: Stainless steel A4 1.4578

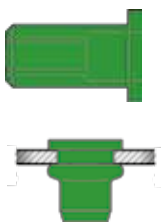

## Standard

Dome head







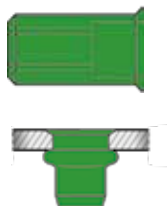

D	D x L mm	 mm	No.	
<b>M 4</b>  6.1 mm	<b>6 x 11.0</b>	0.25 - 3.0	<b>145 5468</b>	A 500
	<b>6 x 13.0</b>	2.5 - 4.0	<b>145 5473</b>	"
<b>M 5</b>  7.1 mm	<b>7 x 11.5</b>	0.25 - 3.0	<b>145 5475</b>	"
	<b>7 x 13.5</b>	2.5 - 4.5	<b>145 5478</b>	"
<b>M 6</b>  9.1 mm	<b>9 x 15.5</b>	0.25 - 3.5	<b>145 5462</b>	A 250
	<b>9 x 18.0</b>	3.0 - 5.5	<b>145 0381</b>	"
<b>M 8</b>  11.1 mm	<b>11 x 17.0</b>	0.25 - 3.5	<b>145 5480</b>	A 100
	<b>11 x 20.0</b>	3.0 - 6.0	<b>145 5485</b>	"

Material surcharge will be added at a daily rate

## Small head







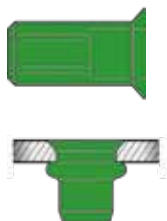

D	D x L mm	 mm	No.	
<b>M 4</b>  6.1 mm	<b>6 x 12.0</b>	0.25 - 3.0	<b>145 5472</b>	A 500
<b>M 5</b>  7.1 mm	<b>7 x 12.5</b>	0.25 - 3.0	<b>145 5476</b>	"
<b>M 6</b>  9.1 mm	<b>9 x 15.5</b>	0.25 - 3.5	<b>145 5465</b>	A 250
<b>M 8</b>  11.1 mm	<b>11 x 17.0</b>	0.25 - 3.5	<b>145 5481</b>	A 100

Material surcharge will be added at a daily rate

## Countersunk



D	D x L mm	 mm	No.	
<b>M 4</b>  6.1 mm	<b>6 x 12.0</b>	1.5 - 3.0	<b>145 5471</b>	A 500
	<b>6 x 13.0</b>	2.5 - 4.0	<b>145 5474</b>	"
<b>M 5</b>  7.1 mm	<b>7 x 13.5</b>	1.5 - 4.0	<b>145 5479</b>	"
	<b>7 x 15.5</b>	3.5 - 6.0	<b>145 0382</b>	"
<b>M 6</b>  9.1 mm	<b>9 x 17.0</b>	1.5 - 4.5	<b>145 5464</b>	A 250
	<b>9 x 18.5</b>	4.0 - 6.0	<b>145 5463</b>	"
<b>M 8</b>  11.1 mm	<b>11 x 18.5</b>	1.5 - 4.5	<b>145 5484</b>	A 100
	<b>11 x 20.0</b>	4.0 - 6.0	<b>145 5486</b>	"

Material surcharge will be added at a daily rate







# BLIND RIVET NUTS STAINLESS STEEL A4 HALF HEXAGONAL

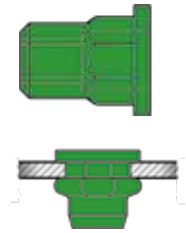

Material: Stainless steel A4 1.4578







## Standard Dome head

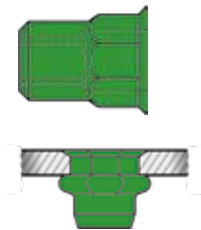

D	D x L mm	 mm	No.	
<b>M 4</b>  SW6 + 0.1	<b>6 x 11.0</b>	0.5 - 2.0	<b>145 5469</b>	A 500
<b>M 5</b>  SW7 + 0.1	<b>7 x 12.0</b>	0.5 - 3.0	<b>144 6456</b>	"
<b>M 6</b>  SW9 + 0.1	<b>9 x 15.5</b>	0.5 - 3.0	<b>145 5466</b>	A 250
<b>M 8</b>  SW11 + 0.1	<b>11 x 17.0</b>	0.5 - 3.0	<b>145 5482</b>	A 100

## Small head



D	D x L mm	 mm	No.	
<b>M 4</b>  SW6 + 0.1	<b>6 x 11.0</b>	0.5 - 2.0	<b>145 5470</b>	A 500
<b>M 5</b>  SW7 + 0.1	<b>7 x 12.0</b>	0.5 - 3.0	<b>145 5477</b>	"
<b>M 6</b>  SW9 + 0.1	<b>9 x 15.5</b>	0.5 - 3.0	<b>145 5467</b>	A 250
<b>M 8</b>  SW11 + 0.1	<b>11 x 17.0</b>	0.5 - 3.0	<b>145 5483</b>	A 100

Material surcharge will be added at a daily rate



The maximum tightening torque and the threaded breaking force and shear strengths for all blind rivet nuts can be found on **page 174**. For head diameters, please report to **page 185**.









# BLIND RIVET NUTS MONEL®

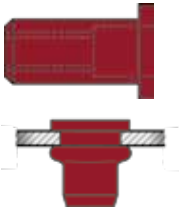

Material: Monel 400 NiCu30Fe 2.4360

## Standard Dome head



D	D x L mm	 mm	No.	
<b>M 5</b>  7.1 mm	<b>7 x 11.5</b>	0.25 - 3.0	<b>146 4292</b>	A 500
<b>M 6</b>  9.1 mm	<b>9 x 15.5</b>	0.25 - 3.5	<b>145 5489</b>	A 250
<b>M 8</b>  11.1 mm	<b>11 x 17.0</b>	0.25 - 3.5	<b>146 4291</b>	A 100

Material surcharge will be added at a daily rate

### SHAFT GEOMETRY ROUND AND SPLINED; ALL MATERIALS

Dome head			Countersunk		Small head	
Size mm	Head diameter mm	Height of head mm	Head diameter mm	Height of head mm	Head diameter mm	Height of head mm
<b>M 4</b>	<b>9</b>	<b>0.80</b>	<b>9</b>	<b>1.5 - 1.6</b>	<b>7.1</b>	<b>0.70</b>
<b>M 5</b>	<b>10</b>	<b>1.00</b>	<b>10</b>	<b>1.5 - 1.6</b>	<b>8.1</b>	<b>0.70</b>
<b>M 6</b>	<b>12</b>	<b>1.50</b>	<b>12</b>	<b>1.5 - 1.6</b>	<b>10.1</b>	<b>0.70</b>
<b>M 8</b>	<b>14</b>	<b>1.50</b>	<b>14</b>	<b>1.5 - 1.6</b>	<b>12.1</b>	<b>0.70</b>
<b>M 10</b>	<b>15</b>	<b>1.50</b>	<b>15</b>	<b>1.5 - 1.6</b>	<b>13.1</b>	<b>0.70</b>

### SHAFT GEOMETRY HALF HEXAGONAL; ALL MATERIALS

Dome head			Small head	
Size mm	Head diameter mm	Height of head mm	Head diameter mm	Height of head mm
<b>M 4</b>	<b>9</b>	<b>0.80</b>	<b>7.4</b>	<b>0.60</b>
<b>M 5</b>	<b>10</b>	<b>1.00</b>	<b>8.4</b>	<b>0.70</b>
<b>M 6</b>	<b>13</b>	<b>1.50</b>	<b>10.4</b>	<b>0.70</b>
<b>M 8</b>	<b>16</b>	<b>1.50</b>	<b>12.4</b>	<b>0.70</b>





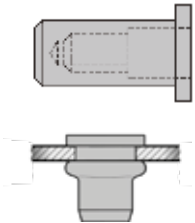

# BLIND RIVET NUTS ALU CLOSED END (CAP®)

Material: AlMg 3

## Standard





Dome head

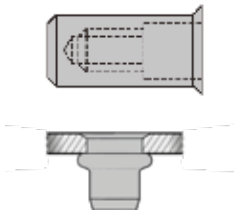

D	D x L mm	 mm	No.	
<b>M 4</b>  6.1 mm	<b>6 x 15.0</b>	0.25 - 3.0	<b>146 4107</b>	A 500
	<b>6 x 17.0</b>	2.5 - 4.5	<b>146 4108</b>	"
<b>M 5</b>  7.1 mm	<b>7 x 17.0</b>	0.25 - 3.0	<b>146 4109</b>	A 500
	<b>7 x 19.0</b>	2.5 - 5.0	<b>146 4110</b>	A 250
<b>M 6</b>  9.1 mm	<b>9 x 21.5</b>	0.25 - 3.5	<b>146 4111</b>	A 100
	<b>9 x 24.5</b>	3.0 - 5.5	<b>146 4112</b>	"
<b>M 8</b>  11.1 mm	<b>11 x 24.0</b>	0.25 - 3.5	<b>146 4113</b>	A 100
	<b>11 x 27.0</b>	3.0 - 6.0	<b>146 4114</b>	"

## Small head







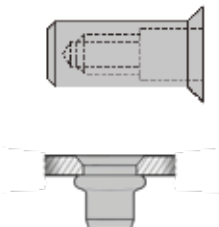

D	D x L mm	 mm	No.	
<b>M 4</b>  6.1 mm	<b>6 x 16.0</b>	0.25 - 3.0	<b>146 4115</b>	A 500
	<b>M 5</b>  7.1 mm	0.25 - 3.0	<b>146 4116</b>	A 500
<b>M 6</b>  9.1 mm	<b>9 x 21.5</b>	0.25 - 3.5	<b>146 4117</b>	A 250

## Countersunk

(90°)



D	D x L mm	 mm	No.	
<b>M 4</b>  6.1 mm	<b>6 x 16.0</b>	1.5 - 3.0	<b>146 4099</b>	A 500
	<b>6 x 17.5</b>	3.0 - 5.0	<b>146 4100</b>	"
<b>M 5</b>  7.1 mm	<b>7 x 19.0</b>	1.5 - 4.0	<b>146 4101</b>	A 250
	<b>7 x 21.0</b>	3.5 - 6.0	<b>146 4102</b>	"
<b>M 6</b>  9.1 mm	<b>9 x 23.0</b>	1.5 - 4.5	<b>146 4103</b>	A 100
	<b>9 x 25.0</b>	4.0 - 6.5	<b>146 4104</b>	"
<b>M 8</b>  11.1 mm	<b>11 x 25.5</b>	1.5 - 4.5	<b>146 4105</b>	A 100
	<b>11 x 27.5</b>	4.0 - 6.5	<b>146 4106</b>	"



174





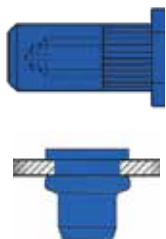

The maximum tightening torque and the threaded breaking force and shear strengths for all blind rivet nuts can be found on **page 174**. For head diameters, please report to **page 185**.

# BLIND RIVET NUTS STEEL CLOSED END (CAP®)

Material: Steel, zinc-plated





## Standard Dome head

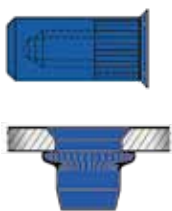

D	D x L mm	 mm	No.	
<b>M 4</b>  6.1 mm	<b>6 x 15.0</b>	0.25 - 3.0	<b>143 2370</b>	A 500
	<b>6 x 17.0</b>	2.5 - 4.5	<b>143 2369</b>	"
<b>M 5</b>  7.1 mm	<b>7 x 17.0</b>	0.25 - 3.0	<b>143 2373</b>	A 500
	<b>7 x 19.0</b>	2.5 - 5.0	<b>143 2374</b>	"
<b>M 6</b>  9.1 mm	<b>9 x 21.5</b>	0.25 - 3.5	<b>143 2375</b>	A 100
	<b>9 x 24.5</b>	3.0 - 5.5	<b>143 2376</b>	"
<b>M 8</b>  11.1 mm	<b>11 x 24.0</b>	0.25 - 3.0	<b>143 2377</b>	A 100
	<b>11 x 27.0</b>	3.0 - 6.0	<b>143 2378</b>	"







## Small head

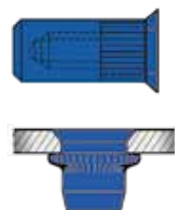

D	D x L mm	 mm	No.	
<b>M 4</b>  6.1 mm	<b>6 x 16.0</b>	0.25 - 3.0	<b>146 4295</b>	A 500
<b>M 5</b>  7.1 mm	<b>7 x 18.0</b>	0.25 - 3.0	<b>146 4294</b>	A 250
<b>M 6</b>  9.1 mm	<b>9 x 21.5</b>	0.25 - 3.5	<b>146 4293</b>	A 100

## Countersunk (90°)



D	D x L mm	 mm	No.	
<b>M 4</b>  6.1 mm	<b>6 x 16.0</b>	1.5 - 3.0	<b>143 2379</b>	A 500
	<b>6 x 17.5</b>	3.0 - 5.0	<b>143 2380</b>	"
<b>M 5</b>  7.1 mm	<b>7 x 19.0</b>	1.5 - 4.0	<b>143 2381</b>	A 250
	<b>7 x 21.0</b>	3.5 - 6.0	<b>143 2382</b>	"
<b>M 6</b>  9.1 mm	<b>9 x 23.0</b>	1.5 - 4.5	<b>143 2383</b>	A 100
	<b>9 x 25.0</b>	4.0 - 6.5	<b>143 2385</b>	"
<b>M 8</b>  11.1 mm	<b>11 x 25.5</b>	1.5 - 4.5	<b>146 4297</b>	A 100
	<b>11 x 27.5</b>	4.0 - 6.5	<b>146 4296</b>	"



**174**

The maximum tightening torque and the threaded breaking force and shear strengths for all blind rivet nuts can be found on **page 174**. For head diameters, please report to **page 185**.

# BLIND RIVET NUT LIGHT WEIGHT\*

NEW

Blind rivet nut Light Weight –  
When every gram counts!  
Light. Compact. Strong

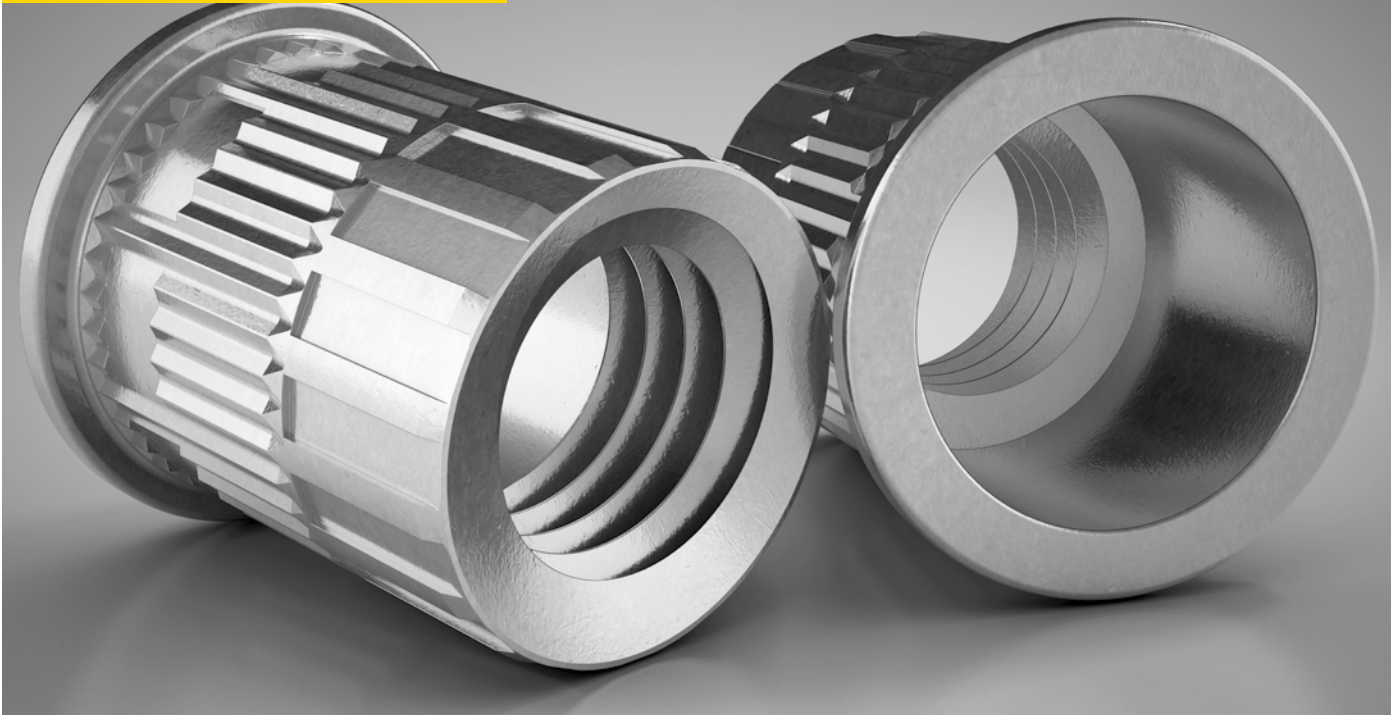

## LIGHT WEIGHT BLIND RIVET NUT

The new blind rivet nut light weight is the next evolutionary step at the blind rivet technology. This blind rivet nut focus and supports the trends at all industry sectors, which are weight reduction and save of resources.

The blind rivet nut light weight can save up to 50% weight by optimising of material and design and has the equal mechanical characteristics at the same time.

## ADVANTAGES

- Weight savings up to 50%
- Less space required (on the blind side)
- Mechanical characteristics equal or better compared to standard blind rivet nuts
- Fast process
- Process control available
- No refinishing operations required
- No third material (glue)
- No aging issues
- Oneside access

\*GESIPA® Light Weight® is protected by the U.S. Pat. 10,648,500



5 STANDARD  
BLIND RIVET NUTS  
**21.3 g**







10 LIGHT WEIGHT  
BLIND RIVET NUTS  
**20.6 g**

# BLIND RIVET NUT LIGHT WEIGHT Material: Steel, zinc-plated





## Steel splined Standard Dome head

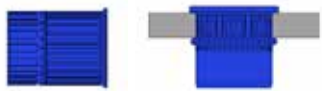

D	D x L mm	 mm	No.	
<b>M 5</b>  7.1 mm + 0.1mm	<b>7 x 9.5</b>	0.5 - 3.0	<b>165 8768</b>	A 500
<b>M 6</b>  9.1 mm + 0.1mm	<b>9 x 10.5</b>	0.5-3.5	<b>165 8766</b>	A 250

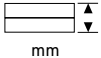
## Steel splined Small head



D	D x L mm	 mm	No.	
<b>M 5</b>  7.1 mm + 0.1mm	<b>7 x 9.5</b>	0.5 - 3.0	<b>165 8769</b>	A 500
<b>M 6</b>  9.1 mm + 0.1mm	<b>9 x 10.5</b>	0.5 - 3.5	<b>165 8767</b>	A 250



### THE TIGHTENING TORQUE (NM) AND (LB-FT)

	Steel	
	Nm	(lb-ft)
<b>M5</b>	<b>8.0</b>	5.9
<b>M6</b>	<b>12.0</b>	8.9

### THREAD BREAKING FORCE (N) AND (KP)

	Steel	
	N	(kp)
<b>M5</b>	<b>11,500</b>	1,172
<b>M6</b>	<b>18,000</b>	1,836

### SHAFT GEOMETRY ROUND AND SPLINED; ALL MATERIALS

Size mm	Dome head		Countersunk		Small head	
	Head diameter mm	Height of head mm	Head diameter mm	Height of head mm	Head diameter mm	Height of head mm
<b>M 5</b>	10	1.00	10	1.5 - 1.6	8.1	0.70
<b>M 6</b>	12	1.50	12	1.5 - 1.6	10.1	0.70

# BLIND RIVET NUT HIGH STRENGTH



## HIGH-STRENGTH BLIND RIVET NUT

The new high-strength blind rivet nut is the ideal choice for all applications where a particularly strong thread is required. The thread-breaking strength far exceeds that of a standard blind rivet nut and the half-hexagonal shank provides the appropriate anti-twist protection.

## AREAS OF APPLICATION

- Perfectly suited for high-load applications in shell construction
- Structural components (e.g. safety components, etc.)

## STRENGTH

- 10.9 or 12.9 for steel blind rivet nut
- 10.9 for steel blind rivet stud
- 8.8 for aluminium blind rivet nut

## ADVANTAGES

- Quick assembly with access from only one side
- A solution for high-load applications
- Process monitoring possible
- Mechanical properties are significantly higher than those of standard steel blind rivet nuts
- Optimises the connections for different applications (e.g. weight reduction)
- Can be combined with customer-specific requirements and other GESIPA® innovations

Further information on the new products can be obtained from product management. Please contact us!

# BLIND RIVET NUT TORQUE RESISTANT



## BLIND RIVET NUT TORQUE RESISTANT

The new torque-resistant blind rivet nut is the perfect solution when it comes to inserting threaded elements into aluminium profiles, with access only required from one side. According to the current state of the art, the rivet nut achieves mechanical properties that would otherwise only be possible when using hexagonal blind rivet nuts.

## APPLICATIONS

Aluminium extruded profiles with one-side access to the riveting position:

- Girder/side rail
- Safety systems
- Profile Structures

## PRODUCT PORTFOLIO

- Blind Rivet Nut Steel M6 with wedges under the head
- Blind Rivet Nut Steel M8 with wedges under the head
- Blind Rivet Nut Steel M10 with wedges under the head

## ADVANTAGES

- **PROCESS RELIABILITY**  
Increased Torque Resistance during the assembly process
- **FAST**  
Reduction of the costs and the process time per assembly
- **CUSTOMIZED**  
Different plating is possible depending on corrosion requirements
- **COMPATIBLE WITH COMPLETE GESIPA® SYSTEMS**  
Joint integrity control possible with process control
- **ECONOMIC**  
Increasing of the economy in comparison to a hexagonal blind rivet nut



# BLIND RIVET NUT G-SEALED®

The new blind rivet nut with pre-coating is especially durable

NEW



## BLIND RIVET NUT G-SEALED®

G-Sealed® is a nonreactive coating that can be applied to create an under head seal to blind rivet nuts, blind rivet nut studs & blind rivets.

## APPLICATIONS

G-Sealed® can be used in many areas of application but is especially suited to the automotive industry due to its excellent thermal & chemical resistance.







## ADVANTAGES

- Non-reactive and non-hardening coating
- Instant sealing as soon as the fastener is installed
- A dry, elastic, non-slip coating
- Good thermal and chemical resistance
- Applicable for metallic and non-metallic materials
- No markings and therefore not dangerous or harmful to the environment

## Standard with G-Sealed®

Dome head



D	D x L mm	 mm	No.	
<b>M 4</b>  6.1 mm	<b>6 x 15.0</b>	0.25 - 3.0	<b>166 6799</b>	A 500
<b>M 5</b>  7.1 mm	<b>7 x 17.0</b>	0.25 - 3.0	<b>166 6800</b>	A 500
<b>M 6</b>  9.1 mm	<b>9 x 21.5</b>	0.25 - 3.5	<b>166 6801</b>	A 100
<b>M 8</b>  11.1 mm	<b>11 x 24.0</b>	0.25 - 3.0	<b>166 6802</b>	A 100

Other dimensions on request.



# POLYGRIP® BLIND RIVET NUTS

The GESIPA® blind rivet nuts with a large grip range



## THE POLYGRIP® BLIND RIVET NUTS

Die PolyGrip® blind rivet nuts are the logical further development of many years of experience with our PolyGrip® multi-range blind rivets. Thanks to the benefits of its large drilling hole tolerance and the option of covering various grip ranges with just one fastener, the PolyGrip® blind rivet nut has become a first-choice connector in many industrial applications and in trade.

Bringing together multiple dimensions saves handling and storage costs while also permanently reducing the risk of confusion in the workplace and the quality problems this can result in.

**LARGE GRIP RANGE:** Ideally, the one PolyGrip® blind rivet nut can replace up to five different dimensions of DIN standard blind rivet nuts thanks to the large grip range.

### Your benefits:

- Type simplification
- Limited type variety for reduced stocks
- Lower risk of confusion therefore fewer mistakes in production

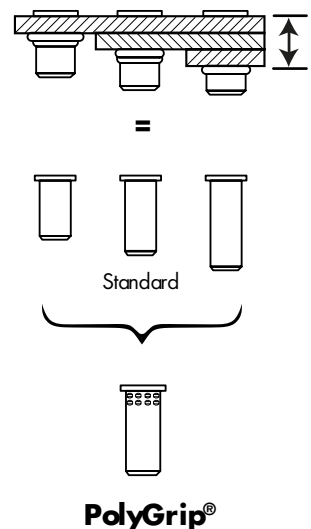

6



The best setting results can be achieved with GESIPA® FireBird® Pro!



# POLYGRIP® BLIND RIVET NUTS

## Aluminium Standard

Dome head

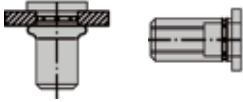

Material: AlMg 2.5



D	D x L mm	 mm	No.	
<b>M 5</b>  7.1 mm	<b>7 x 13.5</b>	0.25 - 5.0	<b>143 3791</b>	A 500
<b>M 6</b>  9.1 mm	<b>9 x 18.0</b>	0.25 - 6.0	<b>143 3792</b>	A 250
<b>M 8</b>  11.1 mm	<b>11 x 20.0</b>	0.5 - 6.5	<b>145 5561</b>	A 100

## Steel Standard

Dome head

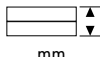

Material: Steel Surface: Zinc-plated

D	D x L mm	 mm	No.	
<b>M 5</b>  7.1 mm	<b>7 x 13.5</b>	0.25 - 5.0	<b>143 3793</b>	A 500
<b>M 6</b>  9.1 mm	<b>9 x 18.0</b>	0.25 - 6.0	<b>143 3794</b>	A 250
<b>M 8</b>  11.1 mm	<b>11 x 20.0</b>	0.5 - 6.5	<b>143 3795</b>	A 100

## Stainless Steel A2 Standard

Dome head

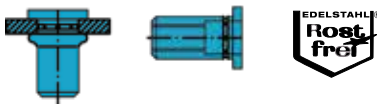

Material: Stainless Steel A2 1.4567, polished

D	D x L mm	 mm	No.	
<b>M 5</b>  7.1 mm	<b>7 x 13.5</b>	0.25 - 5.0	<b>143 3796</b>	A 500
<b>M 6</b>  9.1 mm	<b>9 x 18.0</b>	0.5 - 6.0	<b>143 3797</b>	A 250
<b>M 8</b>  11.1 mm	<b>11 x 20.0</b>	0.5 - 6.5	<b>143 3798</b>	A 100

Material surcharge will be added at a daily rate.

## Stainless Steel A4 Standard

Dome head

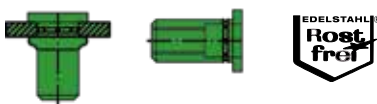

Material: Stainless Steel A4 1.4578, polished

D	D x L mm	 mm	No.	
<b>M 5</b>  7.1 mm	<b>7 x 13.5</b>	0.25 - 5.0	<b>145 0393</b>	A 500
<b>M 6</b>  9.1 mm	<b>9 x 18.0</b>	0.5 - 6.0	<b>145 5567</b>	A 250
<b>M 8</b>  11.1 mm	<b>11 x 20.0</b>	0.5 - 6.5	<b>145 5568</b>	A 100

Material surcharge will be added at a daily rate.



The maximum tightening torque and the threaded breaking force and shear strengths for all blind rivet nuts can be found on **page 174**. For head diameters, please report to **page 185**.

# POLYGRIP® BLIND RIVET NUTS SPLINED

**Splined multi-range blind rivet nuts for improved anti-twist protection in soft materials**



The new GESIPA® splined PolyGrip® blind rivet nuts made from M6 and M8 steel are a further development of the well-proven PolyGrip® multi-range blind rivet nuts. They combine the advantages of covering large grip ranges with the knurling for increased anti-twist protection.

The long longitudinal knurling ensures uniform setting characteristics over the entire grip range and a large closing head.

In the ideal case, the splined PolyGrip® blind rivet nut can replace up to 5 different standard DIN dimensions. This saves handling and storage costs while also reducing the risk of confusion in the workplace.

## Steel Standard

Dome head

Material: Steel  
Surface: galvanised

D	D x L mm	 mm	No.	
<b>M 6</b>  9.1 mm	<b>9 x 18.0</b>	0.5 - 6.5	<b>145 5562</b>	A 250
<b>M 8</b>  11.1 mm	<b>11 x 20.0</b>	0.5 - 8.0	<b>145 5563</b>	A 100



The best setting results can be achieved with GESIPA® FireBird® Pro!  
**page 216**

# SOFTGRIP® BLIND RIVET NUTS

SoftGrip® blind rivet nuts from GESIPA® make it easy to produce high-quality threads in sensitive lightweight applications



Carbon fibre-reinforced plastics (CFRP) offer indisputable and fascinating advantages when it comes to saving weight. They are, however, particularly demanding when selecting the partner material. Standard joining elements simply will not do for this high-grade material. GESIPA® has now developed a blind rivet nut for composite materials that meets the demanding requirements.

The SoftGrip® blind rivet nut from GESIPA® is a further development of the tried and tested PolyGrip® multi-range blind rivet nut. With the aid of a precisely controlled setting procedure, the component is barely subjected to bearing stress and contact pressure. The bulb that forms flat on the component with a large (larger than average) diameter ensures outstanding mechanical properties. Component damage such as crushing, cracking, delamination etc. are therefore effectively avoided.

Thanks to the controlled formation of the bulb and the thus reduced bearing stress, minimal edge spacing of the blind rivet nut can be realised in connection with large hole tolerances. The use of high-grade stainless steel A2 materials (A4 on request) additionally makes the load bearing thread highly resistant to corrosion.

## ADVANTAGES

- Fast processes
- Tight fit with the components
- Process monitoring and process control are possible
- High strength
- Not dependent on surface properties
- No other materials required (adhesive)
- No ageing
- Accessible from one side
- No delamination of the CFRP
- Smaller edge spacing of the holes
- Large grip range
- Stainless steel for high corrosion resistance
- Higher hole drilling tolerances

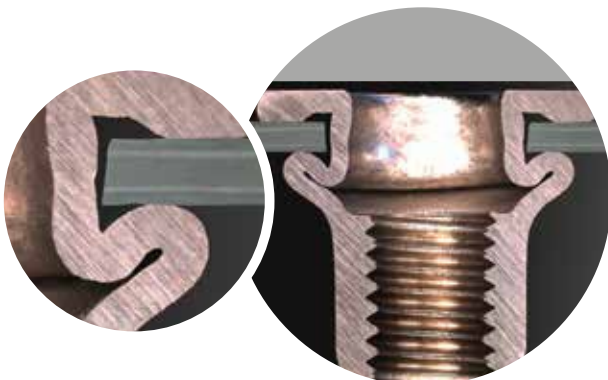

### Perfect for plastics and soft materials





As a cost-effective alternative to the stainless steel SoftGrip®, the SoftGrip® steel blind rivet nut is the ideal functional component for plastics and soft materials where there is no need to prevent contact corrosion.

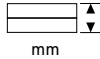

### Steel Standard

Dome head



D	D x L mm	 mm	No.	
<b>M 6 - K 13</b>  9.1 mm	<b>9 x 20.0</b>	0.5 - 4.5	<b>156 8810</b>	A 100
	<b>9 x 20.0</b>	4.5 - 6.5	<b>156 8811</b>	A 100
<b>M 6 - K 16</b>  9.1 mm	<b>9 x 20.0</b>	0.5 - 4.5	<b>156 8874</b>	A 100
	<b>9 x 20.0</b>	4.5 - 6.5	<b>156 8875</b>	A 100
<b>M 6 - K 18</b>  9.1 mm	<b>9 x 20.0</b>	0.5 - 4.5	<b>156 8878</b>	A 100
	<b>9 x 20.0</b>	4.5 - 6.5	<b>156 8879</b>	A 100

The standard SoftGrip® can be adapted in accordance with special requirements and specific customer requests in many areas. Other dimensions available on request.

### Ideal for CFRP applications





The high-quality materials stainless A2 and A4 also ensure that the load-bearing thread is highly resistant to corrosion, making the GESIPA® SoftGrip® stainless steel blind rivet nut ideal for use with CFRP materials.

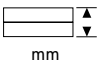

### Stainless Steel A2 Standard

Dome head







D	D x L mm	 mm	No.	
<b>M 6 - K 16</b>  9.1 mm	<b>9 x 20.0</b>	0.5 - 4.5	<b>152 3786</b>	A 100
	<b>9 x 20.0</b>	4.5 - 6.5	<b>152 3787</b>	A 100
<b>M 6 - K 18</b>  9.1 mm	<b>9 x 20.0</b>	0.5 - 4.5	<b>156 7589</b>	A 100
	<b>9 x 20.0</b>	4.5 - 6.5	<b>156 8804</b>	A 100

### Stainless Steel A4 Standard

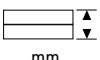
Dome head



D	D x L mm	 mm	No.	
<b>M 6 - K 16</b>  9.1 mm	<b>9 x 20.0</b>	0.5 - 4.5	<b>156 8805</b>	A 100
	<b>9 x 20.0</b>	4.5 - 6.5	<b>156 8806</b>	A 100
<b>M 6 - K 18</b>  9.1 mm	<b>9 x 20.0</b>	0.5 - 4.5	<b>156 8807</b>	A 100
	<b>9 x 20.0</b>	4.5 - 6.5	<b>156 8808</b>	A 100

Material surcharge will be added at a daily rate.

# BLIND RIVET NUT STUDS

Combination of blind rivet nut and stud as an alternative or replacement for welding studs and press-in studs



As a combination of blind rivet nut and screw, blind rivet nut studs offer a technical as well as cost-effective alternative to welding studs or other multi-piece T-slot systems. The blind rivet nut stud has two functions. On the one hand, it joins thin materials even if they are different. On the other hand, with the reliably and permanently fixed screw it provides an additional fastening point or a positioning aid. Different dimensions, materials and head shapes cover a wide range of applications. In addition to the standard range, application-specific applications are possible.

## ADVANTAGES

- Dual function: Joining materials and providing additional fastening point (threaded stud)
- Access only required from one side
- High load bearing capacity of thread
- Simple, neat and fast processing
- Space-saving
- No damage to painted surfaces
- No heat transfer, i.e. no change in material structure
- Suitable for repairing welding studs

## APPLICATIONS

The following applications are particularly suitable for the use of GESIPA® blind rivet nut studs:

- Accessible from one side
- Thin carrier materials such as sheet metal, plastics, etc.
- Pre-centring required
- Heat transfer, e.g. welding joined materials not possible or permitted
- Surface coatings must not be damaged
- Making electrically conductive joints
- Fast repairs of welding studs

GESIPA® blind rivet nut studs can be set without any problems with the GESIPA® blind rivet nut setting tools FireBird®, GBM 95 and FireFox® using corresponding adapters for blind rivet nut studs (see tool description).

# BLIND RIVET NUT STUDS STEEL

## Steel Standard

Dome head

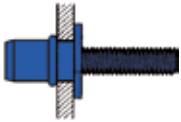

Material: Steel, zinc-plated

D	D x L mm	 mm	Thread protrusion min. mm	No.	
<b>M 4</b> 6.1 mm	<b>6 x 11.0</b>	0.25 - 3.0	10.0	<b>143 3665</b>	A 200
<b>M 5</b> 7.1 mm	<b>7 x 11.5</b>	0.25 - 3.0	11.5	<b>145 5330</b>	A 150
<b>M 6</b> 9.1 mm	<b>9 x 15.5</b>	0.25 - 3.0	13	<b>145 5331</b>	A 100
<b>M 8</b> 11.1 mm	<b>11 x 17.0</b>	0.25 - 3.0	15.5	<b>145 5332</b>	A 100

## Steel half hexagonal Standard



Material: Steel, zinc-plated

D	D x L mm	 mm	Thread protrusion min. mm	No.	
<b>M 4</b> SW6 + 0.1 mm	<b>6 x 11.0</b>	0.5 - 2.0	10.0	<b>145 0359</b>	A 200
<b>M 5</b> SW7 + 0.1 mm	<b>7 x 12</b>	0.5 - 3.0	11.5	<b>145 0360</b>	A 150
<b>M 6</b> SW9 + 0.1 mm	<b>9 x 15.5</b>	0.5 - 3.0	13	<b>145 0361</b>	A 100
<b>M 8</b> SW11 + 0.1 mm	<b>11 x 17.0</b>	0.5 - 3.0	15.5	<b>145 0362</b>	A 50

Size mm	N (kp)	N (kp)	Max. torque Nm
<b>M 4</b>	<b>5,160</b> (525)	<b>6,030</b> (614)	<b>3.0</b>
<b>M 5</b>	<b>7,200</b> (733)	<b>10,800</b> (1,100)	<b>6.0</b>
<b>M 6</b>	<b>10,800</b> (1,100)	<b>17,800</b> (1,812)	<b>13.0</b>
<b>M 8</b>	<b>18,400</b> (1,873)	<b>27,800</b> (2,830)	<b>26.0</b>

The values were determined using a screw of the strength class 8.8.

Further dimensions, special surface treatments or materials are available on request.

### SHAFT GEOMETRY ROUND AND SPLINED; ALL MATERIALS

Dome head		
Size mm	Head diameter mm	Height of head mm
<b>M 4</b>	9	0.80
<b>M 5</b>	10	1.00
<b>M 6</b>	12	1.50
<b>M 8</b>	14	1.50

### SHAFT GEOMETRY HALF HEXAGONAL; ALL MATERIALS

Dome head		
Size mm	Head diameter mm	Height of head mm
<b>M 4</b>	9	0.80
<b>M 5</b>	10	1.00
<b>M 6</b>	13	1.50
<b>M 8</b>	16	1.50

# POLYGRIP® BLIND RIVET NUT STUDS SPLINED

**Splined multi-range blind rivet nut studs for improved anti-twist protection in soft materials**



The new GESIPA® splined PolyGrip® blind rivet nut studs made from M6 and M8 steel are a further development of the well-proven PolyGrip® multi-range blind rivet nuts. They combine the advantages of covering large grip ranges with the knurling for increased anti-twist protection.





The long longitudinal knurling ensures uniform setting characteristics over the entire grip range and a large closing head.

In the ideal case, the splined PolyGrip® blind rivet nut studs can replace up to 5 different standard DIN dimensions. This saves handling and storage costs while also reducing the risk of confusion in the workplace.

## Steel Standard

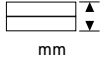
Dome head



D	D x L mm	 mm	Thread protrusion min. mm	No.	
<b>M 6</b>  9.1 mm	<b>9 x 18.0</b>	0.5 - 6.0	13	<b>146 4481</b>	A 100
<b>M 8</b>  11.1 mm	<b>11 x 20.0</b>	0.5 - 8.0	15.5	<b>146 4480</b>	A 50

Material: Steel Surface: galvanised



The best setting results can be achieved with GESIPA® FireBird® Pro!





# BLIND RIVET NUTS with hose connection

Especially for pneumatic plastic hoses



## SPECIFICATION

BRN M5x7x26 KK steel,  
hose connection, galvanized

## GRIP RANGE

0.50 - 2.50 mm

## PREDRILLED HOLE Ø

7.1 + 0.1 mm

## USE

Connection of a pneumatic hose  
(ø 4 mm) for use with liquids and gases

## CUSTOMER ADVANTAGES

- Reduction in variety of parts
- Better look (single colour)
- Reduced assembly effort
- Simplified assembly process
- Access to component from one side
- Saving on material and assembly costs

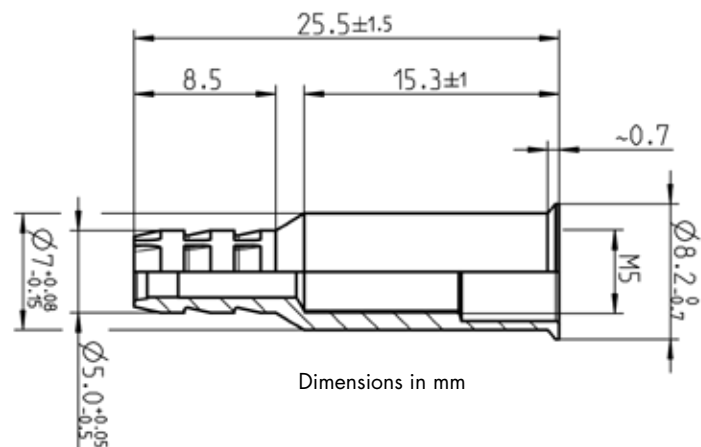

## SECTORS

- Ventilation and air conditioning technology
- Pneumatics accessories
- Housing and container manufacturing

No. 145 5364



Example: Blind rivet nut with plastic hose

# CORDLESS BLIND RIVET NUT SETTING TOOLS

Cordless blind rivet nut setting tool from GESIPA® - Easy to operate, tried and tested, and simply good!



## BLIND RIVET NUT HAND TOOLS



204



205

GBM 10



207

GBM 40-R



208

GBM 50



209

FireFly



211

Flipper® Plus

# Cordless blind rivet nut setting tools

## BATTERY-POWERED BLIND RIVET NUT SETTING

214



FireBird® Pro



FireBird® Pro Gold Edition



FireBird® Pro S Gold Edition



FireBird®



FireBird® with conversion kit for blind rivet nut studs

## WHAT RIVETS WHAT?

Tool	Type	Rivet Size							Material
		M3	M4	M5	M6	M8	M10	M12	
GBM 10	H	●	●	●	A				BNM Light Weight, BNM High Strength, BNM Torque resistant BNM PolyGrip®
GBM 40-R	H	●	●	●	●	●	AS	●	
GBM 50	H	●	●	●	●	●	AS	●	
FireFly	H	●	●	AS	A				
Flipper® Plus	H		AS	AS	A				
FireBird®, FireBird® Pro	B	●	●	●	●	AS	A	●	
FireBird® Pro Gold Edition / FireBird® Pro S Gold Edition	B	●	●	●	●	●	AS	●	

- H:** Hand tool
- B:** Battery-powered tool
- A:** Alu/Copper
- S:** Steel
- E:** Stainless Steel

**Blue box:** All materials (ASE) can be riveted. Where there are exceptions, the letters of the rivetable materials are provided directly in the box.

7

## **BLIND RIVET NUT HAND TOOLS**

**GESIPA® manual blind rivet nut setting tools – Easy to operate, tried and tested, always good but now even better!**



# GBM 10

**Manual blind rivet  
nut setting tool  
with simple stroke  
setting**

**GBM 10 – M4  
No. 145 7087**

**GBM 10 – M5  
No. 143 4761**

**GBM 10 – M6  
No. 145 7088**

## TECHNICAL DATA

Weight: 600 g  
Total length: 260 mm  
Stroke: 7 mm

## WORKING RANGE

Blind rivet nuts from M3 up to M6 alu  
and up to M5 steel, brass and stainless steel  
*The blind rivet nuts Light Weight, High Strength  
and Torque Resistant can not be processed!*

## SCOPE OF DELIVERY

Standard: Threaded mandrel and nosepiece  
(optional M4 - M6)  
Maintenance instructions with spare parts list  
Stroke table

## ADVANTAGES

- Simple lift setting via a knurled nut for safe and complete setting of the blind rivet nuts
- Threaded mandrel protection via spring ring for fast tool-free replacement of the threaded mandrel
- With opening spring for simple handling
- Body in high-quality die cast aluminium
- Body head made of forged chrome-vanadium steel
- Ergonomic handles

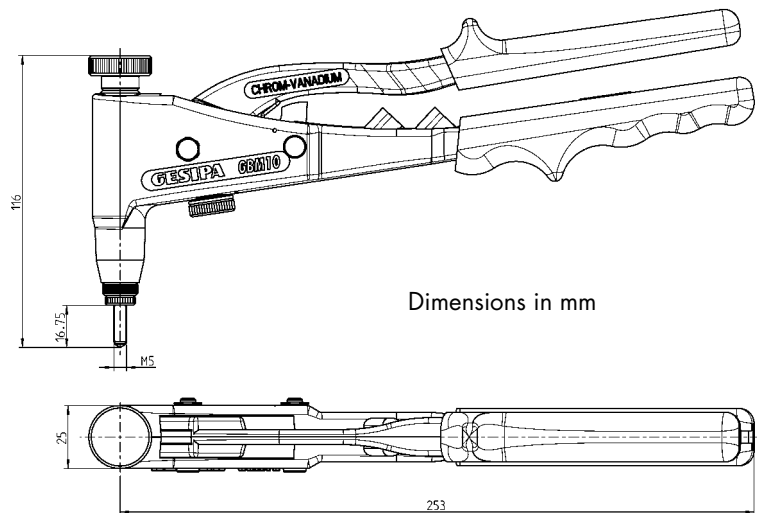

## Housing

Improved performance thanks to newly designed housing



## Surface

Powder-coated abrasion-resistant housing surface in GESIPA® colour

## Ergonomics

Ergonomically formed handles for working efficiently without fatigue

# SPECIAL ACCESSORIES GBM 10

## THREADED MANDRELS AND NOSEPIECES for GBM 10

### THREADED MANDRELS

Threaded mandrels	No.
Threaded mandrels M3*	<b>145 7096</b>
Threaded mandrels M4	<b>143 4776</b>
Threaded mandrels M5	<b>143 4779</b>
Threaded mandrels M6	<b>143 4781</b>
Threaded mandrels 8-32 UNC	<b>143 4784*</b>
Threaded mandrels 10-24	<b>145 7098*</b>
Threaded mandrels 10-32 UNF	<b>143 4783*</b>
Threaded mandrels 1/4"-20	<b>143 4785*</b>

### NOSEPIECES

nosepieces	No.
nosepieces M3*	<b>145 7095</b>
nosepieces M4/8-32 UNC	<b>143 4777</b>
nosepieces M5/10-24 UNC**	<b>143 4780</b>
nosepieces M6/ 1/4"-20 UNC	<b>143 4782</b>

\* Available as special accessories

\*\* The 10-24 UNC nosepiece can be used for the 10-24 UNC and 10-32 UNF threaded mandrels.

### BLIND RIVET NUT BOX

GBM 10 with threaded mandrel and nosepiece M5 including threaded mandrels and nosepieces M4 and M 6, different blind rivet nut dimensions M4 to M 6 made of alu for joint thicknesses of 0.25 to 3 mm.

**No. 143 5455**

#### Incl. 4 blind rivet nut sizes:

Alu M4 x 6 x 11.0 mm

Alu M5 x 7 x 11.5 mm

Alu M5 x 7 x 13.5 mm

Alu M6 x 9 x 15.5 mm



# GBM 40-R

The new ratchet tool for setting blind rivet nuts

No. 161 9731

## TECHNICAL DATA

Weight: 1.25 kg  
Total length: 212 mm

## WORKING RANGE

Blind rivet nuts range M3 up to M10 of all materials and M12 aluminium and steel

## SCOPE OF DELIVERY

Threaded mandrel and nosepiece:  
M5, M6, M8 and M10  
1 construction wrench  
Maintenance instructions with spare parts list  
Plastic carrying case

## ADVANTAGES

- The ratchet mechanism enables you to work with extremely low manual force
- Tool-free replacement of threaded mandrel and nosepiece
- Nosepieces and threaded mandrels compatible with GBM 50
- Can be converted for setting blind rivet studs

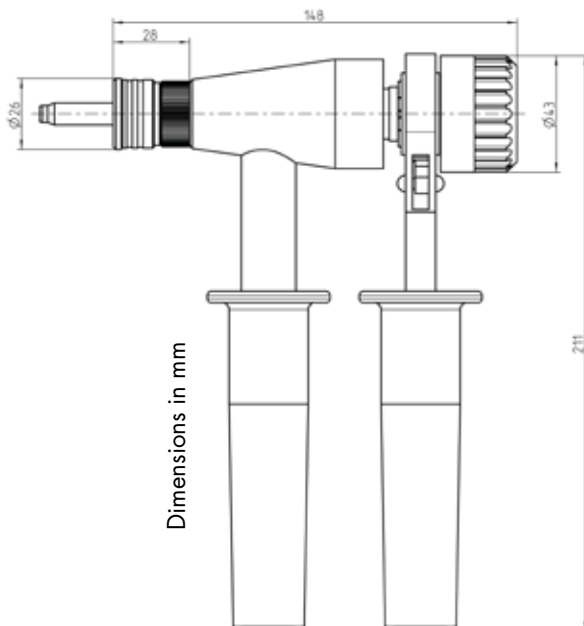

Also suitable for blind rivet studs.  
Conversion possible!



## NOSEPIECES AND THREADED MANDRELS

nosepieces	No.	threaded mandrels	No.
M3*	<b>162 6929</b>	M3*	<b>162 6916</b>
M4*	<b>162 6941</b>	M4*	<b>162 6917</b>
M5	<b>162 2548</b>	M5	<b>162 2543</b>
M6	<b>162 2549</b>	M6	<b>162 2544</b>
M8	<b>162 2552</b>	M6 SL 10* <sup>2</sup>	<b>167 8754</b>
M8 SL 30*	<b>166 4686</b>	M8	<b>162 2545</b>
M10	<b>162 2553</b>	M8 SL 10* <sup>2</sup>	<b>167 8755</b>
M12*	<b>162 2554</b>	M8 SL 30*	<b>166 4684</b>
		M10	<b>162 2546</b>
		M12*	<b>162 2547</b>



**SL 30 special length:**  
Extended nosepiece and threaded mandrel for difficult-to-access and/or deep-seated applications.

\* Available as special accessories.  
Other dimensions on request.  
\*<sup>2</sup> from a blind rivet nut length of 21 mm for M6 and M8, the threaded mandrels SL 10 must be used

## CONVERSION KIT for blind rivet studs

Description	No.
M4	<b>162 2556</b>
M5	<b>162 2557</b>
M6	<b>162 2558</b>
M8	<b>162 2560</b>

# GBM 50

**Blind rivet nut hand setting tools with quick drill system**



**No. 161 9730**

Also suitable for blind rivet nut studs. Conversion possible!

## TECHNICAL DATA

Weight: 2.4 kg  
Total length: 485 mm

## WORKING RANGE

Blind rivet nuts range M3 up to M10 of all materials and M12 aluminium and steel

## SCOPE OF DELIVERY

Threaded mandrel and nosepiece::  
M5, M6, M8 and M10  
1 construction wrench  
Maintenance instructions with spare parts list  
Plastic carrying case

## ADVANTAGES

- Quick drill system for drilling the threaded mandrel in and out quickly and easily
- Favourable transmission ratio for low effort even when setting large blind rivet nuts
- Easy stroke setting using adjusting ring with stroke scale for safe and complete installation of the blind rivet nut
- Tool-free replacement of threaded mandrel and nosepiece
- Nosepieces and threaded mandrels compatible with GBM 40-R
- Can be converted for setting blind rivet studs

## THREADED MANDRELS AND NOSEPIECES

nosepieces	No.	threaded mandrels	No.
M3*	<b>162 6929</b>	M3*	<b>162 6916</b>
M4*	<b>162 6941</b>	M4*	<b>162 6917</b>
M5	<b>162 2548</b>	M5	<b>162 2543</b>
M6	<b>162 2549</b>	M6	<b>162 2544</b>
M8	<b>162 2552</b>	M6 SL 10* <sup>2</sup>	<b>167 8754</b>
M8 SL 30*	<b>166 4686</b>	M8	<b>162 2545</b>
M10	<b>162 2553</b>	M8 SL 10* <sup>2</sup>	<b>167 8755</b>
M12*	<b>162 2554</b>	M8 SL 30*	<b>166 4684</b>
		M10	<b>162 2546</b>
		M12*	<b>162 2547</b>

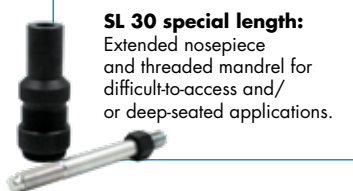

**SL 30 special length:**  
Extended nosepiece and threaded mandrel for difficult-to-access and/or deep-seated applications.

\* Available as special accessories. Other dimensions on request.  
<sup>2</sup>from a blind rivet nut length of 21 mm for M6 and M8, the threaded mandrels SL 10 must be used

## CONVERSION KIT for blind rivet studs

Description	No.	Description	No.
M4	<b>162 2556</b>	M6	<b>162 2558</b>
M5	<b>162 2557</b>	M8	<b>162 2560</b>

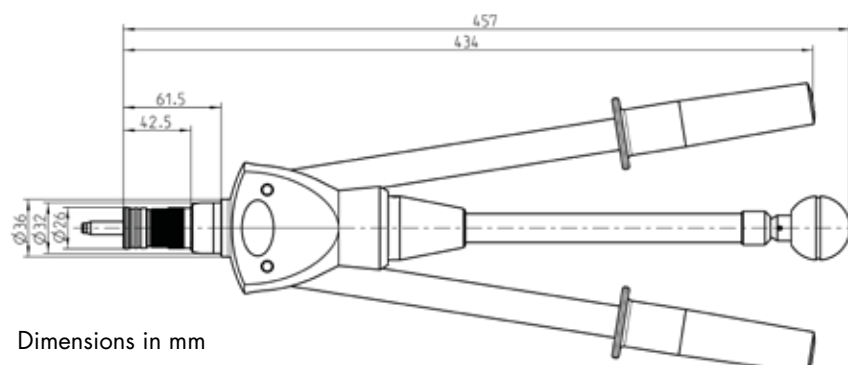

Dimensions in mm



# FIREFLY-BOX

**Force and intelligence for setting blind rivet nuts**

**No. 143 5453**

## TECHNICAL DATA

Total stroke: 9 mm  
Single action stroke: 1.8 mm  
Weight: 750 g

## WORKING RANGE

Blind rivet nuts from M3 up to M6 aluminium as well as from M3 up to M5 steel  
*The blind rivet nuts Light Weight, High Strength and Torque Resistant can not be processed!*

## ADVANTAGES

- The well-proven principle of operation of the GESIPA® hand riveting tool Flipper® spares up to 40% of the hand force for setting blind rivet nuts
- A special lever design as well as the ratchet mechanism provide a reduction of hand force
- Exchange of nosepiece and threaded mandrel
- The total stroke is 9 millimeter long for setting of new generation multigrip blind rivet nuts like new the GESIPA® PolyGrip® blind rivet nuts
- Tool-free setting of stroke and threaded mandrel lengths allows simple setting of blind rivets of different lengths



**210**

The FireFly is also available separately **page 210.**

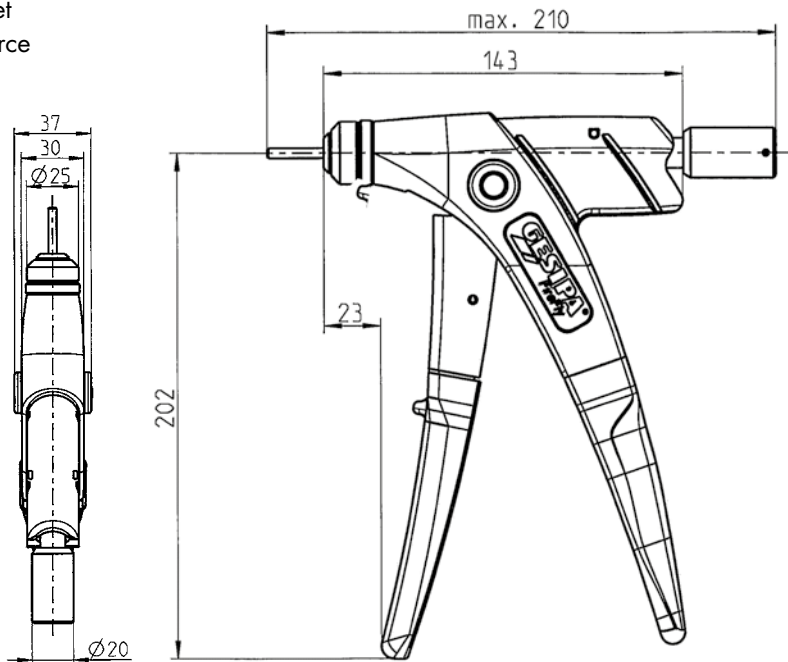

# SPECIAL ACCESSORIES FireFly

## FIREFLY IN CARDBOARD BOX

Equipped with

- Nosepiece
- Threaded mandrel
- Operating instructions and stroke table



TOOL	No.
FireFly M5 in card-board box	<b>143 5454</b>
FireFly M3 in card-board box	<b>145 7653</b>
FireFly M4 in card-board box	<b>145 7654</b>
FireFly M6 in card-board box	<b>145 7655</b>
FireFly 6 - 32 UNC in card-board box	<b>145 7656</b>
FireFly 8 - 32 UNC in card-board box	<b>145 7657</b>
FireFly 10 - 24 UNC in card-board box	<b>145 7658</b>
FireFly 10 - 32 UNF in card-board box	<b>145 7659</b>
FireFly 1/4" - 20 UNC in card-board box	<b>145 7660</b>



## THREADED MANDRELS AND NOSEPIECES

Article	No.
Threaded mandrels M3	<b>143 4002</b>
Threaded mandrels M4	<b>143 4001</b>
Threaded mandrels M5	<b>143 4000</b>
Threaded mandrels M6	<b>143 4008</b>
Nosepiece insert M3	<b>143 3995</b>
Nosepiece insert M4	<b>143 3994</b>
Nosepiece insert M5	<b>143 3993</b>
Nosepiece insert M6	<b>143 3997</b>

Article	No.
Threaded mandrels 6 - 32 UNC	<b>143 4019</b>
Threaded mandrels 8 - 32 UNC	<b>143 4020</b>
Threaded mandrels 10 - 24 UNC	<b>143 4021</b>
Threaded mandrels 10 - 32 UNF	<b>143 4022</b>
Threaded mandrels 1/4" - 20 UNC	<b>143 4023</b>
Nosepiece 6 - 32 UNC	<b>143 4024</b>
Nosepiece 8 - 32 UNC	<b>143 4025</b>
Nosepiece 10 - 24 UNC	<b>143 4026*</b>

\*The nosepiece insert 10 - 24 UNC can be used for threaded mandrels 10- 24 UNC and 10-32 UNF

## REFILL MINI PACKS for blind rivet nuts

M4 x 6 x 13.0

**No. 143 3700**

M5 x 7 x 13.5

**No. 143 3701**

## RETROFIT SET FOR blind rivet nut studs

	No.	BRN thread protrusion	
		min.	max. *
M4	<b>143 4009</b>	8	22
M5	<b>143 4010</b>	9	22
M6	<b>143 4011</b>	10	22

\* A corresponding extended nosepiece must be used for thread protrusions > 22 mm.

# FLIPPER® PLUS combi setting tool

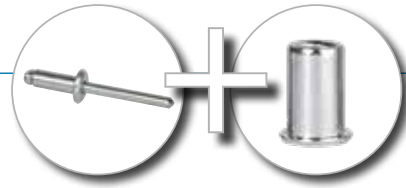

**Virtually tool-free conversion from blind rivet to blind rivet nut setting tool**

**CONVERTED IN UNDER 1 MINUTE IN JUST A FEW SIMPLE STEPS** (page 68)

**No. 157 1258**

## TECHNICAL DATA

Weight:	750 g
Total length:	217 mm
Total stroke:	16.2 mm
Single action stroke:	1.8 mm

## WORKING RANGE BLIND RIVET NUTS

Blind rivet nuts from M4 up to M6 aluminium as well as from M4 up to M5 steel  
*The blind rivet nuts Light Weight, High Strength and Torque Resistant can not be processed!*

## SCOPE OF DELIVERY

Nosepieces: 12/20, 12/24, 12/29, 12/M4, 12/M5 and 12/M6  
 Threaded mandrel conversion kit: M4, M5 and M6  
 1 maintenance wrench, 1 Allen key  
 1 jaw insertion aid  
 Operating instructions with spare parts list

## ADVANTAGES

- New ratchet function
- The force increases when the handle is closed. This finding is put to good use in a special lever arrangement for setting blind rivets and blind rivet nuts: ergonomic design
- The required manual force is reduced by around 40 percent if actuated several times.
- Actuation lever with an opening spring for easy single-handed operation

## ADVANTAGES WHEN SETTING BLIND RIVET NUTS

- The total stroke is 16.2 millimeter long for setting of new generation multigrip blind rivet nuts like the GESIPA® PolyGrip® blind rivet nuts
- Simplified setting procedure for blind rivet nuts



Watch conversion on youtube!

**128** All nosepieces **page 128.**

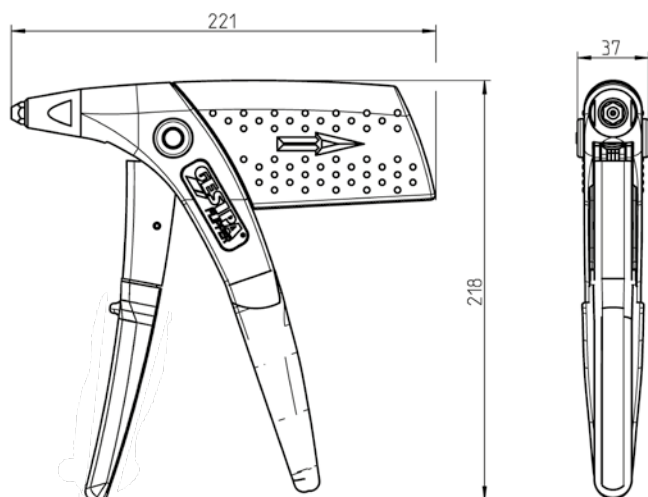

Dimensions in mm

**7**

# BLIND RIVET NUT SETTING TOOLS Battery-powered and hydro-pneumatic tools

## STROKE- OR SETTING-FORCE ADJUSTMENT ?

GESIPA® blind rivet nut setting tools can be controlled through either stroke or setting force. The FireFox® 2 can do both. When which setting should best be used depends on the application, of course. However, what is guaranteed is that the setting options are **SIMPLE, FAST AND SAFE.**

### ADVANTAGES OF SETTING FORCE ADJUSTMENT

- Controlling the tool through setting force adjustment protects material and thread and anchors blind rivet nuts securely in the material
- Quick and easy setting force adjustment via the display or the colour-coded setting ring
- Does not need to be adjusted in case of changing material thicknesses or different lengths of blind rivet nuts

### ADJUSTING SETTING FORCE ON BIRD PRO TOOLS

1. Read the value\* on the setting force guide
2. Enter value\* in the display
3. Set blind rivet nut

(1)

	M3	M4	M5	M6	M8	M10	M12
Alu	1	15	25	55	70	75	90
Stahl	10	35	60	80	85	90	99
Edelstahl	15	55	65	85	95	99	-

Werte dienen nur als Einstellhilfe!  
Data are just an adjustment aid!

(2)



Setting force guide – Example: Steel M5 for FireBird® Pro

(3)



\* The values given are only guide values, because different settings may be required depending on the type of blind rivet nut.

### WHEN IS SETTING FORCE ADJUSTMENT USED?

A blind rivet nut size of the same or varying length (e.g. M6 x 15.5 or M6 x 18) should be set in **changing material** thicknesses using a constant setting force.



### ADJUSTING THE SETTING FORCE ON FIREFOX® TOOLS

When using the setting force adjustment, the maximum tool stroke must be set prior to using the setting force.

#### Presetting the setting force with colour-coded setting ring

Screwing in the set screw increases the tool's setting force, screwing it out reduces the setting force.



Setting force guide FireFox® 2

\* The values given are only guide values, because different settings may be required depending on the type of blind rivet nut.

# DIFFERENCES Stroke- or setting-force adjustment

## ADVANTAGES OF STROKE SETTING

- Controlling the tool through stroke setting guarantees the height of the blind rivet nuts is constant after setting, regardless of any small variations in the nut or the material
- Infinitely variable adjustment of the set stroke
- Stroke setting is preferred above all by experienced users and for large series production

## ADJUSTING THE SET STROKE ON FIREFOX® TOOLS

When using stroke setting, the setting force must first be set to maximum.

### Setting is done in four steps

1. The rivet set screw with colour scale (9) must be screwed in up to the stop with the enclosed hexagon screwdriver SW 3.
2. Then press in the green release button (6) fully.
3. Adjust the set stroke according to the scale (5) by turning the stroke adjuster (4). One line on the scale equals 1 mm of set stroke.
4. Release the green release button. If the release button does (6) not latch automatically, turn the stroke adjuster (4) carefully until it latches.

In contrast to the force adjustment method, blind rivet nuts of different lengths or changing material thicknesses require different set stroke settings.

## EXAMPLES

### BRN M6 9x15

Rivetable material thickness 0.25 - 3.5 mm  
for material thickness 1 mm, the set stroke is approx. 3.0 mm  
for material thickness 1.5 mm, the set stroke is approx. 2.5 mm

### BRN PolyGrip® M6 9x18

Rivetable material thickness 0.25–6.0 mm  
for material thickness 1 mm, the set stroke is approx. 6.0 mm

The values given are only guide values. because different settings may be required depending on the type of blind rivet nut.

## WHEN IS STROKE SETTING USED?

A constant set stroke should be used when a blind rivet nut size of the same length is set in **unchanging material** thicknesses. The set stroke corresponds to the distance the threaded mandrel is drawn into the nosepiece during the setting process and thus how far the blind rivet nut is compressed. With stroke setting, this distance can be adjusted mechanically on the riveting tool.

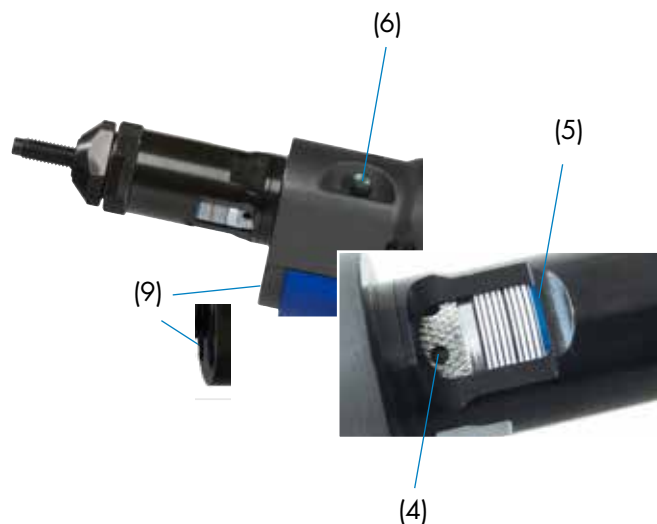
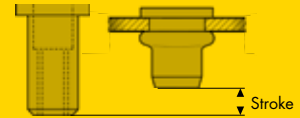

# THE BIRD PRO SERIES

Battery-powered blind rivet nut setting tools

The alliance of the best –  
The manufacturer-independent  
battery system sequence



## GESIPA® RELIES ON CAS

### Riveting with the CAS system

The first setting tools which can rivet with the CAS battery technology will be available in spring 2021. The complete Bird Pro series will be converted step by step, up to summer 2021. The new blind rivet nut setting tools **FireBird® Pro**, **FireBird® Pro Gold Edition** and the **FireBird® Pro S Gold Edition** are then also equipped with the new CAS batteries.

## BLDC TECHNOLOGY

A BLDC motor is a brushless DC motor that, instead of brushes that are susceptible to wear, uses electrical sensors to detect the rotor's position and commutate the stator coil via circuit breakers. A special software in the electronics controls the motor.

The advantages of a BLDC motor include high efficiency, long service life, particularly smooth running with a precision ball bearing and a reduction in electrical noise radiation.



**FireBird® Pro**

**FireBird® Pro  
Gold Edition**

**FireBird® Pro S  
Gold Edition**

## Advantages at a glance – Battery-powered blind rivet nut setting tools with BLDC

### Threaded mandrel

- Mandrel quick-change system
- Nosepiece and mandrel module taken from FireFox®

### LED input field

- Split LED input field
- Switches to energy-saving mode after 15 seconds
- Plastic cover to avoid damage and inadvertently changing the setting
- Presetting in steps of 10 and fine adjustment with 99 individual settings
- 10 freely selectable program memories

### Trigger

- Automatic screw-on after pressing the switch

### Li-Ion battery 18V

- Ultra M technology: Intelligent battery management for long-lasting battery packs
- Patented "AIR COOLED" charging technology
- Permanent Electronic Single Cell Protection (ESCP) when charging, for particularly long life.
- Processor-controlled charge and discharge management
- Capacity display with almost no self-discharge
- Capacity display with almost no self-discharge
- One battery pack for everything. 100% compatibility with all 18 V machines and chargers of the CAS partners

### Lighting

The light-emitting diodes precisely aligned to the work piece are integrated into the adjusting ring. There are three possible switch positions:

**Process-controlled:** The diodes remain illuminated after the setting process, which allows a continuous workflow even in bad lighting conditions. **Torch function:** Steady glow of diode (max. 10 minutes). **Lighting off:** saves electricity.

### Threaded mandrel magazine

- Storage of mandrels in the practical, screw-on mandrel magazine
- Three mandrels and matching nosepieces included in scope of delivery

### Autoreverse function

Immediately after mandrel break-off, this optional operating mode stops the pulling process and moves the jaw assembly back into the initial position. This saves time and energy while making sure the tool is immediately ready for use.

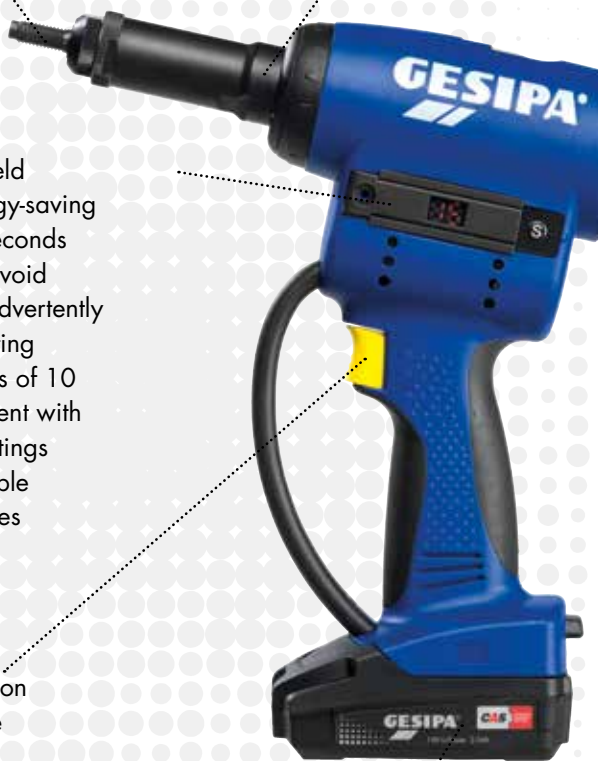

# FIREBIRD® PRO

**FireBird® Pro – The new battery powered blind rivet nut setting tool – for blind rivet nuts up to M8 steel!**



No. 167 9668



No. 167 9669



No. 167 9670



No. 167 9671



## ADVANTAGES OF SETTING FORCE ADJUSTMENT

- Controlling the tool through setting force adjustment protects material and thread and anchors blind rivet nuts securely in the material
- Quick and easy setting force adjustment via the display
- Does not need to be adjusted in case of changing material thicknesses or different lengths of blind rivet nuts

## TECHNICAL DATA

Weight: 2.4 kg with battery (2.0 Ah)  
 Traction power: 15,000 N  
 Drive: brushless motor  
 Stroke: 10.0 mm

## WORKING RANGE

Blind rivet nuts up to M10 Aluminium, M8 steel and M6 stainless steel

## SCOPE OF DELIVERY

Threaded mandrel and nosepiece M6 (in working position),  
 Threaded mandrel and nosepiece M4 and M5 (in magazine)  
 1x Hexagonal wrench  
 1x Double open ended wrench SW 24/27  
 Card Quick adjustment  
 Card Setting force pre-adjustment  
 Operating manual



## Child's play!

- 1 Read off number
  - 2 Enter number
  - 3 Set blind rivet nut
- ➔ Done!

## ADVANTAGES

- Foolproof operation
- Virtually no wear by brushless motor
- Modern Li-Ion battery technology
- Controlled solely by the setting force adjustment
- Intelligent error message
- Almost double the pulling displacement from 5.5 to 10 mm
- Fully automatic screw-off procedure

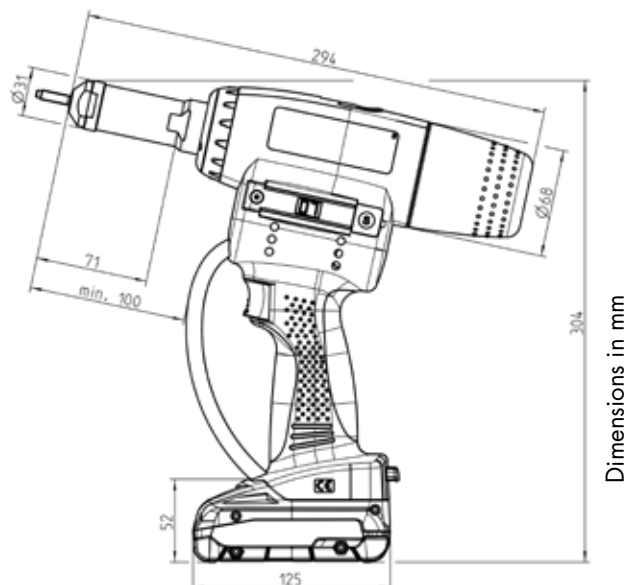

Dimensions in mm



# FIREBIRD® PRO GOLD EDITION

**FireBird® Pro Gold Edition –  
The new battery powered  
blind rivet nut setting tool –  
for blind rivet nuts up to  
M12 steel!**



**No. 167 9672**



**No. 167 9673**



**No. 167 9674**



**No. 167 9676**

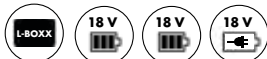

Setting force guide – Example: Steel M5

The values given are only guide values. The values should always be set slightly lower when setting for the first time!

## TECHNICAL DATA

Weight: 2.4 kg with battery (2.0 Ah)  
Traction power: 20,000 N  
Drive: brushless motor  
Stroke: 10.0 mm



**219**

Power per battery charge, threaded mandrels and nosepieces **page 219.**

## WORKING RANGE

Blind rivet nuts up to M12 alu and steel and M10 stainless steel.

## SCOPE OF DELIVERY

Threaded mandrel and nosepiece M6 (in working position),  
Threaded mandrel and nosepiece M8 and M10 (in magazine)  
1x Hexagonal wrench  
1x Double open ended wrench SW 24/27  
Card Quick adjustment  
Card Setting force pre-adjustment  
Operating manual



**222**

Spare parts, special accessories for FireBird® Pro/FireBird® Pro Gold Edition **page 222.**

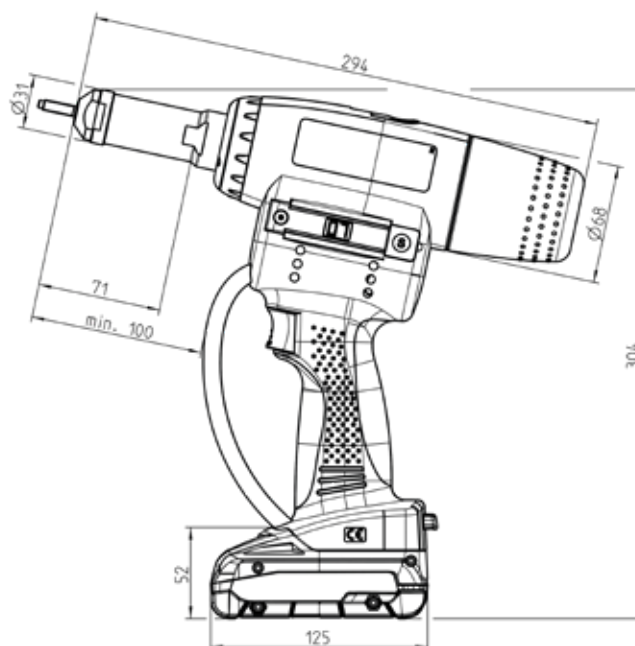

Dimensions in mm



# FIREBIRD® PRO S GOLD EDITION

Der FireBird® Pro with  
mechanical stroke setting

NEW



No. 167 9677



No. 167 9678



with mechanical  
stroke setting

## WHEN IS STROKE SETTING USED?

A constant set stroke should be used when a blind rivet nut size of the same length is set in unchanging material thicknesses. The set stroke corresponds to the distance the threaded mandrel is drawn into the nosepiece during the setting process and thus how far the blind rivet nut is compressed. With stroke setting, this distance can be adjusted mechanically on the riveting tool.

## ADVANTAGES OF STROKE SETTING

- Controlling the tool through stroke setting guarantees the height of the blind rivet nuts is constant after setting, regardless of any small variations in the nut or the material
- Infinitely variable adjustment of the set stroke
- Stroke setting is preferred above all by experienced users and for large series production

## SCOPE OF DELIVERY

Threaded mandrel and nosepiece M6  
(in working position),  
Threaded mandrel and nosepiece M8  
and M10 (in magazine)  
1x Hexagonal wrench  
1x Double open ended wrench SW 24/27  
1x Double open ended wrench SW 27/30  
Card Quick adjustment  
Card Setting force pre-adjustment  
Operating manual

Technical data, working range and  
advantages analog to FireBird® Pro  
Gold Edition

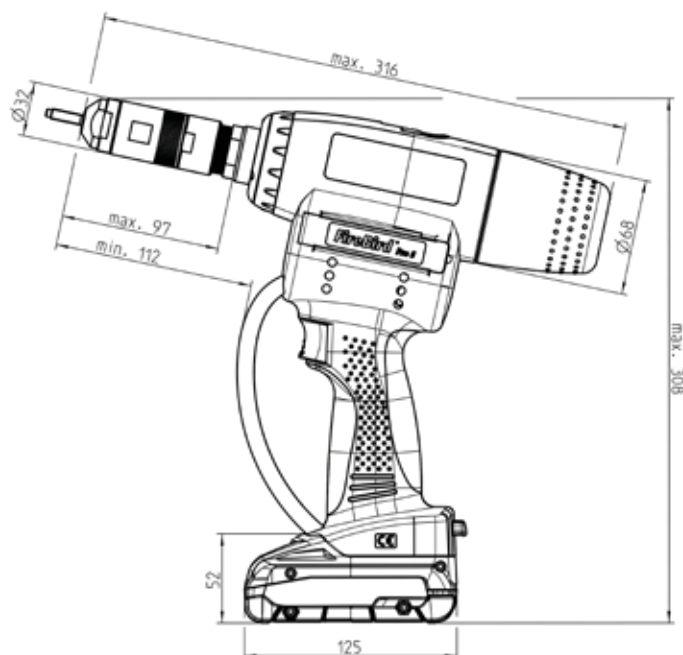

Dimensions in mm

## WORKING RANGE FIREBIRD® PRO GE AND FIREBIRD® PRO S GE:

Sets blind rivet nuts up to M12 alu and steel and M10 stainless steel.

## POWER PER BATTERY CHARGE/THREADED MANDRELS AND NOSEPIECES FOR FIREBIRD® PRO TOOLS

Inner thread	Material	approx. pc per charging process FireBird® Pro	Threaded mandrel	Nosepiece	approx. pc per charging process FireBird® Pro GE / FireBird® Pro S GE	Threaded mandrel	Nosepiece
			No.	No.		No.	No.
M3	Alu	1,200	143 6211*	143 6218*	1,200	143 6211*	143 6218*
M3	Steel/Stainless steel	1,100			1,100		
M4	Alu	1,100	143 6212	143 6219	1,100	143 6212	143 6219
M4	Steel/Stainless steel	1,000			1,000		
M5	Alu	950	143 6213	143 6220	950	143 6213	143 6220
M5	Steel/Stainless steel	900			900		
M6	Alu	900	143 6214	143 6221	900	143 6214	143 6221
M6	Steel/Stainless steel	800			800		
M8	Alu	850	143 6215*	143 6222*	850	143 6215	143 6222
M8	Steel/Stainless steel	550			550		
M10	Alu	750	143 6216*	143 6223*	750	143 6216	143 6223
M 10	Steel/Stainless steel	500			500		
M12	Alu	-	-	-	500	143 6217*	143 6224*
M12	Steel	-			300		

\*Available as special accessory



222

Spare parts, special accessories for FireBird® Pro S Gold Edition **page 222.**



242

All threaded mandrels and nose-piece **page 242.**

### Example and application:

Extended nosepiece and threaded mandrel for difficult-to-access and/or deep-seated applications



# FIREBIRD®

The reliable blind rivet nut setting tool with mechanical stroke setting for blind rivet nuts up to M10 Alu.

No. 145 7414

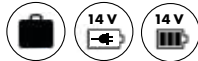

No. 145 7413

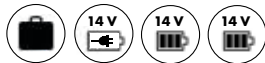

## TECHNICAL DATA

Weight: 2.1 kg with battery  
 Setting force: 13,000 N  
 Drive: DC motor  
 Stroke: 5.5 mm

## WORKING RANGE

Blind rivet nuts up to M10 aluminium, up to M8 steel and up to M6 stainless steel

## SCOPE OF DELIVERY

Threaded mandrel and nose piece M6 (in working position)  
 Threaded mandrel and nose piece M4 und M5 (in magazine)  
 1x hexagonal wrench  
 2x double open ended wrench SW 24/27  
 Operating manual

## ADVANTAGES

- Reduced torque
- Automatic switch-off
- Automatic drill-out function
- High energy density
- Low weight
- Simple and safe drilling of

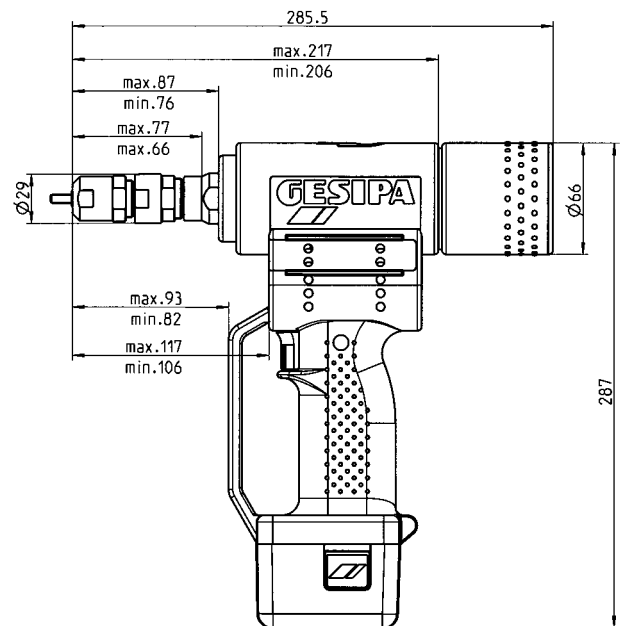

Dimensions in mm



**222**

Spare parts, special accessories for FireBird® page 222

## FireBird® – Blind rivet nut setting tool

### POWER PER BATTERY CHARGE/THREADED MANDRELS AND NOSEPIECES

Blind rivet nuts inner thread	Material	approx. pc per charging process 2,0 Ah Li-Ion battery	No.	
			Threaded mandrel	Nosepiece
M3	Alu	<b>1000</b>	<b>143 5052*</b>	<b>143 5065*</b>
M3	Steel/Stainless steel	<b>900</b>		
M4	Alu	<b>900</b>	<b>143 5055</b>	<b>143 5066</b>
M4	Steel/Stainless steel	<b>800</b>		
M5	Alu	<b>800</b>	<b>143 5056</b>	<b>143 5067</b>
M5	Steel/Stainless steel	<b>750</b>		
M6	Alu	<b>700</b>	<b>143 5059</b>	<b>143 5068</b>
M6	Steel/Stainless steel	<b>500</b>		
M8	Alu	<b>600</b>	<b>143 5063*</b>	<b>143 5069*</b>
M8	Steel	<b>300</b>		
M10	Alu	<b>500</b>	<b>143 5064*</b>	<b>143 5070*</b>

\* Available as special accessory

 **242** All threaded mandrels and nosepieces **page 242.**

## **FIREBIRD®** Basic tool for blind rivet nut studs conversion kit

The blind rivet nut studs conversion kits enable the FireBird® to be used to set M4 and M8 blind rivet nut studs.

### FireBird® Basic tool\*

**No. 146 4336**

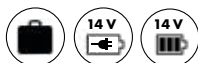

\* The tool is delivered without threaded mandrels and nosepieces. Please order the corresponding conversion kit.

**page 223**



# SPARE PARTS / SPECIAL ACCESSORIES Battery powered blind rivet nut setting tools

## 14,4 V/2,0 Ah LI-ION BATTERY

Weight: 0.36 kg



NEW

**No. 166 6440**

## 14,4 V/4,0 Ah LI-ION BATTERY

Weight: 0.58 kg

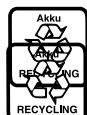

NEW

**No. 166 6441**

## CHARGER 14.4 V LI-ION

### Technical data

Input voltage: 230 V / 50 Hz  
 Output voltage: 14.4 V DC  
 Recharging time: 50 to 100 minutes (battery depending)  
 Weight: 0.6 kg



**No. 145 7282**

## 18V LI-POWER 2,0 AH BATTERY

Weight: 0,4 kg / available as special accessory



**No. 167 9689**

## 18V LiHD 4,0 AH BATTERY

Weight: 0,6 kg / available as special accessory



**No. 167 9690**

## CHARGER FOR 18,0 V LI-ION BATTERY

### Technical data

Input voltage: 100 - 240 V / 50 - 60 Hz  
 Output voltage: 21 V DC  
 Charging time: 2.0 Ah = approx. 40 minutes  
                   4.0 Ah = approx. 80 minute  
 Weight: 0.6 kg



Note: Equipped with Euro plug as standard (other versions on request)

EU packed  
**No. 167 9694**

UK packed  
**No. 167 9695**

US packed  
**No. 167 9696**

## THREADED MANDREL AND NOSEPIECE SET FOR BLIND RIVET NUT SETTING TOOLS

Equipped with a complete set of nosepieces and threaded mandrels (M3 to M12) in a plastic carrying case. Suitable for:

- FireBird® Pro
- FireBird® Pro Gold Edition / FireBird® Pro S Gold Edition
- FireFox® 2 (all versions except FireFox® 2 C)



Metric dimensions  
**No. 145 8111**

UNC/UNF dimensions  
**No. 145 8112**

## CONVERSION KIT FOR BLIND RIVET NUT STUDS

	No. FireBird® Pro tools	No. FireBird® tools	BRN thread protrusion	
			min.	max.*
M4	<b>143 6285</b>	<b>143 5117</b>	8	22
M5	<b>143 6286</b>	<b>143 5118</b>	9	22
M6	<b>143 6287</b>	<b>143 5119</b>	10	22
M8	<b>143 6288</b>	<b>143 5121</b>	12	22



\* A corresponding extended no-sepiece must be used for thread protrusions > 22 mm.

## CONVERSION KIT FOR COARSE THREAD

	No. FireBird® Pro tools	No. FireBird® tools	BRN thread protrusion	
			min.	max.*
M5	<b>145 8170</b>	<b>145 7434</b>	9	22
M6	<b>145 8171</b>	<b>145 7476</b>	10	22

## CONVERSION KIT FOR HEXAGON SOCKET SCREWS

For the FireBird® Pro series

### Can be operated with DIN EN ISO 4762 allen screws instead of threaded mandrels

Special adapters available as accessory for M4 to M8 threads allows the original threaded mandrels to be replaced by allen screws: A substantial cost saving without any quality or performance loss and higher endurance when far away from the spare parts source. Best results are obtained with 12.9 grade screws.



Example:  
Conversion kit SL30

Conversion kit for blind rivet nuts	No.	Conversion kit for extended DIN screws SL30 No.	Conversion kit for extended DIN screws SL50 No.
M4 x min. 20	<b>143 6264</b>	M4 x min. 50	<b>145 8182</b>
M5 x min. 25	<b>143 6279</b>	M5 x min. 55	<b>145 8183</b>
M6 x min. 30	<b>143 6283</b>	M6 x min. 60	<b>145 8184</b>
M8 x min. 30	<b>143 6284</b>	M8 x min. 60	<b>145 8178</b>
		M4 x min. 70	<b>152 9115</b>
		M5 x min. 75	<b>156 7148</b>
		M6 x min. 80	<b>156 7147</b>
		M7 x min. 80	<b>1567146</b>

# HYDRO-PNEUMATIC BLIND RIVET NUT SETTING TOOLS

Technological leadership, experience and in-house production – The hydro-pneumatic blind rivet nut setting tool from GESIPA®



## WHAT RIVETS WHAT?

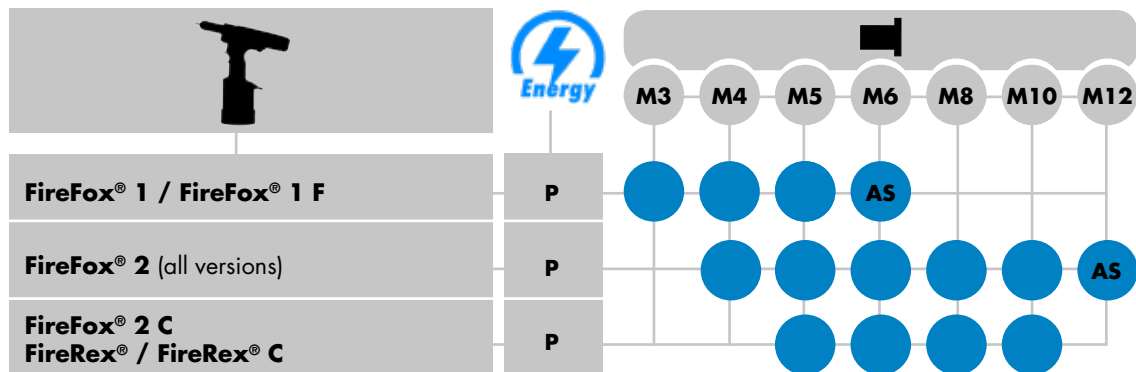

- P:** Hydro-pneumatic tool
- A:** Alu/Copper
- S:** Steel
- E:** Stainless Steel

**Blue box:** All materials (ASE) can be riveted. Where there are exceptions, the letters of the rivetable materials are provided directly in the box.



## Hydro-pneumatic blind rivet nut setting tools

226



FireFox® 1



FireFox® 1 F



FireFox® 2



FireFox® 2 F



FireFox® 2 F L



FireFox® 1 F / FireFox® 2  
with conversion kit for  
blind rivet nut studs



FireFox® 1 F Axial eco



FireFox® 2 F Axial eco



FireFox® 2 F Axial eco  
with contact pressure monitoring  
and counting sensor



FireFox® 2 C WinTech



FireRex®



FireRex® 2 C WinTech

# FIREFOX® 1

The hydropneumatic blind rivet nut setting tool for M3-M6 – stroke or setting force controlled

No. 160 5610

## TECHNICAL DATA

Weight:	2.2 kg
Maximum stroke:	approx. 7.5 mm
Adjustable traction force:	up to approx. 12 kN at 6 bar
Operating air pressure:	5-7 bar
Air hose connection:	6 mm Ø (1/4")
Air consumption: approx.	1-2 ltr.per setting process (depending on nuts size)

## WORKING RANGE

Blind rivet nuts from M3 up to M6 of all materials, except M6 stainless steel.

## SCOPE OF DELIVERY

Threaded mandrel and nosepiece M6  
(in working position)  
Threaded mandrel and nosepiece M3, M4 and M5  
(in magazine)  
2x double open ended wrenches SW 24/27  
1x hexagon screw driver SW 3  
1x oil refill bottle with hydraulic oil 100 ml  
1x oil refill can  
Rubber foot  
Quick setting guide  
Colour code card  
Operating instructions with spare parts list

## ADVANTAGES

- Stroke- or setting-force adjustment possible
- Maximum stroke clearly identified by blue ring on stroke scale (1)
- Fast and precise setting force adjustment with colour-coded setting ring (2)
- New stroke scale quick and easy to set even under poor light conditions



 **236** Spare parts, special accessories **page 236**

 **242** Threaded mandrels and nosepieces **page 242**

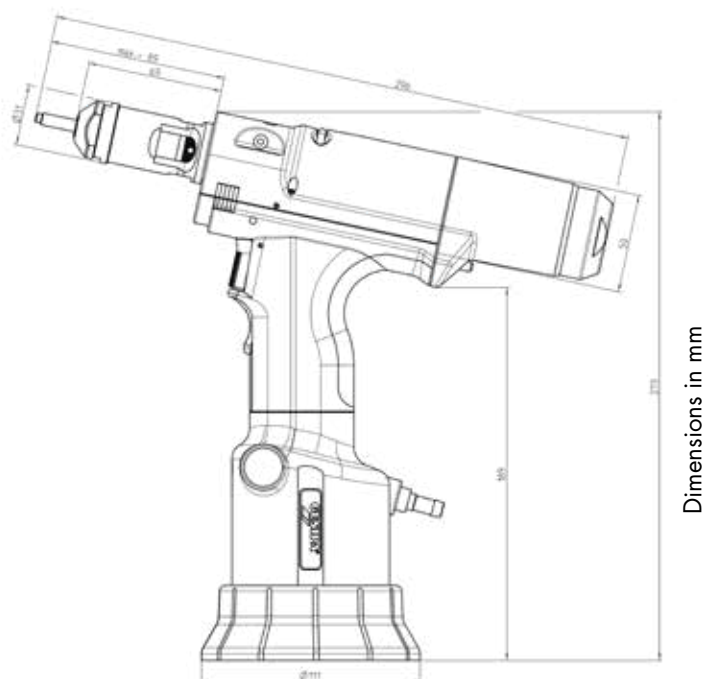

# FIREFOX® 1 F

The hydropneumatic blind rivet nut setting tool with setting force adjustment for M3-M6

No. 145 8198

## TECHNICAL DATA

Weight:	2 kg
Maximum stroke:	approx. 7.5 mm
Adjustable traction force:	up to approx. 12 kN at 6 bar
Operating air pressure:	5-7 bar
Air hose connection:	6 mm Ø (1/4")
Air consumption: approx.	1-2 ltr. per setting process (depending on nutsize)

## WORKING RANGE

Blind rivet nuts from M3 up to M6 of all materials, except M6 stainless steel.

## SCOPE OF DELIVERY

Threaded mandrel and nosepiece M6  
(in working position)  
Threaded mandrel and nosepiece M3, M4 and M5  
(in magazine)  
2x double open ended wrenches SW 24/27  
1x hexagon screw driver SW 3  
1x oil refill bottle with hydraulic oil 100 ml  
1x oil refill can  
Rubber foot  
Quick setting guide  
Colour code card  
Operating instructions with spare parts list

## ADVANTAGES

- Easy to use, reliable and safe
- Sets small blind rivet nuts optimally and safely without damaging the material to be joined
- Setting takes place exclusively using setting force adjustment
- Optimum protection of the blind rivet nut thread
- Ergonomic design reduces fatigue when working



With silencer and improved setting technology

 **236** Spare parts, special accessories **page 236**

 **242** Threaded mandrels and nosepieces **page 242**

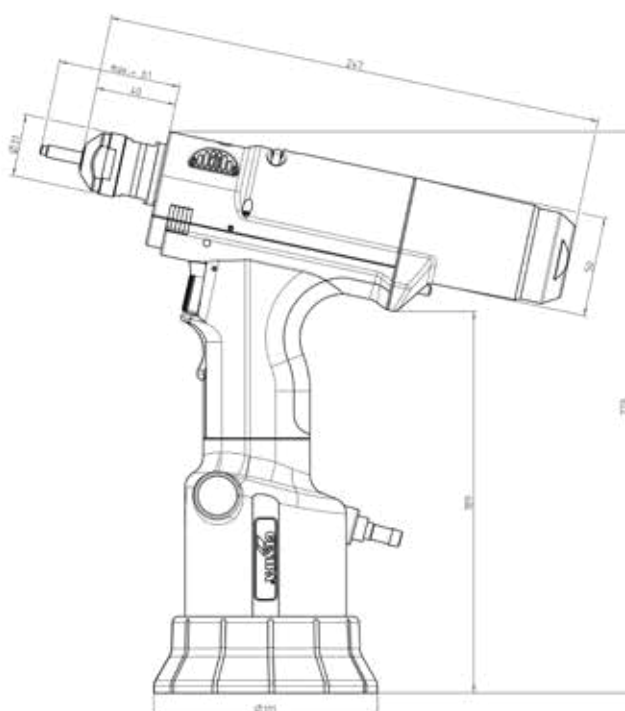

Dimensions in mm

# FIREFOX® 2

The hydro-pneumatique blind rivet nut setting tool – stroke or setting force controlled

No. 145 8086

## TECHNICAL DATA

Weight:	2.4 kg
Adjustable stroke,max:	10mm
Adjustable traction force, max:	22 kN at 6 bar
Operating air pressure:	5-7 bar
Air hose connection:	6 mm Ø (1/4")
Air consumption:	approx. 2 to 4 ltr. per rivet nut (depending on nut size)

## WORKING RANGE

Sets blind rivet nuts from M4 to M10 in all materials as well as M12 in aluminium and steel.

## SCOPE OF DELIVERY

Threaded mandrel and nosepiece M6 (in working position)  
Threaded mandrel and nosepiece M4, M5 and M8 (in magazine)  
2x double open ended wrenches SW 24/27  
1x hexagon screw driver SW 3  
1x oil refill bottle with hydraulic oil 100 ml  
1x oil refill can  
Quick setting guide  
Colour code card  
Operating instructions with spare parts list

## ADVANTAGES

- Stroke- or setting-force adjustment possible
- Maximum stroke clearly identified by blue ring on stroke scale (1)
- Fast and precise setting force adjustment with colour-coded setting ring (2)
- New stroke scale quick and easy to set even under poor light conditions



	<b>236</b> Spare parts, special accessories <b>page 236</b>
	<b>242</b> Threaded mandrels and nosepieces <b>page 242</b>

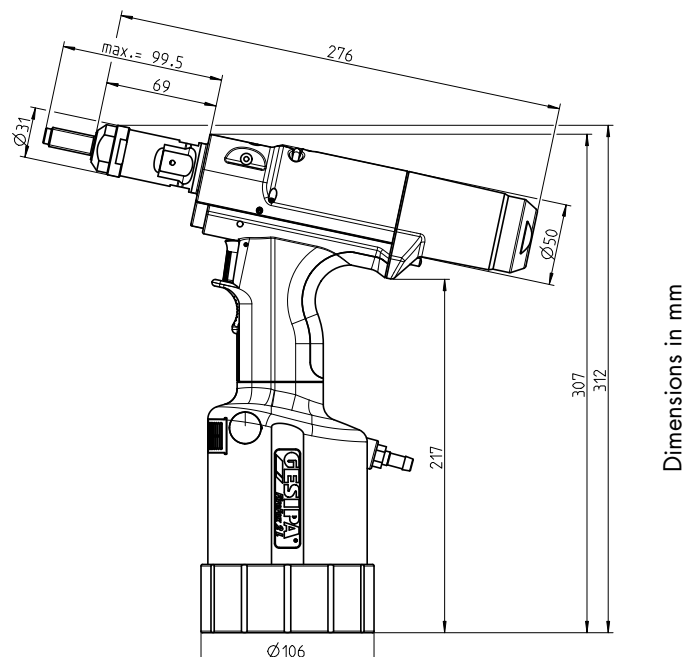

# FIREFOX® 2 F

The hydro-pneumatic blind rivet nut setting tool with pure setting force adjustment

No. 145 1045

## TECHNICAL DATA

Weight:	2.4 kg
Adjustable stroke, max:	10mm
Adjustable traction force, max:	22 kN at 6 bar
Operating air pressure:	5-7 bar
Air hose connection:	6 mm Ø (1/4")
Air consumption:	approx. 2 to 4 ltr. per rivet nut (depending on nut size)

## WORKING RANGE

Sets blind rivet nuts from M4 to M10 in all materials as well as M12 in aluminium and steel.

## SCOPE OF DELIVERY

Threaded mandrel and nose piece M6 (in working position)  
Threaded mandrel and nose piece M4, M5 and M8 (in magazine)  
2x double open ended wrenches SW 24/27  
1x hexagon screw driver SW 3  
1x oil refill bottle with hydraulic oil 100 ml  
1x oil refill can  
Quick setting guide  
Colour code card  
Operating instructions with spare parts list

## ADVANTAGES

- With pure setting force adjustment
- Fast and precise setting force adjustment with colour-coded setting ring
- Optimum protection of material to be joined and blind rivet nut thread
- Secure anchoring of the blind rivet nut
- High process reliability



For special applications also with left-hand thread available! **page 230**

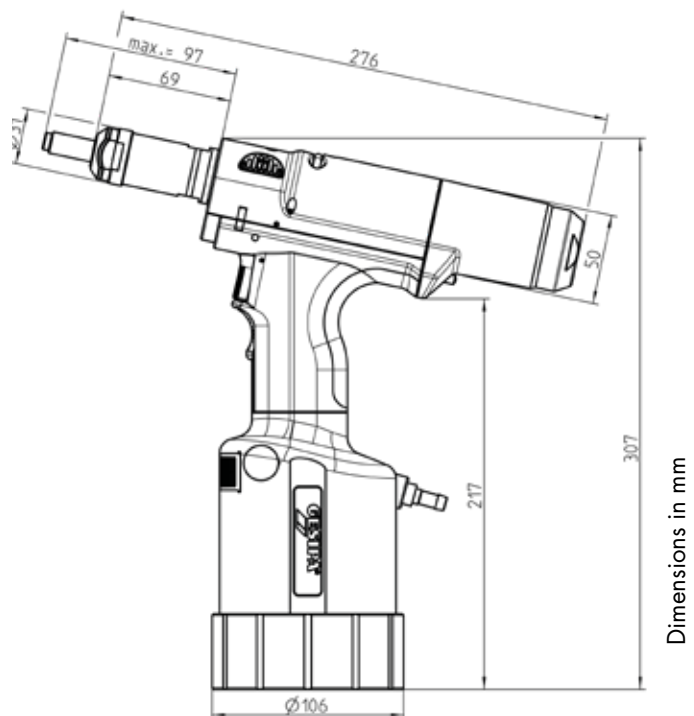

**236** Spare parts, special accessories **page 236**

**242** Threaded mandrels and nose pieces **page 242**

# FIREFOX® 2 FL

The hydropneumatic blind rivet setting tool for setting blind rivet nuts with left-hand thread.



<b>FireFox® 2 F L – M6</b>	<b>No. 145 1037</b>
<b>FireFox® 2 F L – M4</b>	<b>No. 145 1035</b>
<b>FireFox® 2 F L – M5</b>	<b>No. 145 1036</b>
<b>FireFox® 2 F L – M8</b>	<b>No. 145 8098</b>
<b>FireFox® 2 F L – M10</b>	<b>No. 145 8099</b>
<b>FireFox® 2 F L – M12</b>	<b>No. 145 8100</b>



## TECHNICAL DATA

Weight:	2.4 kg
Adjustable stroke, max:	10 mm
Adjustable traction force, max:	22 kN at 6 bar
Operating air pressure:	5-7 bar
Air hose connection:	6 mm Ø (1/4")
Air consumption:	approx. 2 to 4 ltr. per rivet nut (depending on nut size)

## WORKING RANGE

Sets blind rivet nuts from M4 to M10 in all materials as well as M12 in aluminium and steel.

## SCOPE OF DELIVERY

Threaded mandrel and nosedpiece M6 (in working position)  
Threaded mandrel and nosedpiece M4, M5 and M8 (in magazine)  
2x double open ended wrenches SW 24/27  
1x hexagon screw driver SW 3  
1x oil refill bottle with hydraulic oil 100 ml  
1x oil refill can  
Quick setting guide  
Colour code card  
Operating instructions with spare parts list

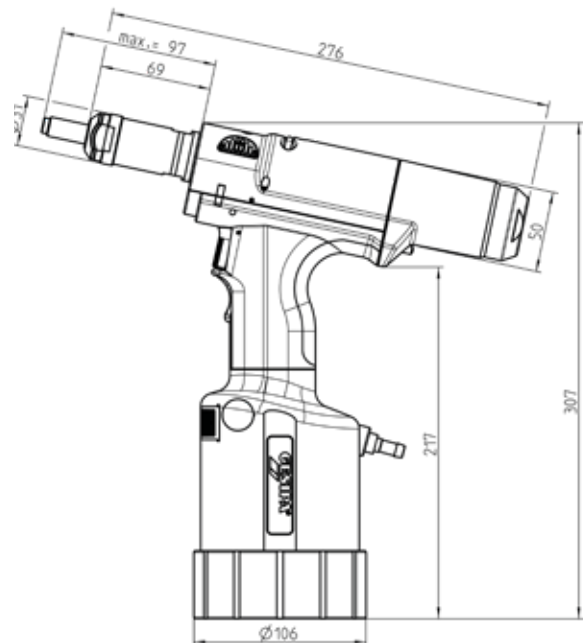

**236**

Spare parts, special accessories **page 236**



**242**

Threaded mandrels and nosedpieces **page 242**

# **FIREFOX® 1 F / FIREFOX® 2** with conversion kit for blind rivet nut studs

The blind rivet stud conversion kits enable the FireFox® tools to be used to set blind rivet studs.



## **FireFox® 1 F Basic tool** **No. 145 1106**

### **TECHNICAL DATA**

Analog to FireFox® 1F

### **WORKING RANGE**

Sets blind rivet studs from M4 to M6

### **SCOPE OF DELIVERY**

2x double open ended wrenches SW 24/27  
1x hexagon screw driver SW 3  
1x oil refill bottle with hydraulic oil 100 ml  
1x oil refill can  
Rubber foot  
Quick setting guide  
Colour code card  
Operating instructions with spare parts list

## **FireFox® 2 Basic tool** **No. 145 8096**

### **TECHNICAL DATA**

Analog to FireFox® 2

### **WORKING RANGE**

Sets blind rivet studs from M4 to M8

### **SCOPE OF DELIVERY**

2x double open ended wrenches SW 24/27  
1x hexagon screw driver SW 3  
1x oil refill bottle with hydraulic oil 100 ml  
1x oil refill can  
Quick setting guide  
Colour code card  
Operating instructions with spare parts list



The tool is delivered without threaded mandrels and nosepieces. Please order the corresponding conversion kit. **page 237**

# FIREFOX® 1 F AXIAL ECO

The hydropneumatic blind rivet nut setting tools for working vertically



FireFox® 1 F Axial eco – M3	<b>No. 145 1103</b>
FireFox® 1 F Axial eco – M4	<b>No. 145 1104</b>
FireFox® 1 F Axial eco – M5	<b>No. 145 8199</b>
FireFox® 1 F Axial eco – M6	<b>No. 145 1105</b>



## TECHNICAL DATA

Weight:	2.8 kg
Max. setting stroke:	approx. 7.5 mm
Max. setting force, adjustable:	approx. 12 kN at 6 bar
Operating pressure:	5-7 bar
Hose connection:	6 mm Ø (1/4")
Compressed air consumption:	max. 2 l per setting (depending on nut size)

Working range and scope of delivery analog to FireFox® 1F

## ADVANTAGES

- Costs-effective entry model
- Ideally suited for installation in assembly cells, fixtures or semi-automatic workstations
- Handy for processing blind rivet nuts in places that require vertical riveting action
- Can be attached to a balancer

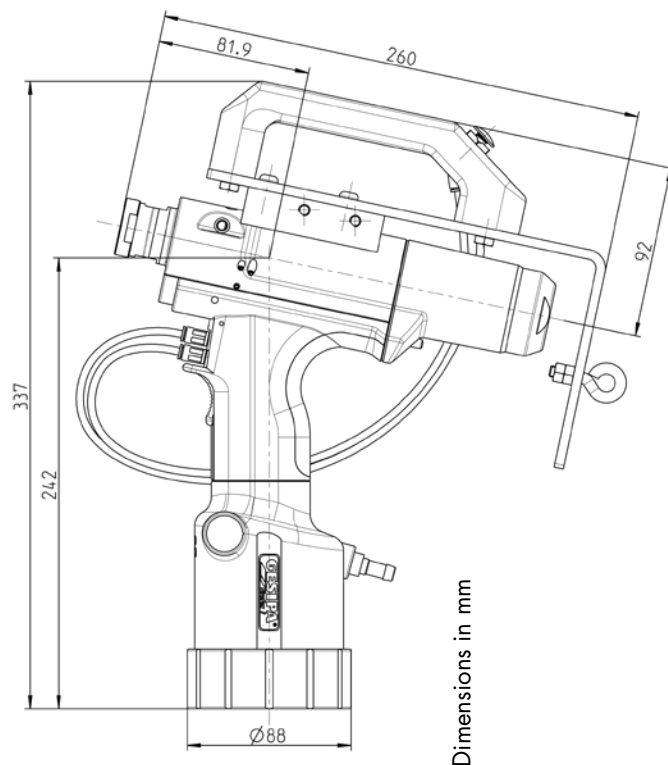



# FIREFOX® 2 F AXIAL ECO



- FireFox® 2 F Axial eco – M4**    **No. 145 1040**
- FireFox® 2 F Axial eco – M5**    **No. 145 1041**
- FireFox® 2 F Axial eco – M6**    **No. 145 8103**
- FireFox® 2 F Axial eco – M8**    **No. 145 1042**
- FireFox® 2 F Axial eco – M10** **No. 145 1043**
- FireFox® 2 F Axial eco – M12** **No. 145 1044**

## TECHNICAL DATA

Weight:	3.3 kg
Max. setting stroke:	10 mm
Drive:	Pneumatic motor
Setting force:	22 kN at 6 bar
Operating pressure:	5-7 bar
Hose connection:	6 mm Ø (1/4")
Compressed air consumption:	max. 2 l up to 4 l per setting (depending on nut size))

Working range and scope of delivery analog to FireFox® 2F  
 Advantages analog to FireFox® 1F Axial eco

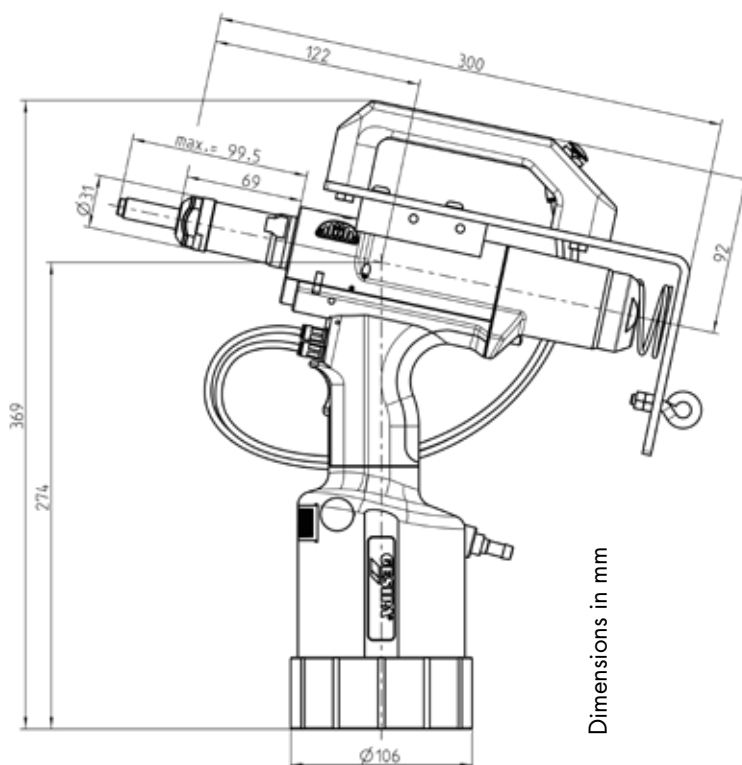

Dimensions in mm

**236** Spare parts, special accessories **page 236**

**242** Threaded mandrels and nosepieces **page 242**

# **FIREFOX® 2 F AXIAL ECO** with contact pressure monitoring and counting sensor

**With contact pressure monitoring and counting sensor – in three versions**

Consultation, price and delivery time on request

## **TECHNICAL DATA**

Weight:	3.3 kg
Max. setting stroke:	10 mm
Drive:	Pneumatic motor
Setting force:	22 kN at 6 bar
Operating pressure:	5-7 bar
Hose connection:	6 mm Ø (1/4")
Compressed air consumption:	max. 2 l up to 4 l per setting (depending on nut size)

## **WORKING RANGE**

Sets blind rivet nuts from M4 to M12 in all materials except M12 stainless steel.

## **SCOPE OF DELIVERY**

2x double open ended wrenches SW 24/27  
1x hexagon screw driver SW 3  
1x oil refill bottle with hydraulic oil 100 ml  
1x oil refill can  
Quick setting guide  
Colour code card  
Operating instructions with spare parts list

## **ADVANTAGES**

- Low-price entry-level model for process monitoring
- Ideally suited for instillation in assembly cells, fixtures or semi-automatic workstations
- Handy for processing blind rivet nuts in places that require vertical riveting action
- Can be attached to a balancer

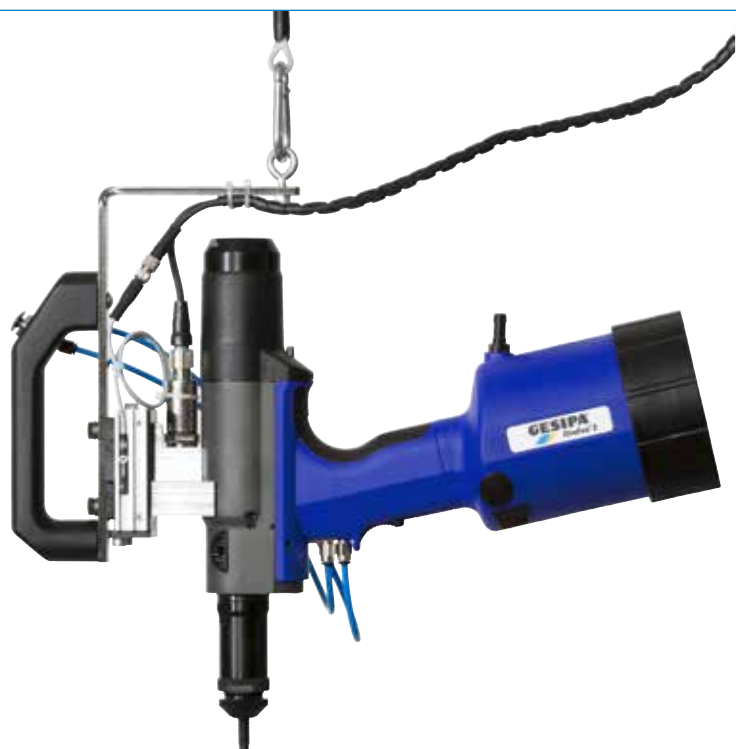

Version with contact pressure monitoring and counting sensor

This tool is based on the tried-and-tested FireFox® 2 F Axial eco.

Three versions are available: with contact pressure monitoring, with counting function, or with contact pressure monitoring and counting function.

The counting function is realised by an analogue oil pressure sensor and the contact pressure monitoring via an adjustable spring mechanism.

Using an analogue oil pressure sensor allows the threshold value of the oil pressure, above which the setting process is recognized as valid, to be set on a programmable logic controller (PLC) that is not part of the standard scope of delivery.

# FIREFOX® 2 C WINTECH

## FireFox® 2 C – With setting process monitoring

The FireFox® 2 C WinTech is based on the proven TAURUS® C model. Here the setting process is analysed via integrated electronics using stroke and force sensors. The user can define an OK window by means of a special software. A coloured LED on the tool shows the results of the setting process monitoring which can also be recorded and processed via data line.



Advice and delivery time on request

### TECHNICAL DATA

Weight:	3.1 kg
Max. setting stroke:	10 mm
Setting force:	22 kN at 6 bar
Operating pressure:	5-7 bar
Hose connection:	6 mm Ø (1/4")
Compressed air consumption:	max. 2 l up to 4 l per setting (depending on nut size)

### WORKING RANGE

Sets blind rivet nuts from M5 to M10 in all materials

### APPLICATIONS

In the serial production of safety component parts as well as in automated setting processes the FireFox® C allows checking and documentation of the setting process.

### ADVANTAGES

- High process safety
- Documentation of each individual setting process
- Less scrap since errors can be immediately identified
- Avoidance of additional costs/quality costs due to NOK parts

### NOK WINDOW

Even incompletely fitted blind rivet nuts are detected!

### EXAMPLE OF OK PROCESS

Window entry and exit at customer-defined positions

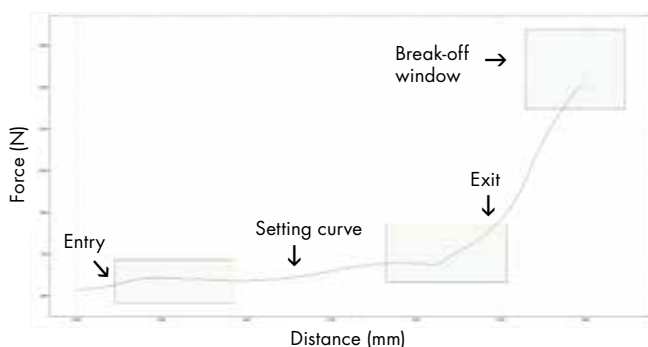

### EXAMPLE OF NOT OK PROCESS

Material to be joined too thin due to missing component

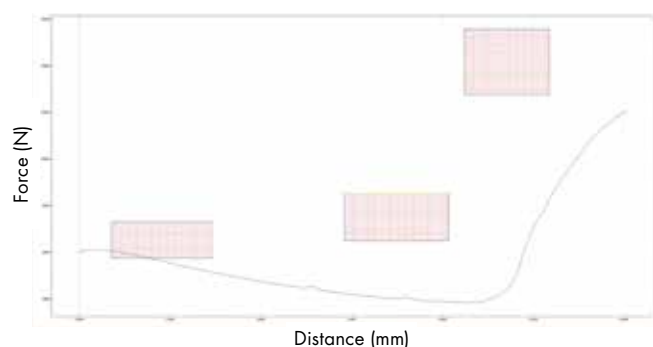

# SPARE PARTS / SPECIAL ACCESSORIES FireFox® series

## FLEXIBLE BASE – FIREFOX® 1 AND 2

With the new flexible base made from NBR and the larger surface area, the TAURUS® tools stand even more stably.



**Flexible base** for FireFox® 1  
(for all versions)

**No. 143 6394**

**Flexible base** for FireFox® 2  
(for all versions)

**No. 143 6371**

## PROTECTIVE COVER for FireFox® 2 with stroke setting.

An additional **protective cover** over the head ensures that the stroke length setting is not unintentionally changed.



**Protective cover**

**No. 143 6313**

## SWIVEL AIR CONNECTOR for FireFox® 1 F & 2 (all versions except FireFox® 2 C)



**No. 143 5479**

## THREADED MANDREL AND NOSEPIECE SET FOR BLIND RIVET NUT SETTING TOOLS

Equipped with a complete set of nosepieces and threaded mandrels (M3 to M12) in a plastic carrying case. Suitable for:

- FireFox® 2 (all versions except FireFox® 2 C)
- FireBird® Pro
- FireBird® Pro Gold Edition / FireBird® Pro S Gold Edition



Metric dimensions

**No. 145 8111**

UNC/UNF dimensions

**No. 145 8112**

## TOOL MOUNT\* for FireFox® 1 F & 2 (all versions except FireFox® 2 C)

For integration into automated systems or connection to handling modules

\*Tool mount is not available separately. It is supplied mounted on a new tool or can be retrofitted to an existing tool at the Walldorf plant or in a qualified GESIPA® workshop.



**No. 145 8175**



## CONVERSION KIT FOR BLIND RIVET NUT STUDS

Article	No.	BRN thread protrusion	
		min.	max.* <sup>1</sup>
M4	<b>143 6285</b>	8	22
M5	<b>143 6286</b>	9	22
M6	<b>143 6287</b>	10	22
M8* <sup>2</sup>	<b>143 6288</b>	12	22

\*<sup>1</sup> A correspondingly extended nosepiece must be used for thread protrusion > 22 mm.

\*<sup>2</sup> not FireFox® 1 F



### SCREW NOSEPIECE for conversion kit

Description	No.
Screw nosepiece M4	<b>143 5100</b>
Screw nosepiece M5	<b>143 5102</b>
Screw nosepiece M6	<b>143 5103</b>
Screw nosepiece M8* <sup>2</sup>	<b>143 5105</b>

## CONVERSION KIT FOR COARSE THREAD

	No. FireFox® tools	BRN thread protrusion	
		min.	max.* <sup>1</sup>
M5	<b>145 8170</b>	9	22
M6	<b>145 8171</b>	10	22

Further dimensions on request.

### SCREW INSERT for conversion kit

Description	No.
Screw insert M4	<b>143 6278</b>
Screw insert M5	<b>143 6280</b>
Screw insert M6	<b>143 6281</b>
Screw insert M8* <sup>2</sup>	<b>143 6282</b>

## CONVERSION KIT FOR HEXAGON SOCKET SCREWS

### Can be operated with DIN EN ISO 4762 allen screws instead of threaded mandrels.

Special adapters available as accessory for M4 to M8 threads allows the original threaded mandrels to be replaced by allen screws: A substantial cost saving without any quality or performance loss and higher endurance when far away from the spare parts source. Best results are obtained with 12.9 grade screws

Conversion kit for blind rivet nuts	No.
M4 x min. 20	<b>143 6264</b>
M5 x min. 25	<b>143 6279</b>
M6 x min. 30	<b>143 6283</b>
M8* <sup>2</sup> x min. 30	<b>143 6284</b>

\*<sup>2</sup> not FireFox® 1 F

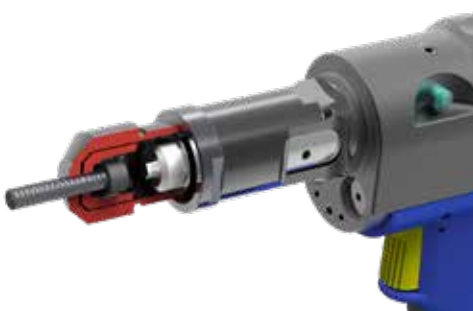

Conversion kit for extended DIN screws SL30 No.		Conversion kit for extended DIN screws SL50 No.	
M4 x min. 50	<b>145 8182</b>	M4 x min. 70	<b>152 9115</b>
M5 x min. 55	<b>145 8183</b>	M5 x min. 75	<b>156 7148</b>
M6 x min. 60	<b>145 8184</b>	M6 x min. 80	<b>156 7147</b>
M8 x min. 60	<b>145 8178</b>	M7 x min. 80	<b>1567146</b>

# SPARE PARTS / SPECIAL ACCESSORIES FireFox® series

## CONVERSION KIT FOR CRIMP NUTS

FireFox® 2 (all variants)

### Use

The conversion kits allow the use of the FireFox® 2 for inserting crimp nut sizes M6 to M12. This is done as fast as usual by drilling the nut on and off automatically and by fast insertion.

### Delivered version

The conversion kit is delivered as a pre-assembled accessory. For inserting crimp nuts into very thick steel plates special sizes of threaded mandrels have to be used.

### Installation

For installing the conversion kit special tools are not necessary. This can be done by using the wrench that comes with the FireFox® 2 standard version.

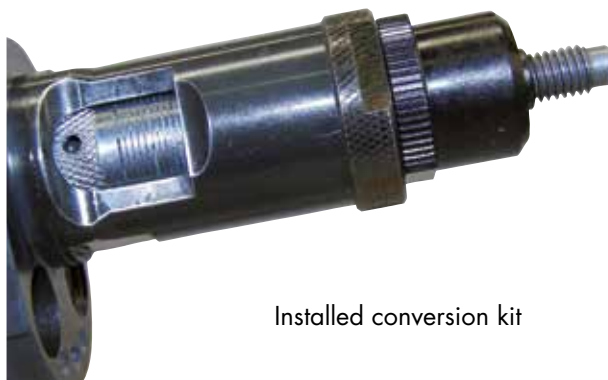

Installed conversion kit

Conversion kit for setting nut	No.
M6	<b>143 6354</b>
M8	<b>143 6355</b>
M10	<b>143 6356</b>
M12	<b>143 6357</b>



The conversion kit is delivered as a preassembled accessory.



The spring-loaded centering bush allows the setting nut to be inserted in an optimum way.

### Threaded mandrels for conversion kit

Description	No.
Threaded mandrel M6	<b>143 6214</b>
Threaded mandrel M8	<b>143 6215</b>
Threaded mandrel M10	<b>143 6216</b>
Threaded mandrel M12	<b>143 6217</b>



The nut automatically drills on after having been slightly pressed onto the threaded mandrel.



Inserted nut after process has been finished.

# FIREFOX®

The hydropneumatic blind rivet nut setting tool with external pressure booster for greater flexibility

## TECHNICAL DATA

Weight:	4.4 kg
Max. setting stroke, adjustable:	10 mm
Max. setting force, adjustable:	22 kN bei 6 bar
Operating pressure:	5-7 bar
Hose connection:	6 mm Ø (1/4")
Compressed air consumption:	approx. 2 to 4 l per setting (depending on nut size)



## WORKING RANGE

Sets blind rivet nuts from M5 to M12 in all materials

## SCOPE OF DELIVERY

M5 to M12 threaded mandrel and nosepiece

## ADVANTAGES

- Lightweight riveting gun
- Hose connection with quick-release coupling (on request): Disconnects the gun from the external pressure booster without oil loss and without venting
- Ideally suited for setting blind rivet nuts in difficult to access places
- Also ideal for installation in assembly cells, fixtures or semi-automatic workstations
- Can be equipped with almost all FireFox® 2 accessories: e.g. extension units, spent mandrel container, blind rivet nut counter, setting process monitoring, spring-loaded trigger system and remote control



242

Threaded mandrels and nosepieces analog to FireFox® 2 F page 242.

# **FIREREX<sup>®</sup>** as robot application



Integrated in a robot application, the FireRex<sup>®</sup> is capable of reliably setting blind rivet nuts, also hexagon, at any conceivable angle in industrial production processes. **Cost-effective**, innovative and fast, the new GESIPA<sup>®</sup> technology will revolutionise the industrial processing of blind rivet nuts.

**Detailed information on project implementation in your company is available from our Technical Sales department on request.**



# FIREREX<sup>®</sup> C WINTECH

The hydropneumatic blind rivet nut setting tool with external pressure booster and with setting process monitoring

Technical data, working range and advantages analog to FireRex<sup>®</sup> page 239.

## NOW ALSO AVAILABLE WITH SETTING PROCESS MONITORING!

In the production of critical components as well as in automatic setting processes, the FireRex<sup>®</sup> 2 C WinTech can facilitate monitoring and documentation of the results. The FireFox<sup>®</sup> 2 C WinTech is based on the proven TAURUS<sup>®</sup> C model. Here the setting process is analysed via integrated electronics using stroke and force sensors. The user can define an OK window by means of a special software. A coloured LED on the tool shows the results of the setting process monitoring which can also be recorded and processed via data line.

As a further development of the tried and tested FireFox<sup>®</sup> 2, the FireRex<sup>®</sup> is capable of setting blind rivet nuts at any conceivable angle in industrial production processes. The external pressure booster makes the FireRex<sup>®</sup> particularly suitable for use in tight spaces. The special gun of the FireRex<sup>®</sup> can be integrated in production systems and facilitates flexible and ergonomically efficient manual working procedures in applications with restricted access and therefore require riveting from above.



### EXAMPLE OF OK PROCESS

Window entry and exit at customer-defined positions

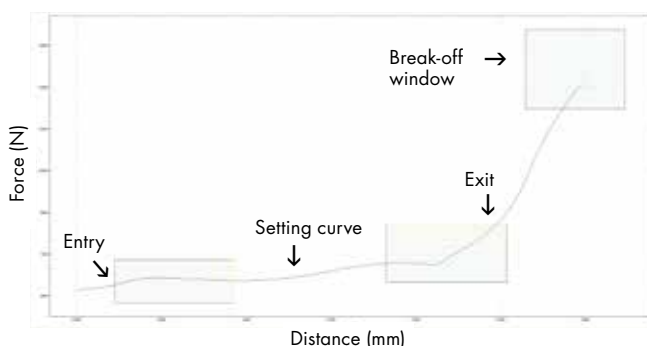

### EXAMPLE OF NOT OK PROCESS

Material to be joined too thin due to missing component

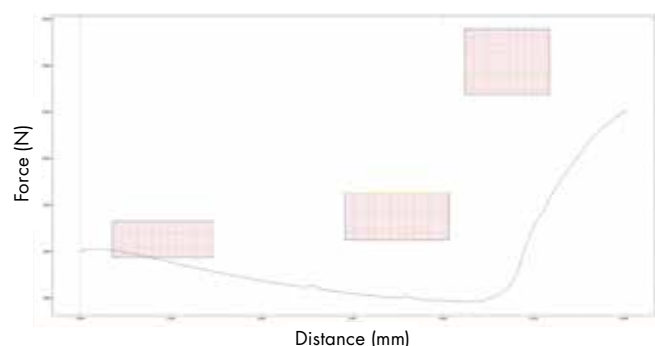

# SPECIAL ACCESSORIES / NOSEPIECES Blind rivet nut setting tools

## NOSEPIECES STANDARD

For the Fire Bird®, Fire Bird® Pro- and FireFox® series

Nosepiece	d Ø mm	D Ø mm	No. FireBird®	No. FireBird® Pro / FireBird® Pro GE / FireBird® Pro S GE	No. FireFox® 2, FireFox® 2 F FireFox® 2 FL	No. FireFox® 1 F
M3	3.2	7.0	<b>143 5065</b>	<b>143 6218</b>	-	<b>143 6218</b>
M4	4.2	8.0	<b>143 5066</b>	<b>143 6219</b>	<b>143 6219</b>	<b>143 6219</b>
M5	5.2	9.0	<b>143 5067</b>	<b>143 6220</b>	<b>143 6220</b>	<b>143 6220</b>
M6	6.2	11.0	<b>143 5068</b>	<b>143 6221</b>	<b>143 6221</b>	<b>143 6221</b>
M8	8.2	13.0	<b>143 5069</b>	<b>143 6222</b>	<b>143 6222</b>	-
M10	10.2	14.0	<b>143 5070</b>	<b>143 6223</b>	<b>143 6223</b>	-
M12	12.2	17.0	-	<b>143 6224*</b>	<b>143 6224</b>	-
6-32 UNC	3.7	7.0	<b>145 7461</b>	<b>143 6256</b>	<b>143 6256**</b>	<b>143 6256</b>
8-32 UNC	4.4	8.0	<b>143 5093</b>	<b>143 6257</b>	<b>143 6257**</b>	<b>143 6257</b>
10-24 UNC/10-32 UNF	5.0	9.0	<b>143 5094</b>	<b>143 6258</b>	<b>143 6258**</b>	<b>143 6258</b>
1/4"-20 UNC	6.5	11.0	<b>143 5095</b>	<b>143 6259</b>	<b>143 6259**</b>	-
5/16"-18 UNC	8.2	13.0	-	<b>143 6222</b>	<b>143 6222**</b>	-
3/8"-16 UNC	9.8	14.0	<b>145 7459</b>	<b>143 6261</b>	<b>143 6261**</b>	-

\*Does not apply to FireBird® Pro / FireBird® Pro S

\*\*Does not apply to FireFox® 2 FL

Other dimensions on request.

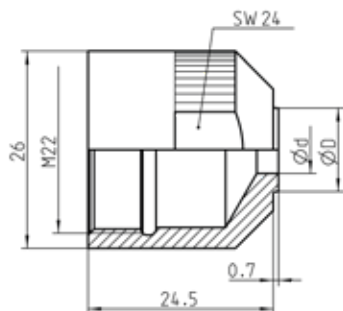

Standard nosepiece FireBird®

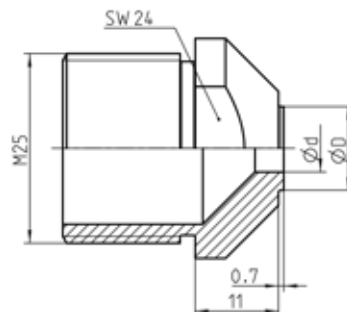

Standard nosepiece FireBird® Pro/FireFox®

## SPECIAL NOSEPIECES

For the Fire Bird<sup>®</sup>-, Fire Bird<sup>®</sup> Pro- and FireFox<sup>®</sup> series

Nosepiece	SL	d Ø mm	D Ø mm	No. FireBird <sup>®</sup>	No. FireBird <sup>®</sup> Pro / FireBird <sup>®</sup> Pro GE / FireBird <sup>®</sup> Pro S GE	No. FireFox <sup>®</sup> 2 , FireFox <sup>®</sup> 2 F	No. FireFox <sup>®</sup> 1 F
M3	SL10	3.2	7.0	-	<b>145 8149</b>	-	<b>145 8149</b>
	SL20			-	<b>145 8134</b>	-	<b>145 8134</b>
	SL30			<b>145 7470</b>	<b>143 6314</b>	-	<b>143 6314</b>
M4	SL10	4.2	8.0	-	<b>145 8150</b>	<b>145 8150</b>	<b>145 8150</b>
	SL20			-	<b>145 8135</b>	<b>145 8135</b>	<b>145 8135</b>
	SL30			<b>145 7469</b>	<b>143 6315</b>	<b>143 6315</b>	<b>143 6315</b>
M5	SL10	5.2	9.0	<b>145 7479</b>	<b>145 8151</b>	<b>145 8151</b>	<b>145 8151</b>
	SL20			<b>145 7478</b>	<b>145 8136</b>	<b>145 8136</b>	<b>145 8136</b>
	SL30			<b>145 7472</b>	<b>143 6316</b>	<b>143 6316</b>	<b>143 6316</b>
M6	SL10	6.2	11.0	<b>145 7481</b>	<b>145 8131</b>	<b>145 8131</b>	<b>145 8131</b>
	SL20			<b>145 7480</b>	<b>145 8137</b>	<b>145 8137</b>	<b>145 8137</b>
	SL30			<b>145 7473</b>	<b>143 6317</b>	<b>143 6317</b>	<b>143 6317</b>
M8	SL10	8.2	13.0	<b>145 7482</b>	<b>145 8152</b>	<b>145 8152</b>	-
	SL20			<b>145 7498</b>	<b>145 8138</b>	<b>145 8138</b>	-
	SL30			<b>145 7474</b>	<b>143 6318</b>	<b>143 6318</b>	-
M10	SL10	10.2	14.0	-	<b>145 8153</b>	<b>145 8153</b>	-
	SL20			-	<b>145 8139</b>	<b>145 8139</b>	-
	SL30			-	<b>143 6319</b>	<b>143 6319</b>	-
M12	SL10	12.2	17.0	-	<b>145 8154*</b>	<b>145 8154</b>	-
	SL20			-	<b>145 8140*</b>	<b>145 8140</b>	-
	SL30			-	<b>143 6320*</b>	<b>143 6320</b>	-

\*Does not apply to FireBird<sup>®</sup> Pro / FireBird<sup>®</sup> Pro S  
Other dimensions on request.

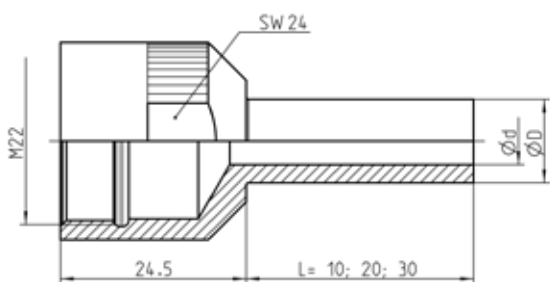

SL nosepiece FireBird<sup>®</sup>

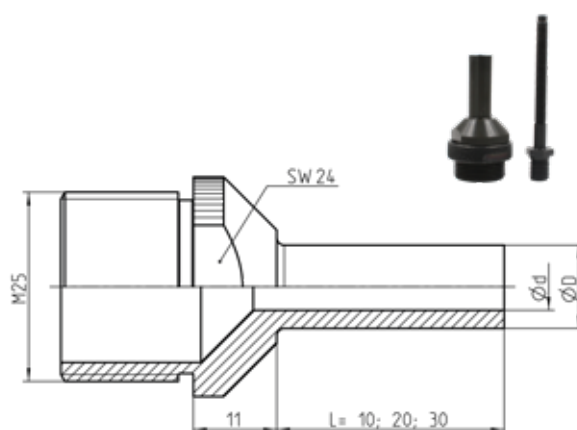

SL nosepiece FireBird<sup>®</sup> Pro/FireFox<sup>®</sup>

# SPECIAL ACCESSORIES / THREADED MANDRELS Blind rivet nut setting tools

## THREADED MANDRELS STANDARD

For the Fire Bird®, Fire Bird® Pro- and FireFox® series

Threaded mandrels	L1 mm	L2 mm	No. FireBird®	L1 mm	L2 mm	No. FireBird® Pro / FireBird® Pro GE / FireBird® Pro S GE	No. FireFox® 1F	No. FireFox® 2 FireFox® 2 F	No. FireFox® 2 FL
M3	13.5	17	<b>143 5052</b>	11	23	<b>143 6211</b>	<b>143 6211</b>	-	-
M4	15.5	19	<b>143 5055</b>	14.5	26.5	<b>143 6212</b>	<b>143 6212</b>	<b>143 6212</b>	<b>143 6364</b>
M5	16	19.5	<b>143 5056</b>	17	29	<b>143 6213</b>	<b>143 6213</b>	<b>143 6213</b>	<b>143 6365</b>
M6	20	23.5	<b>143 5059</b>	20.5	32.5	<b>143 6214</b>	<b>143 6214</b>	<b>143 6214</b>	<b>143 6366</b>
M8	21.5	25	<b>143 5063</b>	22	34	<b>143 6215</b>	-	<b>143 6215</b>	<b>143 6367</b>
M10	22	25.5	<b>143 5064</b>	23	35	<b>143 6216</b>	-	<b>143 6216</b>	<b>143 6368</b>
M12	-	-	-	30	42	<b>143 6217*</b>	-	<b>143 6217</b>	<b>143 6369</b>
6-32 UNC	15.5	19	<b>145 7460</b>	15	27	<b>143 6249</b>	<b>143 6249</b>	<b>143 6249</b>	-
8-32 UNC	15.5	19	<b>143 5090</b>	15	27	<b>143 6250</b>	<b>143 6250</b>	<b>143 6250</b>	-
10-24 UNC	19.5	23	<b>145 7475</b>	17.5	29.5	<b>143 6251</b>	<b>143 6251</b>	<b>143 6251</b>	-
10-32 UNF	19.5	23	<b>143 5091</b>	16	28	<b>143 6252</b>	<b>143 6252</b>	<b>143 6252</b>	-
1/4"-20 UNC	24	27.5	<b>143 5092</b>	24	36	<b>143 6253</b>	-	<b>143 6253</b>	-
5/16"-18 UNC	27.5	31	<b>145 7457</b>	28	40	<b>143 6254</b>	-	<b>143 6254</b>	-
3/8"-16 UNC	30.5	34	<b>145 7458</b>	29	41	<b>143 6255</b>	-	<b>143 6255</b>	-

\*Does not apply to FireBird® Pro  
Other dimensions on request.

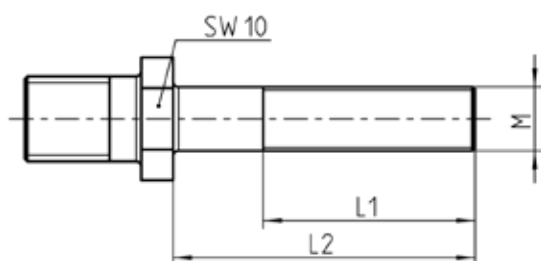

Standard threaded mandrel FireBird®

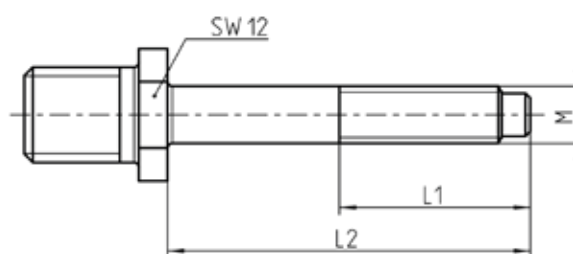

Standard threaded mandrel FireBird® Pro/FireFox®

## SPECIAL THREADED MANDRELS

For the Fire Bird<sup>®</sup>-, Fire Bird<sup>®</sup> Pro- and FireFox<sup>®</sup> series

Threaded mandrels	SL	L2 mm	No. FireBird <sup>®</sup>	SL	L2 mm	No. FireBird <sup>®</sup> Pro / FireBird <sup>®</sup> Pro GE / FireBird <sup>®</sup> Pro S GE	No. FireFox <sup>®</sup> 2 / FireFox <sup>®</sup> 2 F	No. FireFox <sup>®</sup> 1F
M3	SL10	-	-	SL10	33	<b>145 8156</b>	-	<b>145 8156</b>
	SL20	-	-	SL20	43	<b>145 8141</b>	-	<b>145 8141</b>
	SL30	47	<b>145 7471</b>	SL30	53	<b>143 6325</b>	-	<b>143 6325</b>
M4	SL10	-	-	SL10	36.5	<b>145 8157</b>	<b>145 8157</b>	<b>145 8157</b>
	SL20	-	-	SL20	46.5	<b>145 8142</b>	<b>145 8142</b>	<b>145 8142</b>
	SL30	49	<b>145 7464</b>	SL30	56.5	<b>143 6326</b>	<b>143 6326</b>	<b>143 6326</b>
M5	SL10	29.5	<b>145 7484</b>	SL10	39	<b>145 8158</b>	<b>145 8158</b>	<b>145 8158</b>
	SL20	39.5	<b>145 7483</b>	SL20	49	<b>145 8143</b>	<b>145 8143</b>	<b>145 8143</b>
	SL30	49.5	<b>145 7465</b>	SL30	59	<b>143 6327</b>	<b>143 6327</b>	<b>143 6327</b>
M6	SL10	33.5	<b>145 7486</b>	SL10	42.5	<b>145 8132</b>	<b>145 8132</b>	<b>145 8132</b>
	SL20	43.5	<b>145 7485</b>	SL20	52.5	<b>145 8144</b>	<b>145 8144</b>	<b>145 8144</b>
	SL30	53.5	<b>145 7466</b>	SL30	62.5	<b>143 6328</b>	<b>143 6328</b>	<b>143 6328</b>
M8	SL10	35	<b>145 7488</b>	SL10	44	<b>145 8159</b>	<b>145 8159</b>	-
	SL20	45	<b>145 7487</b>	SL20	54	<b>145 8145</b>	<b>145 8145</b>	-
	SL30	55	<b>145 7467</b>	SL30	64	<b>143 6329</b>	<b>143 6329</b>	-
M10	SL10	-	-	SL10	45	<b>145 8160</b>	<b>145 8160</b>	-
	SL20	-	-	SL20	55	<b>145 8146</b>	<b>145 8146</b>	-
	SL30	-	-	SL30	65	<b>143 6330</b>	<b>143 6330</b>	-
M12	SL10	-	-	SL10	52	<b>145 8161*</b>	<b>145 8161</b>	-
	SL20	-	-	SL20	62	<b>145 8147*</b>	<b>145 8147</b>	-
	SL30	-	-	SL30	72	<b>143 6331*</b>	<b>143 6331</b>	-
6-32 UNC	SL10	-	-	SL10	37	<b>145 1069</b>	<b>145 1069</b>	-
	SL20	-	-	SL20	47	<b>145 1059</b>	<b>145 1059</b>	-
	SL30	-	-	SL30	57	<b>143 6332</b>	<b>143 6332</b>	-
8-32 UNC	SL10	-	-	SL10	37	<b>145 8162</b>	<b>145 8162</b>	-
	SL20	-	-	SL20	47	<b>145 1060</b>	<b>145 1060</b>	-
	SL30	-	-	SL30	57	<b>143 6333</b>	<b>143 6333</b>	-
10-24 UNC	SL10	-	-	SL10	39.5	<b>145 1070</b>	<b>145 1070</b>	-
	SL20	-	-	SL20	49.5	<b>145 1061</b>	<b>145 1061</b>	-
	SL30	-	-	SL30	59.5	<b>143 6334</b>	<b>143 6334</b>	-
10-32 UNF	SL10	-	-	SL10	38	<b>145 1071</b>	<b>145 1071</b>	-
	SL20	-	-	SL20	48	<b>145 1062</b>	<b>145 1062</b>	-
	SL30	-	-	SL30	58	<b>143 6335</b>	<b>143 6335</b>	-
1/4"-20 UNC	SL10	-	-	SL10	46	<b>145 1072</b>	<b>145 1072</b>	-
	SL20	-	-	SL20	56	<b>145 1063</b>	<b>145 1063</b>	-
	SL30	-	-	SL30	66	<b>143 6336</b>	<b>143 6336</b>	-
5/16"-18 UNC	SL10	-	-	SL10	50	<b>145 1073</b>	<b>145 1073</b>	-
	SL20	-	-	SL20	60	<b>145 8148</b>	<b>145 8148</b>	-
	SL30	-	-	SL30	70	<b>143 6337</b>	<b>143 6337</b>	-
3/8"-16 UNC	SL10	-	-	SL10	51	<b>145 1074</b>	<b>145 1074</b>	-
	SL20	-	-	SL20	61	<b>145 1064</b>	<b>145 1064</b>	-
	SL30	-	-	SL30	71	<b>143 6338</b>	<b>143 6338</b>	-

\*Does not apply to FireBird<sup>®</sup> Pro  
Other dimensions on request.

# RETAILER AREA / POINT OF SALE

## RETAILER AREA

The good cooperation between GESIPA® and our partners in distribution and retail has become indispensable. This loyalty to retailers makes it essential that we train our partners regularly and support them with material and information for sales.

In this area we keep our trading partners up to date about upcoming sales promotions or exhibition appointments. You can also find out how we support you in terms of eCommerce, product data, flyer, brochures or with our image database.

On our service portal you will find many information:



<https://en.gesipa.de/service/>



<https://en.gesipa.de/retailer/>

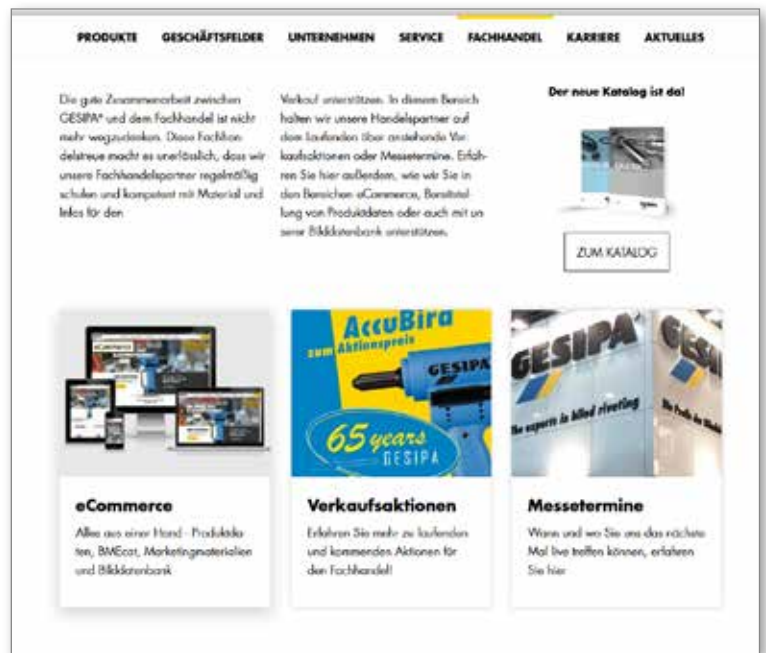

## RIVET HANDBOOK

**The ideal companion for the GESIPA® „Do-it-yourself“ product range.**

With GESIPA® blind rivet technology, both large and small objects in the home can be repaired in next to no time.

The Rivet Handbook explains the advantages of blind rivet technology by means of easily understandable examples. Figures illustrate the range of possible applications for rivets as well as the setting procedure using the corresponding tools.



# POINT OF SALE

## SALES WALL

The GESIPA® sales wall guarantees the highest level of attention in specialist stores.

All GESIPA® fast turners are professionally and clearly presented on a sales wall that promotes sales. Using light boxes, attention is skilfully drawn to the GESIPA® logo, which serves as an eye-catcher for the customers. The light boxes are suitable for the TEGOMETALL racking system.

Prices and additional information are available on request. The GESIPA® sales team will be happy to advise you!



## IN-HOUSE TRADE FAIRS

**GESIPA® will gladly take part in your in-house trade show.**

In the retail sector information is just as important as the products themselves. Due to the wide range of products available on the market, many products are no longer self-explanatory, and hence experience sharing and a relationship based on trust are becoming increasingly important.

Establishing contacts is very important and, traditionally, this takes place at trade fairs when talking to business partners.

Just contact us and we will be happy to come to your in-house trade fair!



# DO IT YOURSELF

## NTS Hand riveter

For easy setting blind rivets.

- Narrow head for difficult to access rivet locations
- Opening spring for automatic ejection of the mandrel
- Ergonomic handles



No. 143 4029

## NIETBOY

The handyman's riveting kit including NTS hand riveter and a selection of 100 rivets, washers and a drill.



No. 143 5461

## BLIND RIVET ASSORTMENT

### CONTENTS

100 blind rivets  
in alu/steel:  
4 mm Ø x 6, x 8, x 12



No. 143 3667



## GBM 5 Blind rivet nut tool

- Easy stroke adjustment
- Quick exchange of mandrel

Sets blind rivet nuts from M4 bis M6 Alu and up to M5 steel and stainless steel.

**Content:** 15 x M5 Alu, threaded mandrel M4 and M5, M6 in working position, 1 maintenance wrench



No. 143 4803

## BLIND RIVET NUT ASSORTMENT

No. 143 3675

### CONTENTS

Each one threaded mandrel M4 and M5 for NTS and NTX.

Each 8 blind rivet nuts M4 short and long.

Each 8 blind rivet nuts M5 short and long.



## SERVICE-PACK

No. 143 3668

### CONTENTS

50 pcs. of washers 3.1 and 4.1 mm Ø and one of drills 3.1 and 4.1 mm Ø





# MINI-PACKS

## MINI-PACK BLIND RIVETS

18 of the most popular blind rivet sizes in **alu/steel**, **steel/steel** and **copper/bronze** in single boxes.



### Alu/steel

D x L mm		No.	
3 x 6	2.5 - 3.5	143 3530	100
3 x 8	4.5 - 5.0	143 3531	100
3 x 12	7.0 - 9.0	143 3532	100
4 x 6	1.5 - 3.0	143 3533	100
4 x 8	4.0 - 5.0	143 3534	100
4 x 12	6.5 - 8.5	143 3535	100
5 x 6	2.0 - 2.5	143 3536	50
5 x 10	4.5 - 6.0	143 3537	50
5 x 12	6.0 - 8.0	143 3538	50

### Copper/bronze

4 x 6	0.5 - 3.5	143 3662	50
4 x 10	4.5 - 6.5	143 3663	50
4 x 12	6.5 - 8.5	143 3664	50



### Steel/steel

3 x 6	2.0 - 3.0	143 3568	100
3 x 10	5.0 - 6.5	143 3569	100
3 x 12	6.5 - 8.5	143 3570	100
4 x 6	0.5 - 2.5	143 3571	100
4 x 10	4.5 - 6.5	143 3572	100
4 x 12	6.5 - 8.5	143 3573	100

## BLIND RIVET NUTS BLISTERED

GBM mini pack blind rivet nuts in **alu** on blister card.

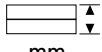

Description	d <sub>h</sub> mm		No.	
M4	6.1	0.25 - 3.0	143 3669	20
M4	6.1	2.5 - 4.5	143 3670	20
M5	7.1	0.25 - 3.0	143 3671	15
M5	7.1	2.5 - 5.0	143 3672	15
M6	9.1	0.25 - 3.5	143 3673	8
M6	9.1	3.0 - 5.5	143 3674	7

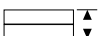

d<sub>h</sub> = hole-Ø in mm

 = Grip range

# MINI-PACKS

## MINI PACK POLYGRIP® BLIND RIVETS

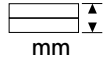
### PolyGrip® alu/steel



D x L mm	 mm	No.	
3.2 x 8	0.5 - 5.0	143 3846	100
3.2 x 11	3.0 - 8.0	143 3847	100
4 x 10	0.5 - 6.5	143 3848	100
4 x 17	7.0 - 13.0	143 3849	50
4.8 x 10	0.5 - 6.5	143 3850	50
4.8 x 17	6.5 - 13.0	143 3851	50

### PolyGrip® alu/stainless steel

3.2 x 8	0.5 - 5.0	146 4835	100
3.2 x 11	3.0 - 8.0	146 4834	100
4 x 10	0.5 - 6.5	146 4831	100
4 x 17	7.0 - 13.0	143 2059	50
4.8 x 10	0.5 - 6.5	146 4833	50
4.8 x 17	6.5 - 13.0	146 4832	50

Material surcharge will be added at a daily rate.

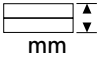
### PolyGrip® steel/steel

D x L mm	 mm	No.	
3.2 x 8	1.0 - 5.0	146 4887	100
3.2 x 11	3.0 - 8.0	146 4886	100
4 x 10	1.5 - 6.5	146 4884	100
4 x 13	4.5 - 9.0	146 4883	50
4.8 x 10	1.5 - 6.5	143 2058	50
4.8 x 15	6.0 - 11.0	146 4885	50

### PolyGrip® stainless steel

3.2 x 8	1.0 - 5.0	143 2060	100
3.2 x 11	3.0 - 8.0	146 4830	75
4 x 10	1.0 - 6.5	146 4827	75
4 x 17	7.0 - 11.0	146 4826	50
4.8 x 10	1.0 - 6.5	146 4829	50
4.8 x 15	5.0 - 10.0	146 4828	50



Material surcharge will be added at a daily rate.

### PolyGrip® alu/steel large flange K16

4.8 x 10	0.5 - 6.5	143 3852	25
4.8 x 17	6.5 - 13.0	143 3853	25

## MINI PACK POLYGRIP® BLIND RIVET NUTS

### POLYGRIP® Alu

Description	d <sub>h</sub> mm	 mm	No.	
M 5	7.1	0.25 - 5.0	146 4843	50
M 6	9.1	0.25 - 6.0	146 4842	25
M 8	11.1	0.5 - 6.5	146 4841	25

### PolyGrip® steel

M 5	7.1	0.25 - 5.0	146 4840	50
M 6	9.1	0.25 - 6.0	146 4839	25
M 8	11.1	0.5 - 6.5	146 4915	25

### PolyGrip® A2 stainless steel

M 5	7.1	0.25 - 5.0	146 4888	50
M 6	9.1	0.25 - 6.0	146 4838	25
M 8	11.1	0.5 - 6.5	146 4837	25



Material surcharge will be added at a daily rate.

d<sub>h</sub> = hole-Ø in mm

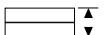
 = Grip range

Valid from 1 March 2021



# SPARE PARTS 2021 / 22

A member of **SFS**

**GESIPA**<sup>®</sup>  

# TABLE OF CONTENTS

## BLIND RIVET HAND TOOLS

NTX and NTX-F (with self opening spring) .....	255
Flipper® .....	256
Flipper® Plus .....	257
HN 2 / HN 2-BT (only for Bulb-tite®) .....	258
SN 2 .....	259
AccuBird® .....	260
PowerBird® - tool no longer available .....	262
AccuBird® Pro - until april 2021 .....	264
AccuBird® Pro with new CAS technology - from may 2021 .....	266
PowerBird® Pro - tool no longer available .....	268
PowerBird® Pro Gold Edition - until april 2021 .....	270
PowerBird® Pro Gold Edition with new CAS technology - from may 2021 .....	272
iBird® Pro - until april 2021 .....	274
iBird® Pro with new CAS technology - from may 2021 .....	276
Bird Pro series with spring loaded trigger system .....	278
Spring loaded trigger system for Bird series .....	279
AccuBird® and PowerBird® angle head 90° compact .....	280

## ACCESSORIES FOR BATTERY POWERED BLIND RIVET SETTING TOOLS

One-piece extension units .....	281
Multi-piece extension units .....	283

## HYDRO-PNEUMATIC BLIND RIVET SETTING TOOLS

TAURUS® 1-4 .....	284
TAURUS® 5-6 .....	286
TAURUS® 1-4 AV .....	288

## ACCESSORIES FOR HYDRO-PNEUMATIC BLIND RIVET SETTING TOOLS

Repair tools .....	290
Changeover set spent mandrel container .....	290
Rivet counter sensor changeover set for TAURUS® 1-4 .....	290
One-piece extension units .....	291
Multi-piece extension units .....	293
Heads for TAURUS® 5-6 .....	293
Angle heads for TAURUS® blind rivet setting tools .....	294

## HYDRO-PNEUMATIC BLIND RIVET SETTING TOOLS

TAUREX 1-4 .....	296
TAUREX 5-6 .....	298
TAURUS® 1-4 Axial eco .....	300
TAURUS® 1-4 Axial .....	302
TAUREX 1-4 Axial .....	304
Spring loaded trigger system for Taurus® 1-4 Axial eco .....	306
Spring loaded trigger system for Taurus® 1-4 Axial .....	307
Taurus® 1 Speed Rivet / Taurus® 2 Speed Rivet .....	308
Taurus® 1 Speed Rivet Axial eco / Taurus® 2 Speed Rivet Axial eco .....	310
PH 1 and PH 2 .....	312
PH Axial .....	313

## SPECIAL ACCESSORIES FOR HYDRO-PNEUMATIC BLIND RIVET SETTING TOOLS

VAS for PH 1 and PH 2 .....	314
Angle head for PH 1 and PH 2 .....	314
Small jaw assembly for PH 1 and PH 2 .....	315
Small jaw assembly for PH 2000 .....	315
Small jaw assembly for PH-Axial .....	316
Spent mandrel container for PH-Axial .....	316
PH1/PH2 extension unit 100 mm .....	317
PH 2000 extension unit 100 mm .....	317

## LOCKBOLT SETTING TOOLS

TAURUS® 4 SRB with angle head 90° .....	318
TAURUS® 3 SRB / TAURUS® 4 SRB .....	320

# TABLE OF CONTENTS

## BLIND RIVET HAND NUT SETTING TOOLS

GBM 5 .....	322
GBM 10 .....	323
GBM 40-R .....	324
GBM 50 .....	325
FireFly .....	326
Flipper® Plus .....	327

## BATTERY POWERED BLIND RIVET NUT SETTING TOOLS

FireBird® .....	328
FireBird® Pro and FireBird® Pro Gold Edition - until april 2021 .....	330
FireBird® Pro with new CAS technology - from may 2021 .....	332
FireBird® Pro Gold Edition with new CAS technology - from may 2021 .....	334
FireBird® Pro S Gold Edition - until april 2021 .....	336
FireBird® Pro S Gold Edition with new CAS technology - from may 2021 .....	338

## HYDRO-PNEUMATIC BLIND RIVET NUT SETTING TOOLS

FireFox® 1 .....	340
FireFox® 1 F .....	342
FireFox® 2 .....	344
FireFox® 2 F .....	346
FireFox® 2 F L .....	348
FireFox® 1 F Axial eco .....	350
FireFox® 2 F Axial eco .....	352
Repair tools for FireFox® 1 F, 2, 2 F .....	354

<b>SPARE PART KITS</b> .....	355
------------------------------	-----

## LEGEND



Description

No.

Article no.



Position



Tool type



Mandrel diameter

# BLIND RIVET HAND TOOLS

## NTX and NTX-F (with self opening spring)

No.		
143 4055*	NTX	Nosepiece 10/18
143 4061*		Nosepiece 10/24
143 4062*	NTX-F	Nosepiece 10/27
143 4065*		Nosepiece 10/32
143 4070		Jaw housing
143 4071*		Jaws (2-part)
143 4072*		Jaw pusher
143 4073		Closure screw
143 4074		Lever
143 4075		Bolt
143 4076		Bolt
143 4095	NTX-F	Strap
143 4241		Hard jaws (2-part) for CAP® blind rivets
144 5258*	NTX	Compression spring
144 5259		Snap ring
144 5260*	NTX-F	Compression spring
144 5261*	NTX-F	Self opening spring
145 6624	NTX	Tool housing with sleeve grip
145 6625	NTX	Tool shanks with sleeve grip
145 6626	NTX-F	Tool housing with sleeve grip
145 6627	NTX-F	Tool shanks with sleeve grip

 You will find detailed nosepiece allocation tables on page 128.

\* Wearing parts

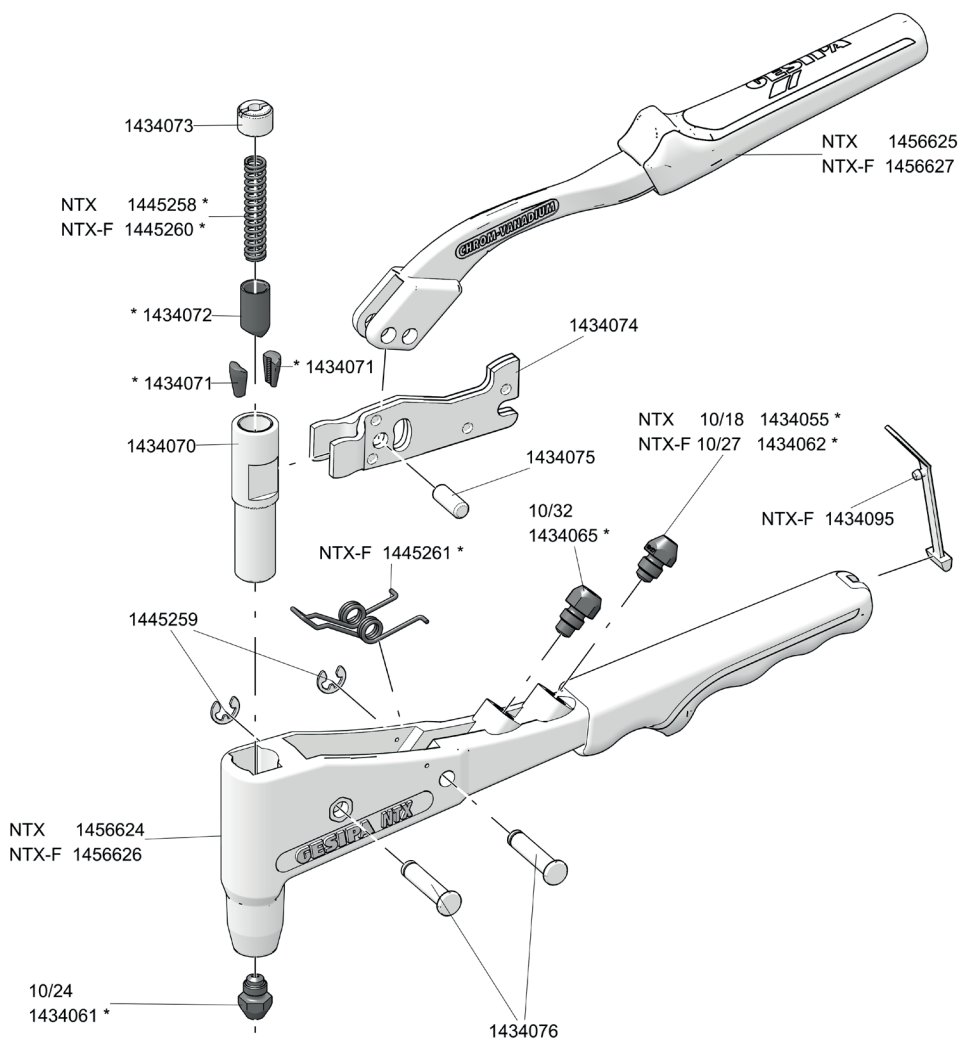

\* Wearing parts

# BLIND RIVET HAND TOOLS

## Flipper®

No.	
143 3959*	Jaw housing
143 3963	Housing with slide block, lever and grip
143 3965	Head
143 3966	Closure screw
143 3967	Pivot bolt
143 3968	Snap ring
143 3969	Lock activator
143 3970*	Jaw pusher
143 3971*	Compression spring
143 3972*	Return spring
143 3974	Drive pawl
143 3975	Storage finger (3-part) per set
143 3976	Bolt
143 3977*	Self opening spring
143 3978*	Retaining spring
143 3979	Spring dowel sleeve
143 3980	Maintenance wrench SW 10
143 3981*	O-ring for jaw housing
143 4055*	Nosepiece
143 4061*	Nosepiece
143 4064*	Nosepiece
143 4071*	Jaws (2-part) per set
145 6591	Betätigungshebel mit Stulpgriff
145 6592	Operating lever with sleeve grip

### \* Wearing parts

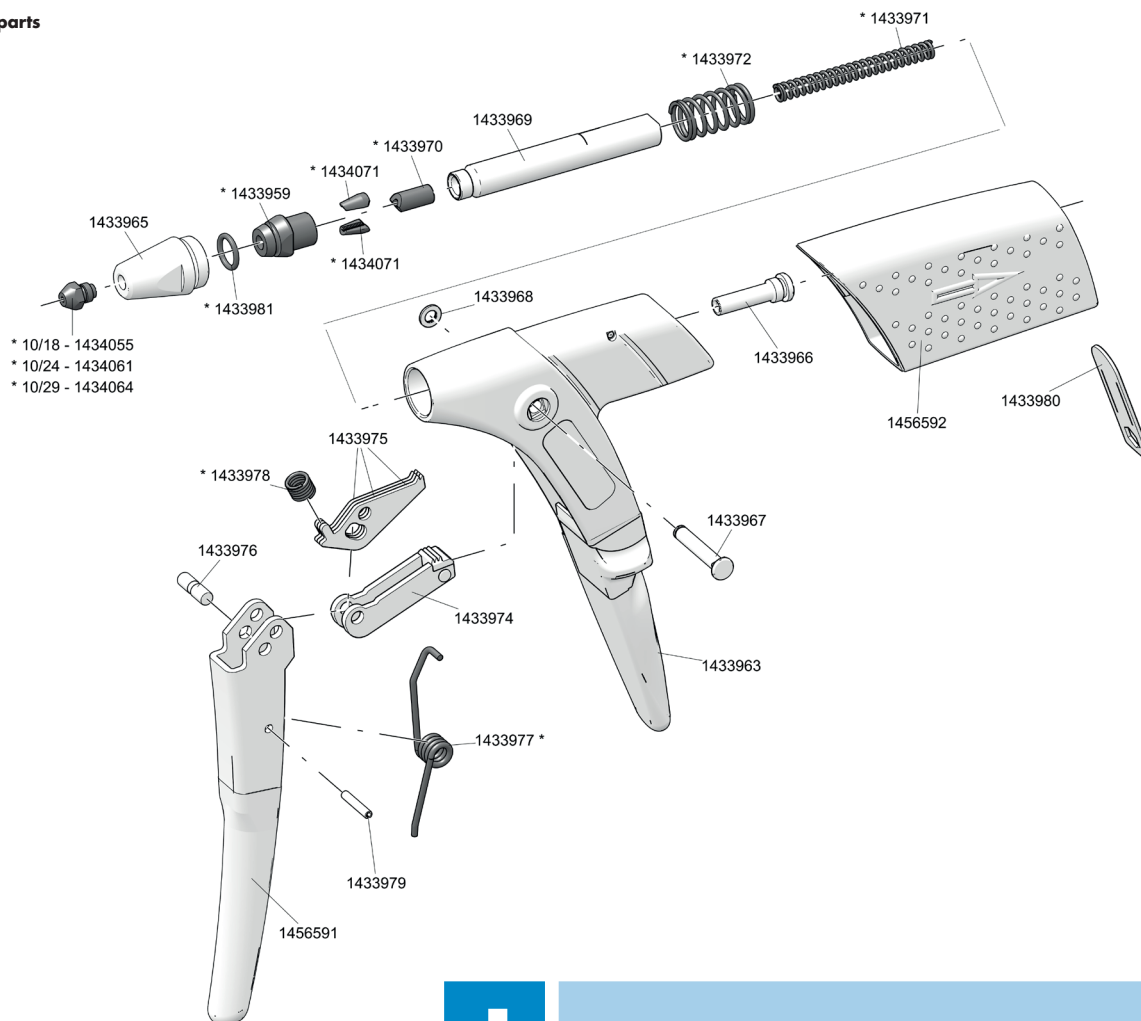

## Changeover set for plastic blind rivets

No.		
10/30 K*	143 4092	Nosepiece
10/35 K*	143 4093	Nosepiece
10/40 K*	143 4094	Nosepiece
17 K*	143 4086	Jaws (2-part) per set
18 K	143 3982	Jaw pusher
24 K	143 3983	Closure screw
	<b>143 3984</b>	<b>Changeover set complete</b>

### \* Wearing parts

 You will find detailed nosepiece allocation tables on page 128.

### \* Wearing parts



# BLIND RIVET HAND TOOLS

## Flipper® Plus

No.	
143 3959*	Jaw housing
143 3967	Pivot bolt
143 3968	Snap ring
143 3969	Lock activator
143 3970*	Jaw Pusher
143 3971*	Compression spring
143 3972*	Compression spring
143 3974	Drive pawl
143 3975	Storage finger (3-part) per set
143 3976	Bolt
143 3977*	Self opening spring
143 3978*	Retaining spring
143 3979	Spring dowel sleeve
143 3981*	O-ring
143 4071*	Jaws [2-part]
157 2917	Assembly aid
157 2918	Assembly key

No.	
157 2920*	Nosepiece 12/20
157 2924*	Nosepiece 12/24
157 2925*	Nosepiece 12/29
157 2926*	Nosepiece M4
157 2927*	Nosepiece M5
157 2929*	Nosepiece M6
157 2931	Closure screw
157 2932	Steel head sleeve
157 3064	Spent mandrel container
157 3065*	Draw bar M4
157 3066*	Draw bar M5
157 3067*	Draw bar M6
157 3068*	Jaw mechanism
157 3069*	Jaw mechanism
157 6258	Housing with slide block, lever and grip
158 3766	Hexagon key
166 8829	Actuating lever

### \* Wearing parts

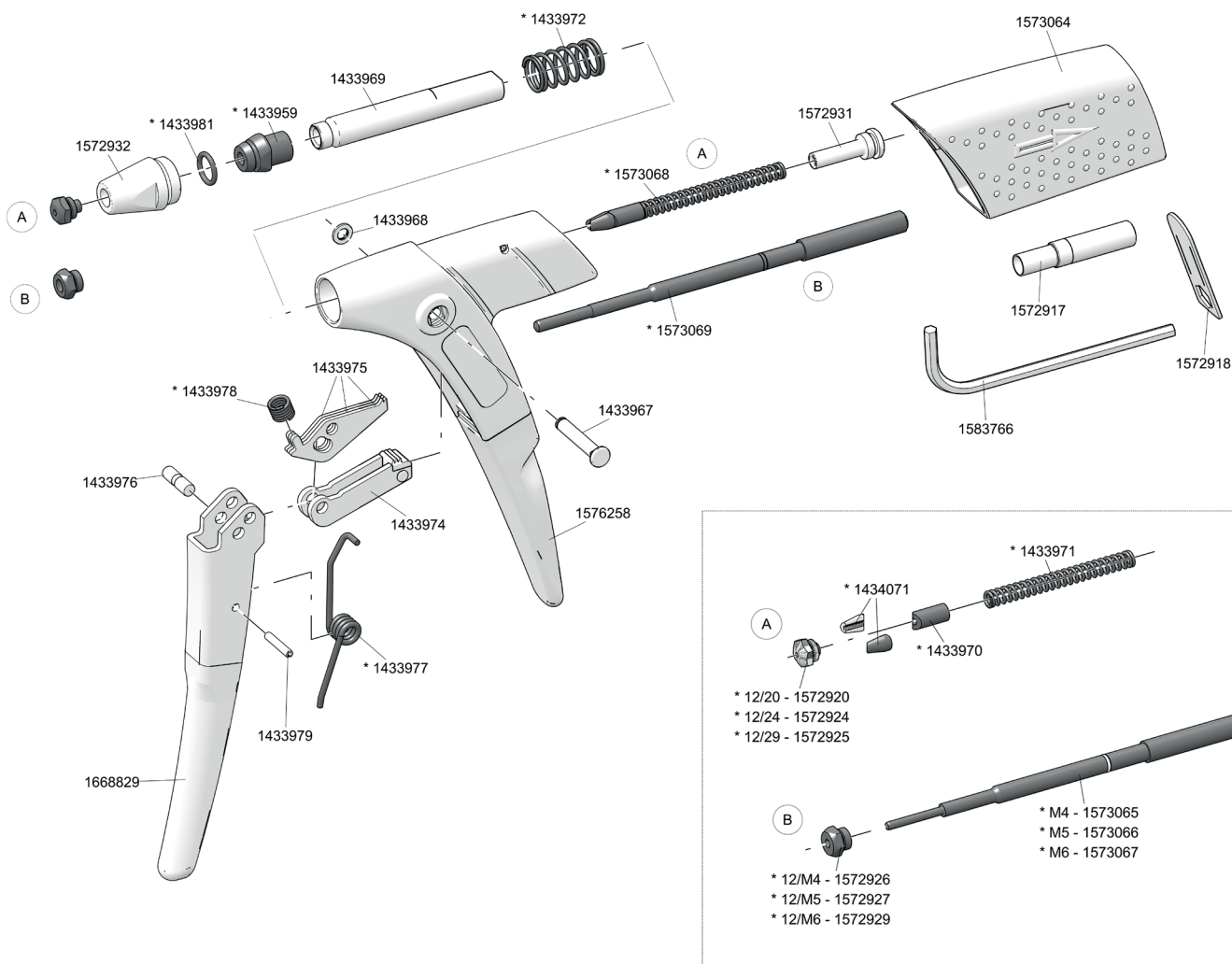

 You will find detailed nosepiece allocation tables on page 128.

\* Wearing parts

# BLIND RIVET HAND TOOLS

## HN 2 / HN 2-BT (only for BULB-TITE®)

No.	
143 4103*	Jaws (3-part) per set
143 4105	Head
143 4106	Jaw pusher
143 4124	Grip
143 4125	Transmission segment
143 4126	Gear rack
143 4127	Bolt
143 4128	Safety bolt
143 4129*	Jaw housing
143 4173*	Jaws BT
143 4290*	Nosepiece 16/29
143 4291*	Nosepiece 16/32
143 4292*	Nosepiece 16/36
143 4293*	Nosepiece 16/40
143 4300*	Nosepiece 16/45
143 4301*	Nosepiece for 4 mm Ø BULB-TITE® rivets
143 4302*	Nosepiece for 5.2 mm Ø BULB-TITE® rivets
143 4303*	Nosepiece for 6.3 mm Ø BULB-TITE® rivets
143 4304*	Nosepiece for 7.7 mm Ø BULB-TITE® rivets
144 5263*	Compression spring
144 5264	Cylinder pin
145 6717	Housing with, lever and grip
145 6718	Operating lever with pinion and grip
145 6719	End block with guide tube
145 6720	Spent mandrel container

 You will find detailed nosepiece allocation tables on page 129.

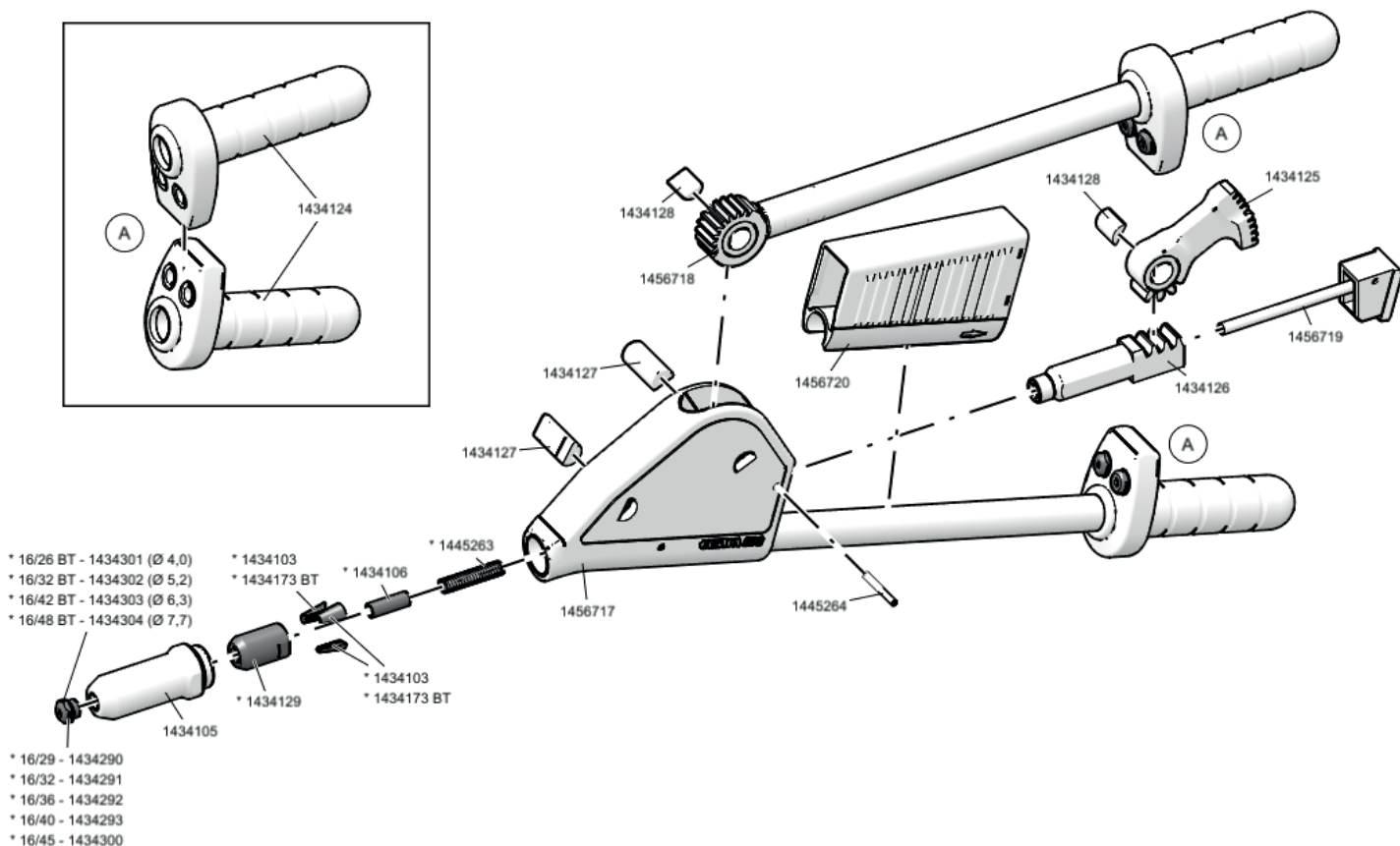

\* Wearing parts



\* Wearing parts

# BLIND RIVET HAND TOOLS

## SN 2

	No.	
1	145 6687	Housing
2	145 6688	Head
3	145 6689	Jaw housing
4 *	143 4958	Jaws (3-part)
5 *	145 6690	Jaw pusher
6 *	145 6691	Compression spring
7	145 6692	Locking nut
8	145 6693	Lock activator
10	145 6694	Sleeve, long
11	145 6695	Arm
12	145 6696	Lazy tongue segment, long
13	145 6697	Lazy tongue segment, short
14	145 6698	Grip
15	145 6699	Bolt
16	145 6700	Screw M6 x 37
17	145 6701	Screw M6 x 29
18	145 6702	Screw M5 x 29
19	145 6703	Screw M5 x 20.5
20	145 6704	Outer sleeve
21	145 6705	Inner sleeve
22	145 6706	Washer 6 x 1.8
23	145 6707	Washer 5 x 1.8
24	145 6708	Washer 6 x 12 x 1.0
25	145 6709	Washer 5 x 0.9
26	145 6710	Washer 5 x 0.5
27	144 5262	Nut M6
28	145 0574	Snap ring
29	145 6711	Nut M5
30	145 6712	Washer 6 x 9 x 0.7
31	145 6713	Washer 6 x 0.5
32 *	143 4955	Nosepiece 17/24
33 *	143 4973	Nosepiece 17/27
34 *	143 4974	Nosepiece 17/29
35 *	143 4975	Nosepiece 17/32
36 *	143 4977	Nosepiece 17/36
37 *	143 4999	Nosepiece 17/40
38 *	143 4860	Nosepiece 17/45

 You will find detailed nosepiece allocation tables on page 130.

\* Wearing parts

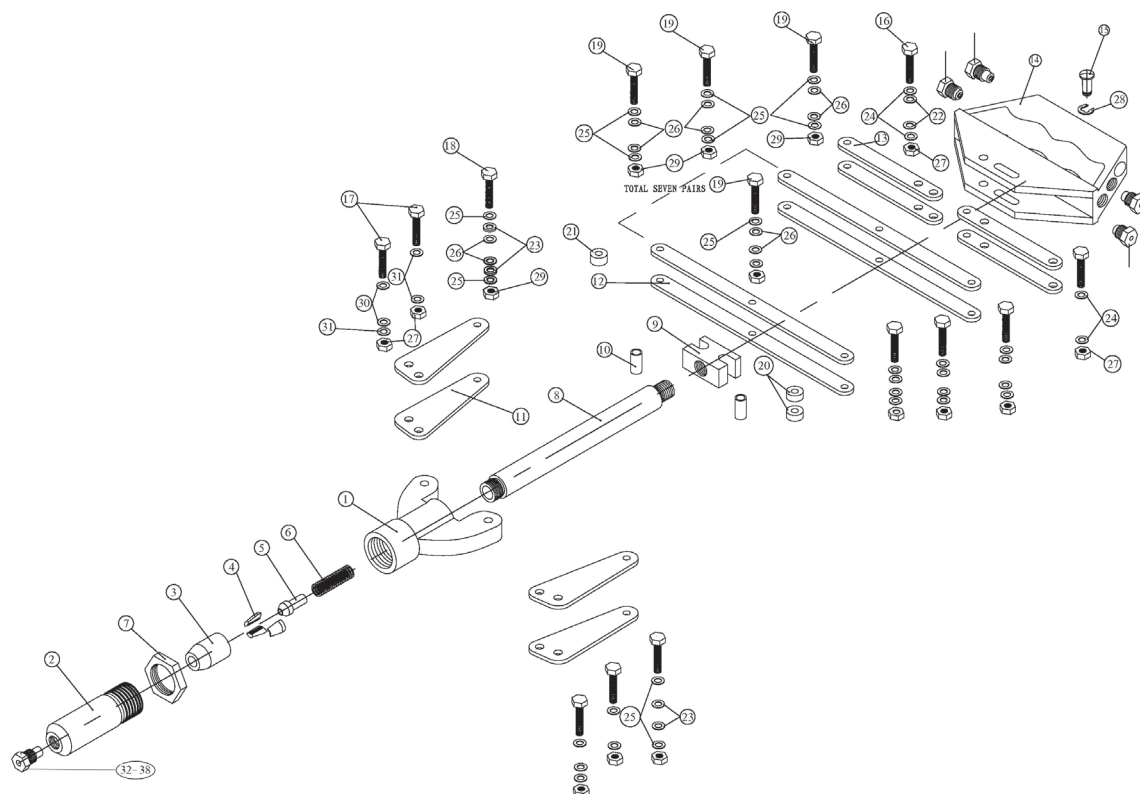

# BATTERY POWERED BLIND RIVET SETTING TOOLS

**AccuBird®**

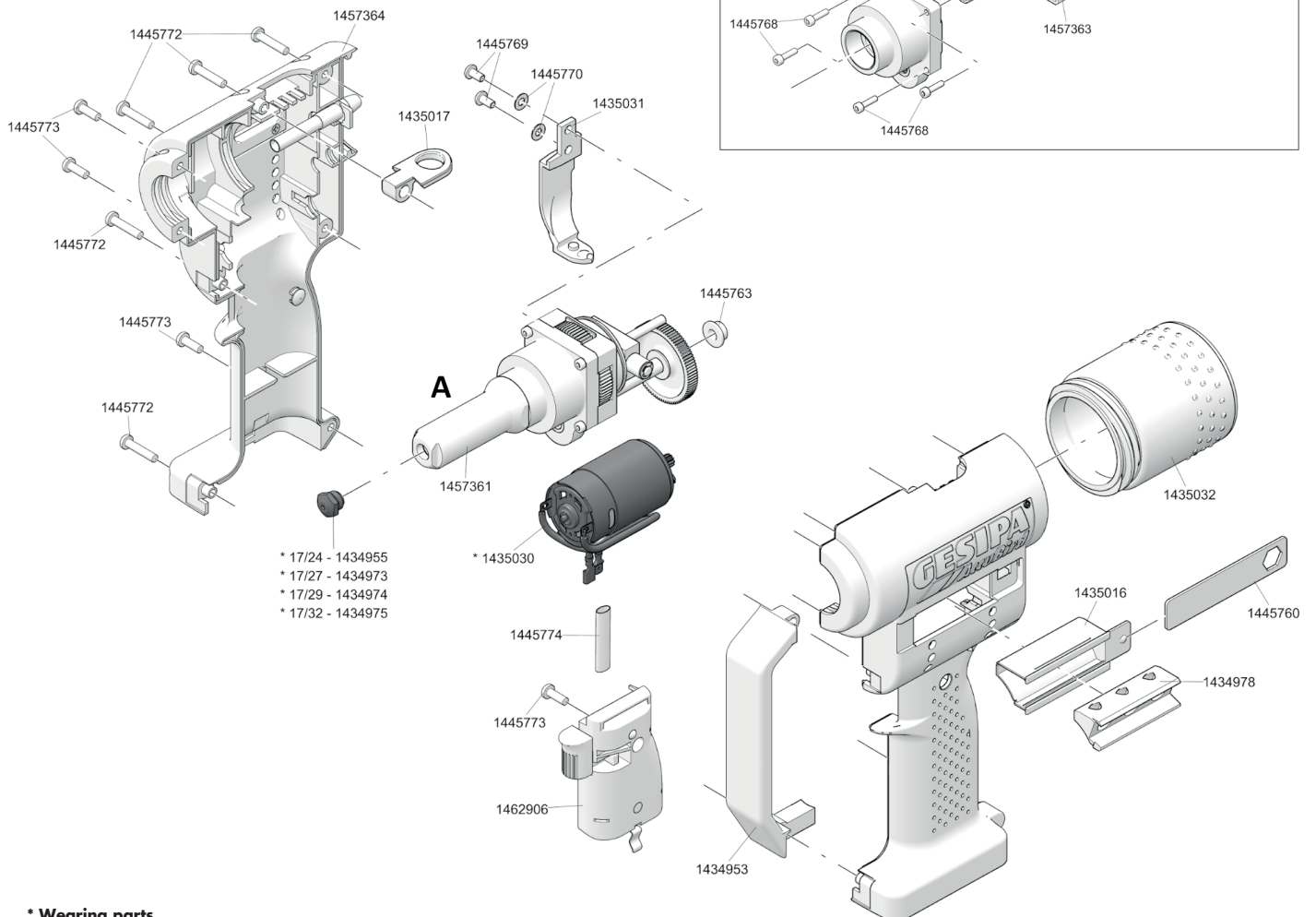
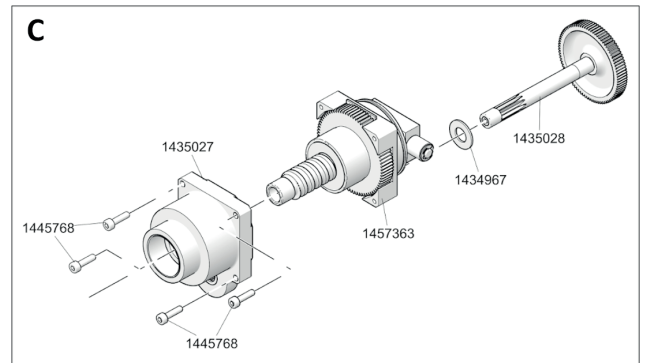
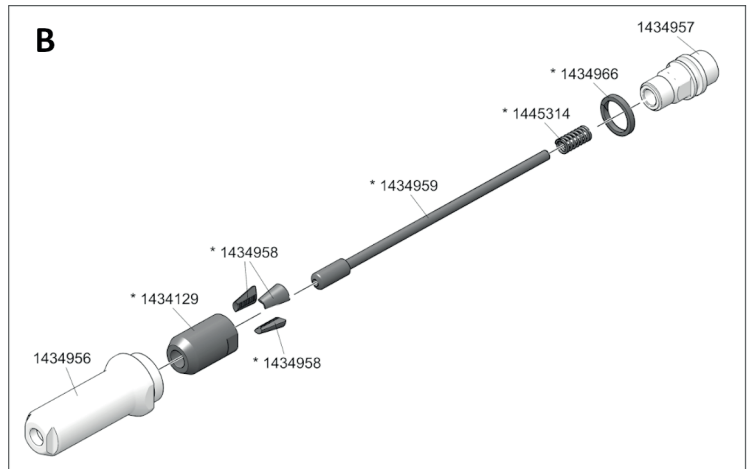
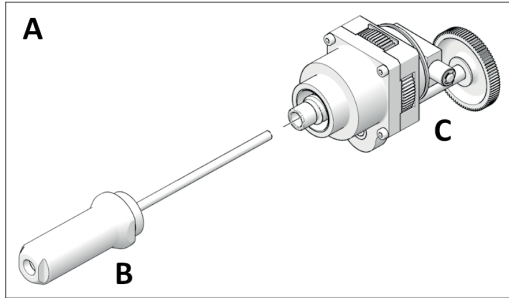

\* Wearing parts

# BATTERY POWERED BLIND RIVET SETTING TOOLS

## AccuBird®

No.	
143 4129*	Jaw housing
143 4953	Protection bracket
143 4955*	Nosepiece 17/24
143 4956	Head
143 4957	Adapter
143 4958*	Jaws (3-part)
143 4959*	Jaw Pusher
143 4966*	Wiper
143 4967	Stop disc
143 4973*	Nosepiece 17/27
143 4974*	Nosepiece 17/29
143 4975*	Nosepiece 17/32
143 4978	Magazine insert
143 5016	Nosepiece magazine
143 5017	Hanger
143 5027	Bearing, complete
143 5029	Pinion shaft, complete

No.	
143 5030*	Motor, complete
143 5031	Magnetic holder, complete
143 5032	Spent mandrel container, complete
144 5314*	Compression spring
144 5760	Key
144 5763	Sintered-metal bushing
144 5768	Allen screw
144 5769	Magnetic holder screw
144 5770	Spring washer
144 5772	Housing screw, long
144 5773	Housing screw, short
144 5774	Hose, silicone
145 7361	Drive, complete
145 7363	Sintered-metal bushing
145 7364	Housing
146 2906	E-control

\* Wearing parts



You will find detailed nosepiece allocation tables on page 130.  
You will find spare part kits for AccuBird® on page 357.

# BATTERY POWERED BLIND RIVET SETTING TOOLS

**PowerBird® - Tool no longer available**

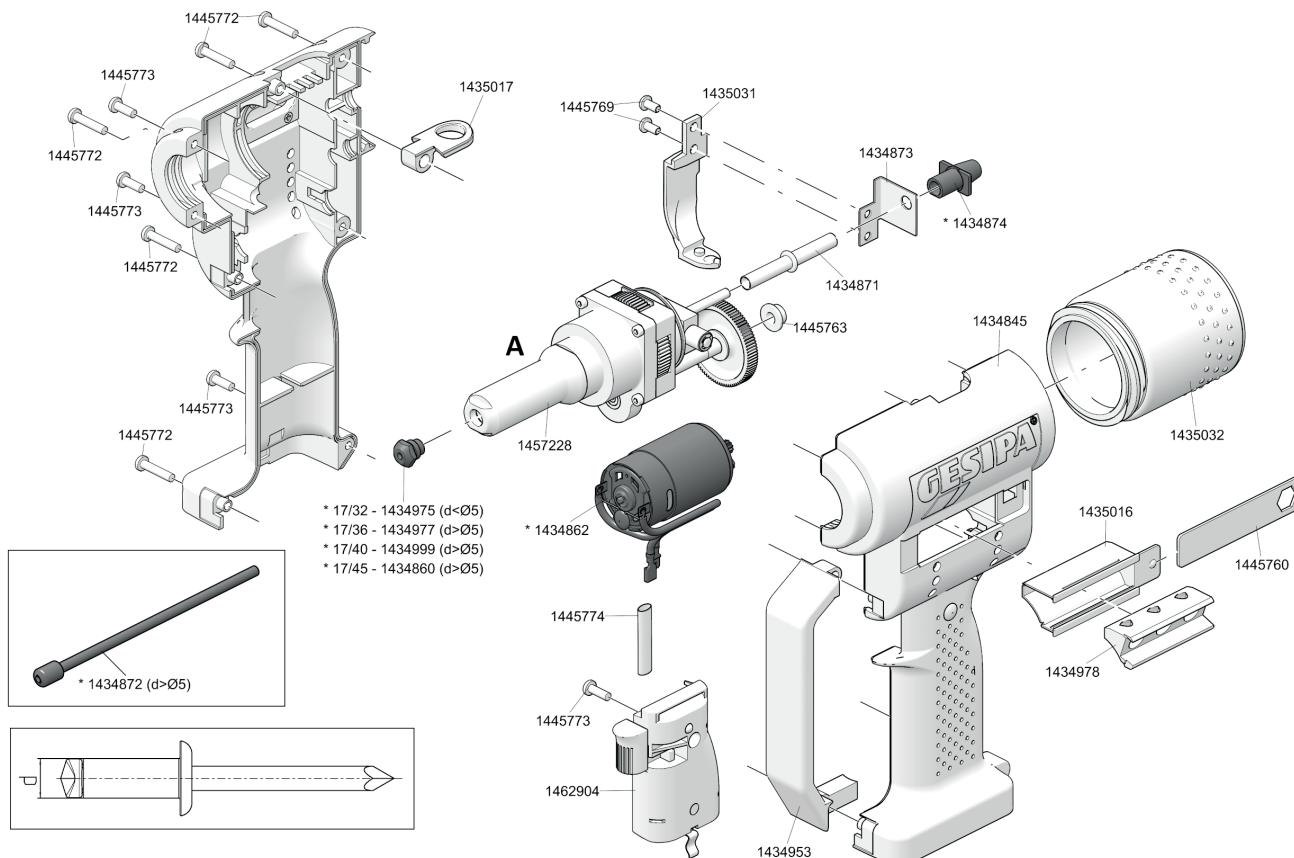
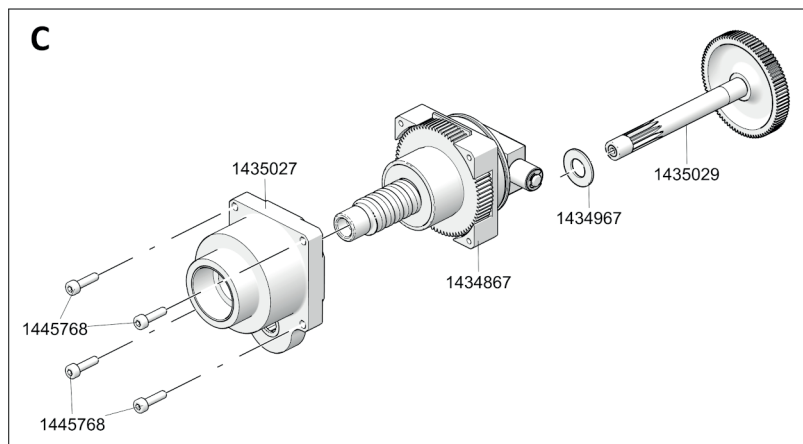
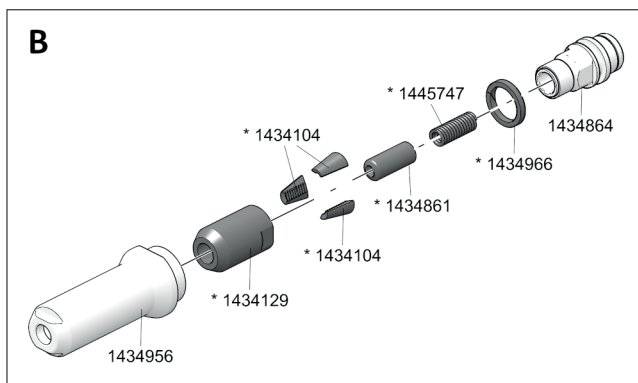
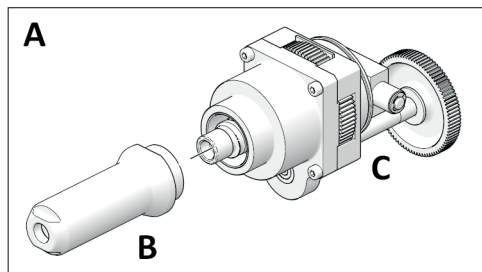

\* Wearing parts

# BATTERY POWERED BLIND RIVET SETTING TOOLS

## **PowerBird® - Tool no longer available**

No.	
143 4104*	Jaws (3-part)
143 4129*	Jaw housing
143 4845	Housing, complete
143 4847	P tube short
143 4860*	Nosepiece 17/45
143 4861*	Jaw Pusher (for BN > Ø 5)
143 4862*	Motor complete
143 4864	Adapter
143 4867	Ball screw drive
143 4871	PB tube
143 4872*	Jaw Pusher
143 4873	Angle
143 4874*	P tube short
143 4953	Hoop guard
143 4956	Steel head sleeve
143 4966*	Wiper
143 4967	Stop disc
143 4975*	Nosepiece 17/32
143 4977*	Nosepiece 17/36
143 4978	Magazine insert
143 4999*	Nosepiece 17/40
143 5016	Nosepiece magazine
143 5017	Hanger

No.	
143 5027	Bearing, complete
143 5029	Pinion shaft
143 5031	Magnetic holder
143 5032	Spent mandrel container, complete
143 5034	Extension
144 5747*	Compression spring
144 5760	Key
144 5763	Sintered-metal bushing
144 5768	Intermediate screw
144 5769	Magnetic holder screw
144 5772	Housing screw long
144 5773	Housing screw short
144 5774	Hose complete
145 7228	Drive, complete
146 2904	E control
146 2907	Safety lubricating grease

\* Wearing parts



You will find detailed nosepiece allocation tables on page 130.  
You will find spare part kits for PowerBird® on page 357.

# BATTERY POWERED BLIND RIVET SETTING TOOLS

**AccuBird® Pro - until April 2021**

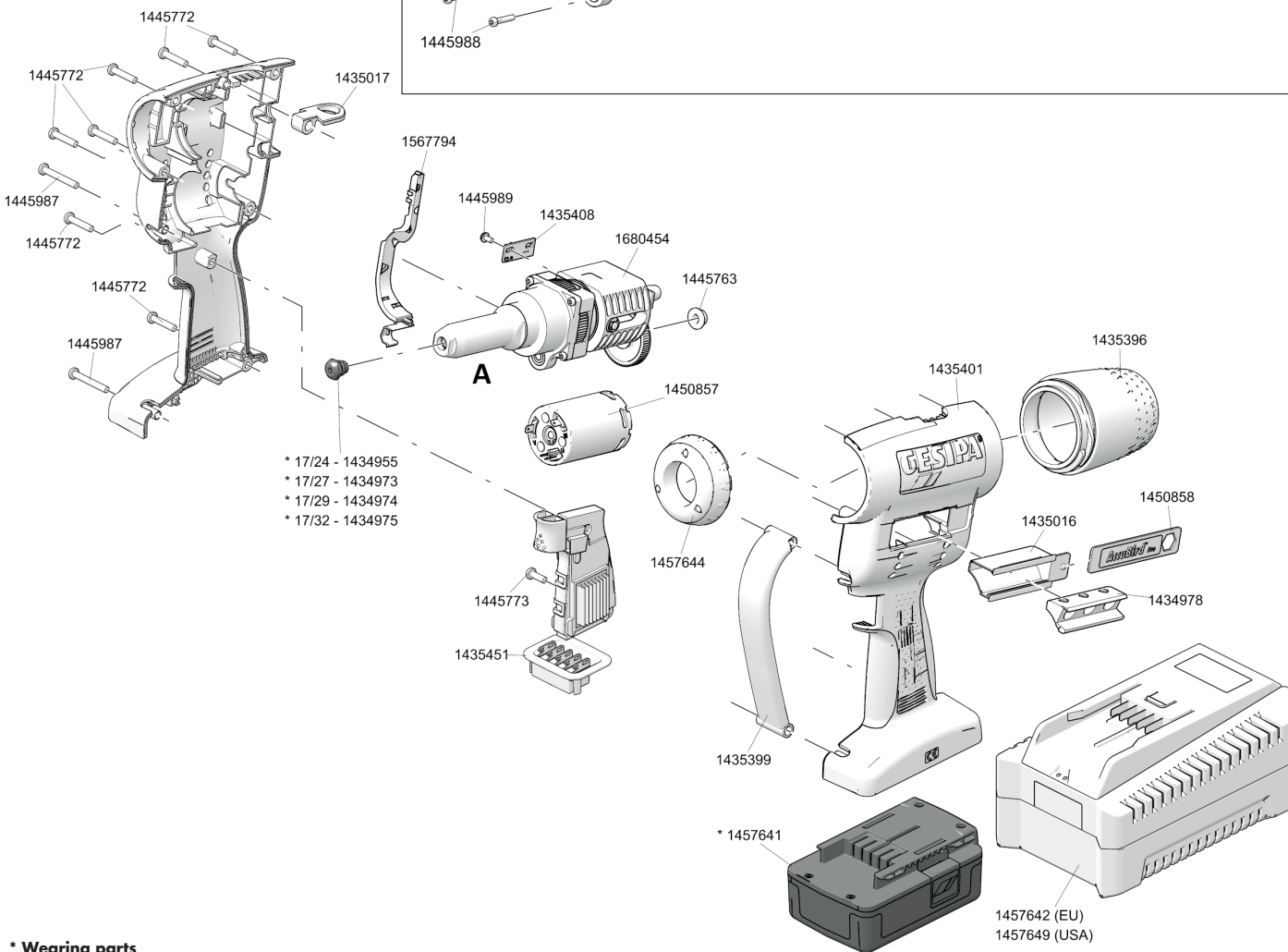
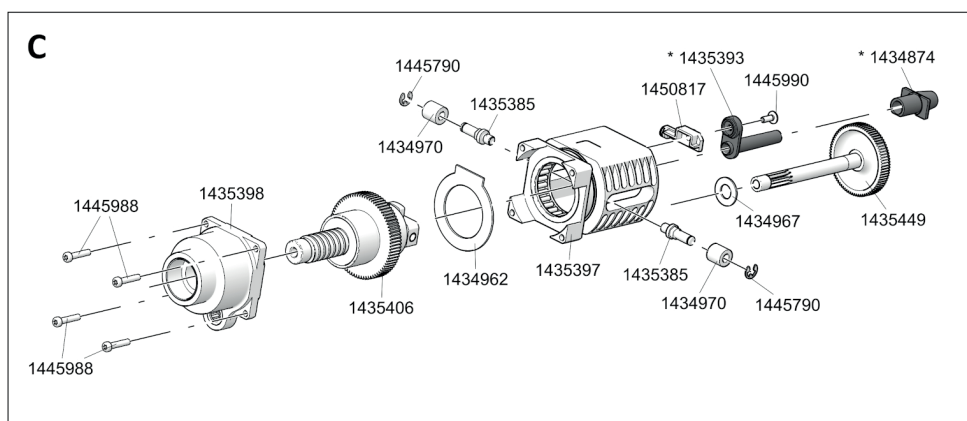
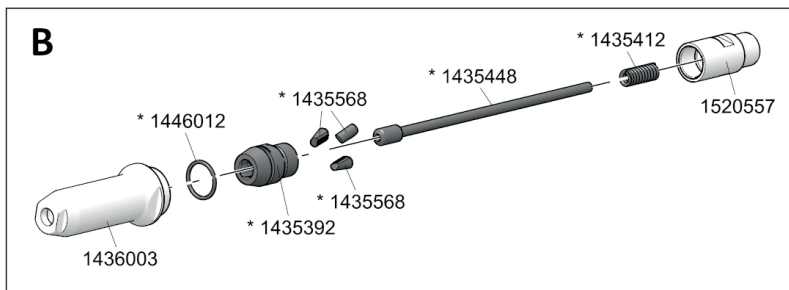
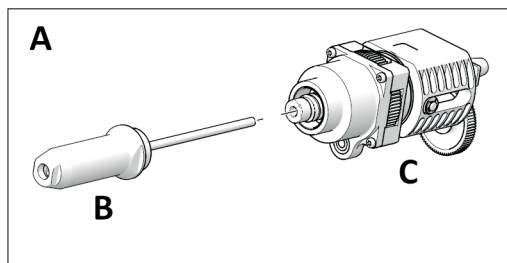

- \* 17/24 - 1434955
- \* 17/27 - 1434973
- \* 17/29 - 1434974
- \* 17/32 - 1434975

\* Wearing parts



# BATTERY POWERED BLIND RIVET SETTING TOOLS

## AccuBird® Pro - until April 2021

No.	
143 4874*	Tube
143 4955*	Nosepiece 17/24
143 4962	Washer
143 4967	Washer
143 4970	Sintered metal roller
143 4973*	Nosepiece 17/27
143 4974*	Nosepiece 17/29
143 4975*	Nosepiece 17/32
143 4978	Magazine insert
143 5016	Nosepiece magazine
143 5017	Hanger
143 5385	Pin
143 5386	Adapter
143 5392*	Jaw housing
143 5393*	Channel tube
143 5396	Spent mandrel container, complete
143 5397	Bearing cage, complete
143 5398	Bearing, complete
143 5399	Tool bar
143 5401	Housing, complete
143 5406	Ball screw drive
143 5408	Plate
143 5412	Spring
143 5413	Connector
143 5414	Threaded bush
143 5415	Spring
143 5448*	Jaw pusher

No.	
143 5449	Pinion shaft
143 5451	Control
143 5568*	Jaws (3-part)
143 6003	Steel head sleeve
144 5763	Sintered-metal bushing
144 5772	Screw, long
144 5773	Screw, short
144 5790	Lock washer
144 5987	Screw
144 5988	Screw
144 5989	Screw
144 5990	Screw
144 6012*	O-ring
145 0817	Magnet
145 0856	Drive unit, complete
145 0857	Motor, complete
145 0858	AccuBird Pro key, complete
145 7641*	Battery
145 7642	Battery charger (EU)
145 7644	Light, complete
145 7649	Battery charger (USA)
156 7794	Cable duct

\* Wearing parts



You will find detailed nosepiece allocation tables on page 130.  
You will find spare part kits for AccuBird® Pro on page 357.

# BATTERY POWERED BLIND RIVET SETTING TOOLS

**AccuBird® Pro with new CAS technology - from May 2021**

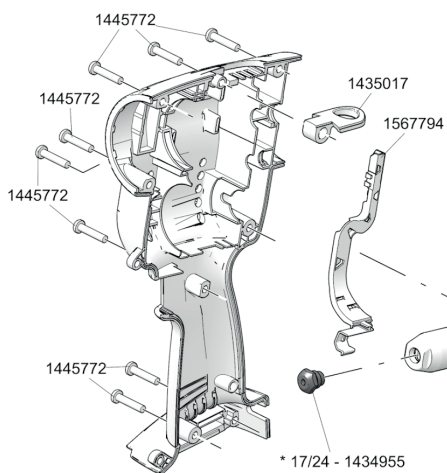
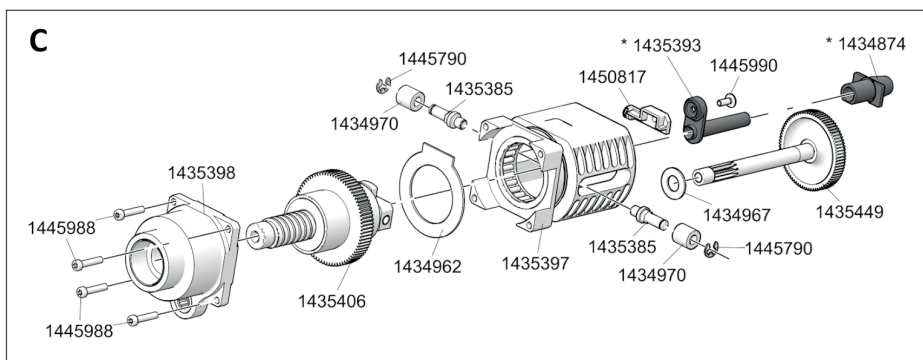
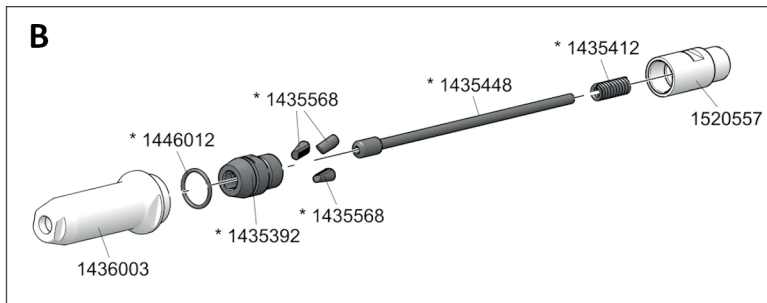
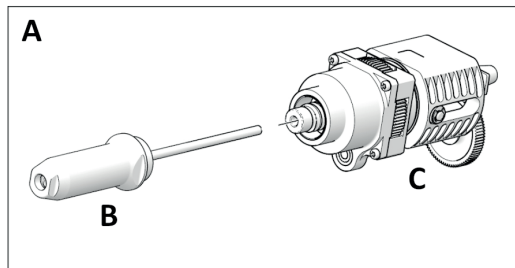

- \* 17/24 - 1434955
- \* 17/27 - 1434973
- \* 17/29 - 1434974
- \* 17/32 - 1434975

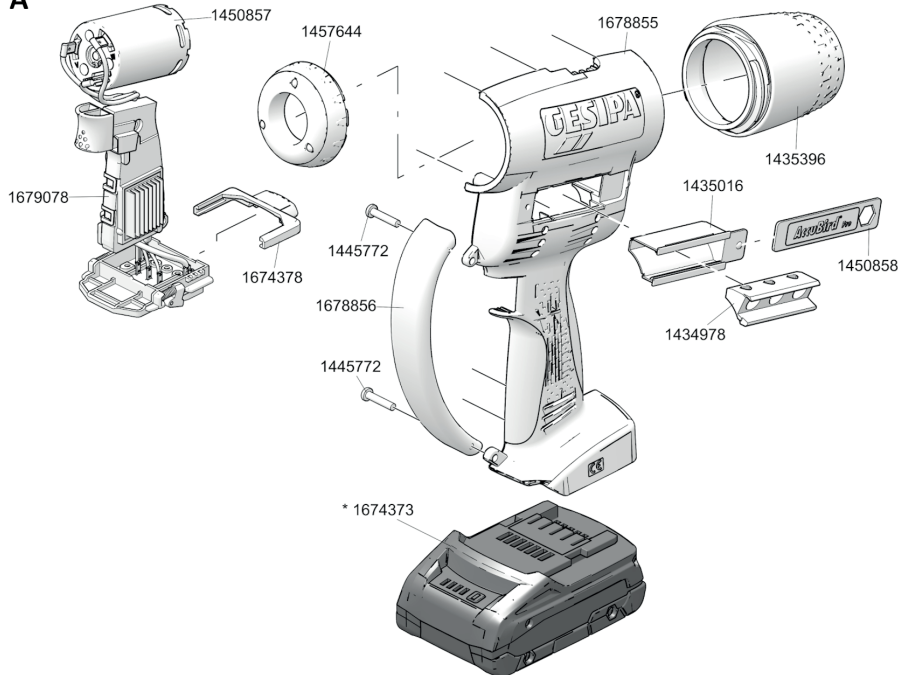
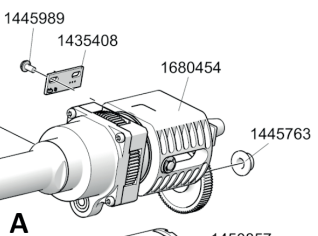

\* Wearing parts

# BATTERY POWERED BLIND RIVET SETTING TOOLS

## AccuBird® Pro with new CAS technology - from May 2021

No.	
143 4874*	Tube
143 4955*	Nosepiece 17/24
143 4962	Washer
143 4967	Washer
143 4970	Sintered metal roller
143 4973*	Nosepiece 17/27
143 4974*	Nosepiece 17/29
143 4975*	Nosepiece 17/32
143 4978	Magazine insert
143 5016	Nosepiece magazine
143 5017	Hanger
143 5385	Pin
143 5392*	Jaw Housing
143 5393*	Channel tube
143 5396	Spent mandrel container, complete
143 5397	Bearing cage, complete
143 5398	Bearing, complete
143 5406	Ball screw drive
143 5408	Plate
143 5412	Spring
143 5448*	Jaw Pusher
143 5449	Pinion shaft
143 5568*	Jaws (3-part)
143 6003	Steel head sleeve
144 5763	Sintered-metal bushing

No.	
144 5772	Screw, long
144 5790	Lock washer
144 5988	Screw
144 5989	Screw
144 5990	Screw
144 6012*	O ring
145 0817	Magnet
145 0857	Motor complete
145 0858	Key AccuBird® Pro complete
145 7644	Light, complete
152 0557	Adapter
156 7794	Cable duct
167 4373*	Battery 2.0 Ah
167 4378	Locking slider
167 8855	Housing
167 8856	Tool bar
167 9078	E control
168 0454	Drive unit

\* Wearing parts



You will find detailed nosepiece allocation tables on page 130.  
You will find spare part kits for AccuBird® Pro on page 357.

# BATTERY POWERED BLIND RIVET SETTING TOOLS

## PowerBird® Pro - tool no longer available

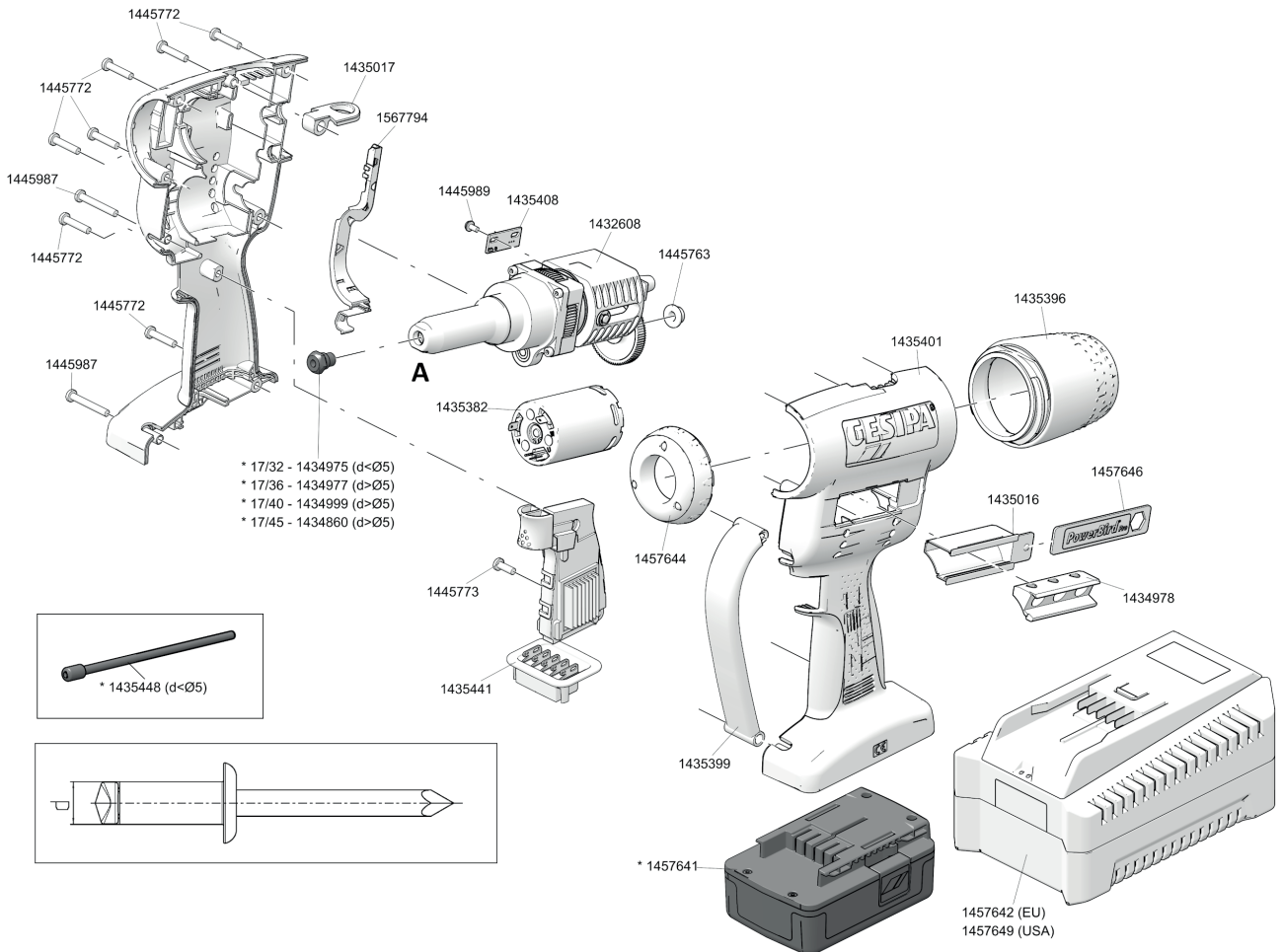
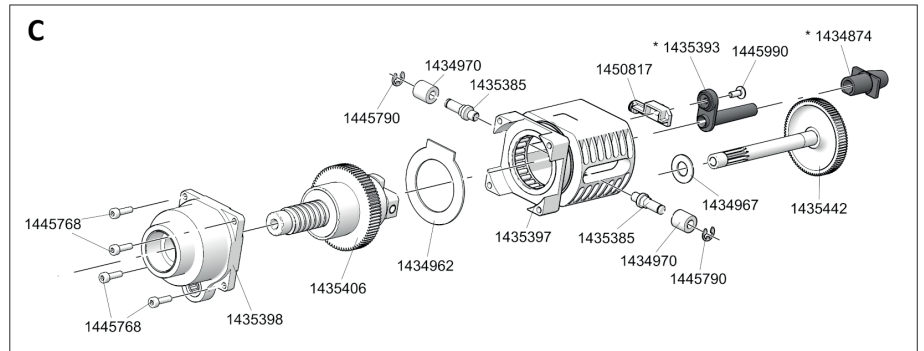
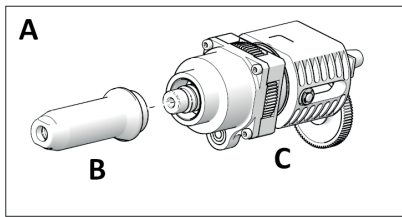
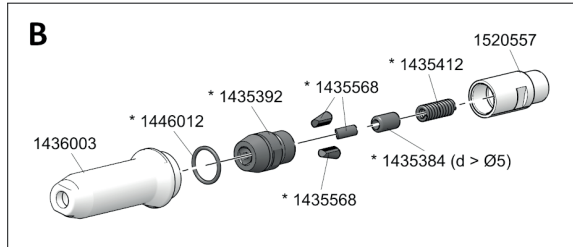

\* Wearing parts

# BATTERY POWERED BLIND RIVET SETTING TOOLS

## **PowerBird® Pro** - tool no longer available

No.	
143 2608	Drive unit
143 4860*	Nosepiece 17/45
143 4874*	Tube short
143 4962	Washer
143 4967	Washer
143 4970	Sintered metal roller
143 4975*	Nosepiece 17/32
143 4977*	Nosepiece 17/36
143 4999*	Nosepiece 17/40
143 4978	Magazine insert
143 5016	Nosepiece magazine
143 5017	Hanger
143 5382	Motor complete
143 5384*	Jaw Pusher (for BN > Ø 5)
143 5385	Pin
143 5392*	Jaw housing
143 5393*	Channel tube
143 5396	Spent mandrel container, complete
143 5397	Bearing cage
143 5398	Bearing, complete
143 5399	Tool bar
143 5401	Housing complete
143 5406	Ball screw drive

No.	
143 5408	Hall pcb
143 5412*	Compression spring
143 5441	E control
143 5442	Pinion shaft
143 5448*	Jaw Pusher (for BN < Ø 5)
143 5568*	Jaws (3 parts)
143 6003	Steel head sleeve
144 5763	Sintered-metal bushing
144 5768	Screw
144 5772	Screw long
144 5773	Screw short
144 5790	Lock washer
144 5987	Screw
144 5989	Screw
144 5990	Screw
144 6012*	O ring
145 0817	Magnetic holder
145 7641*	Battery - while stocks last
145 7642	Charger (EU) - while stocks last
145 7644	Light, complete
145 7646	Key PowerBird® Pro complete
145 7649	Charger (USA) - while stocks last
152 0557	Adapler
156 7794	Cable duct

\* Wearing parts



You will find detailed nosepiece allocation tables on page 130.  
You will find spare part kits for PowerBird® Pro on page 357.

# BATTERY POWERED BLIND RIVET SETTING TOOLS

## PowerBird® Pro Gold Edition - until April 2021

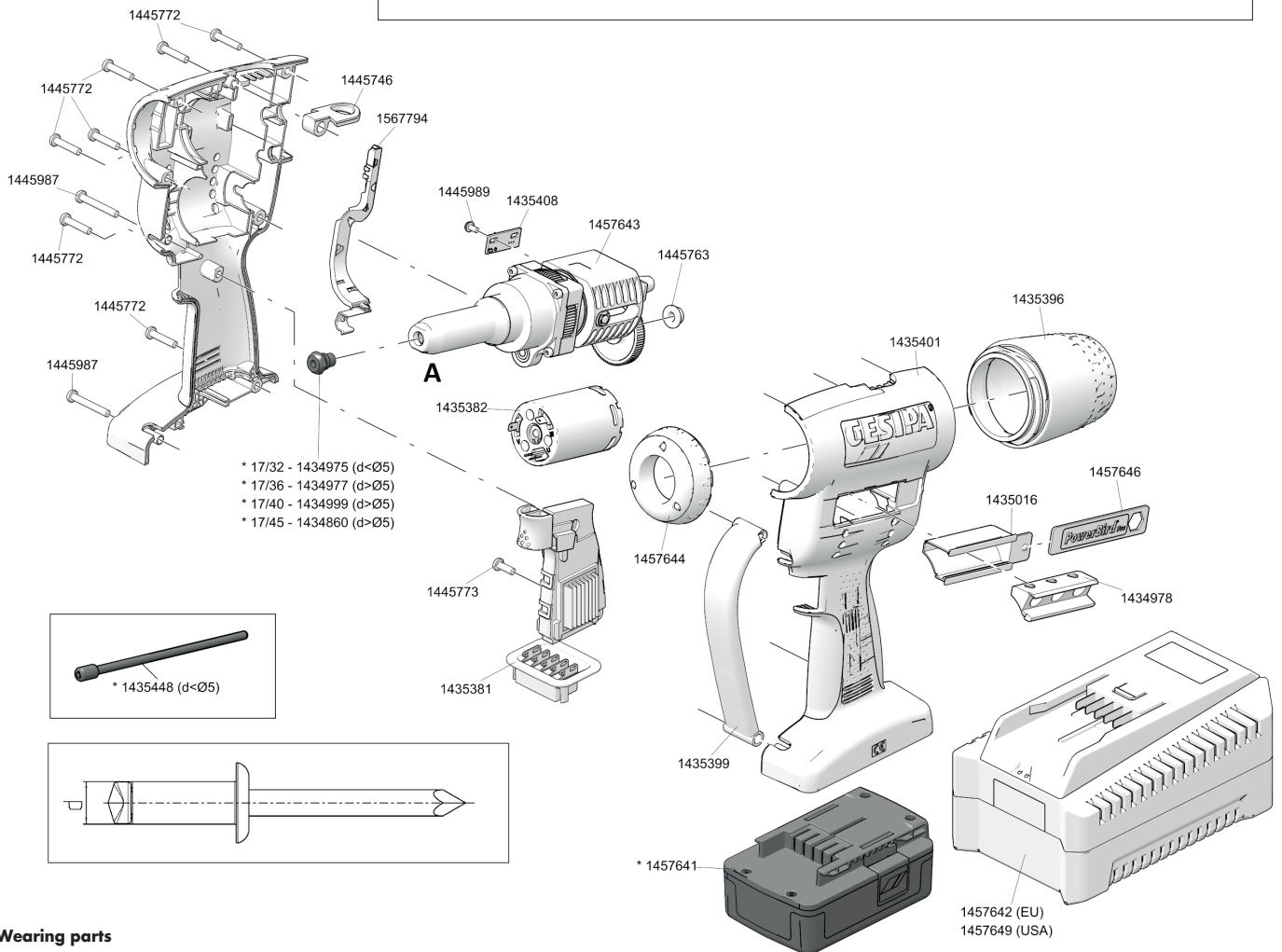
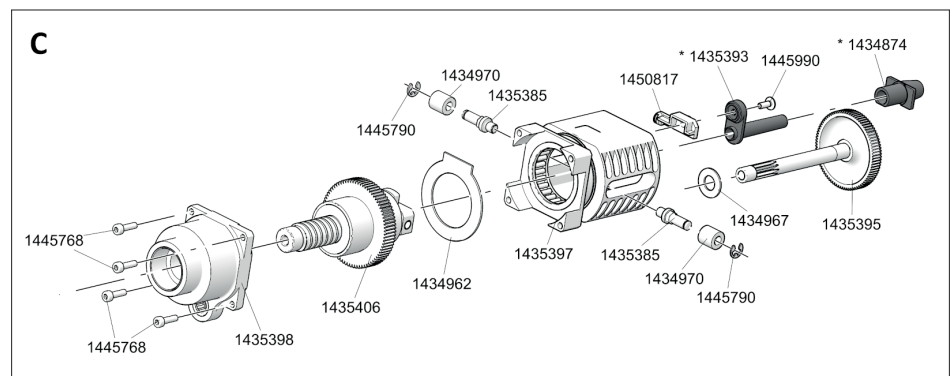
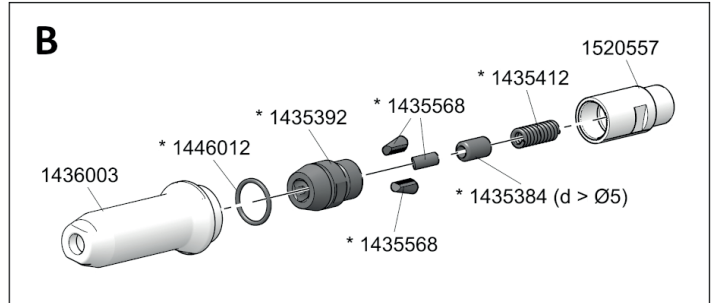
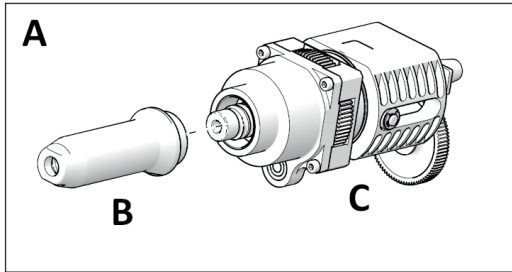

\* Wearing parts

# BATTERY POWERED BLIND RIVET SETTING TOOLS

## **PowerBird® Pro Gold Edition - until April 2021**

No.	
143 4874*	Tube short
143 4962	Washer
143 4967	Washer
143 4970	Sintered metal roller
143 4975*	Nosepiece 17/32
143 4977*	Nosepiece 17/36
143 4999*	Nosepiece 17/40
143 4860*	Nosepiece 17/45
143 4978	Magazine insert
143 5016	Nosepiece magazine
143 5381	E control
143 5382	Motor complete Pro Gold Edition
143 5384*	Jaw Pusher (for BN > Ø 5)
143 5385	Pin
143 5392*	Jaw housing
143 5393*	Channel tube
143 5395	Pinion shaft Pro Gold Edition
143 5396	Spent mandrel container, complete
143 5397	Bearing cage
143 5398	Bearing, complete
143 5399	Tool bar
143 5401	Housing complete
143 5406	Ball screw drive

No.	
143 5408	Hall pcb
143 5412*	Compression spring
143 5448*	Jaw Pusher (for BN < Ø 5)
143 5568*	Jaws (3 parts)
143 6003	Steel head sleeve
144 5746	Hanger Pro Gold Edition
144 5763	Sintered-metal bushing
144 5768	Screw
144 5772	Screw long
144 5773	Screw short
144 5790	Lock washer
144 5987	Screw
144 5989	Screw
144 5990	Screw
144 6012*	O ring
145 0817	Magnetic holder
145 7641*	Battery - while stocks last
145 7642	Charger (EU) - while stocks last
145 7643	Drive unit Pro GE complete
145 7644	Light, complete
145 7646	Key PowerBird® Pro complete
145 7649	Charger (USA) - while stocks last
152 0557	Adapler
156 7794	Cable duct

\* Wearing parts



You will find detailed nosepiece allocation tables on page 130.

# BATTERY POWERED BLIND RIVET SETTING TOOLS

## PowerBird® Pro Gold Edition with new CAS technology - from May 2021

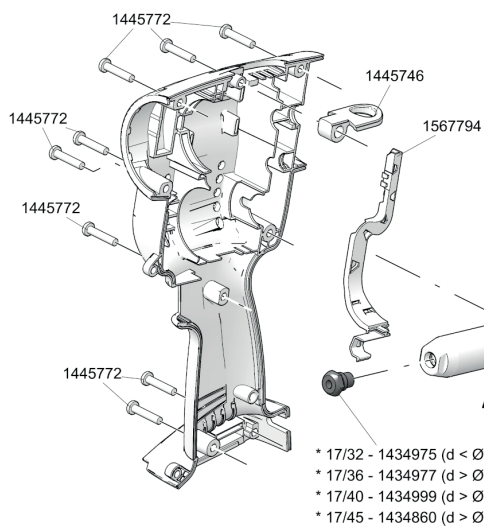
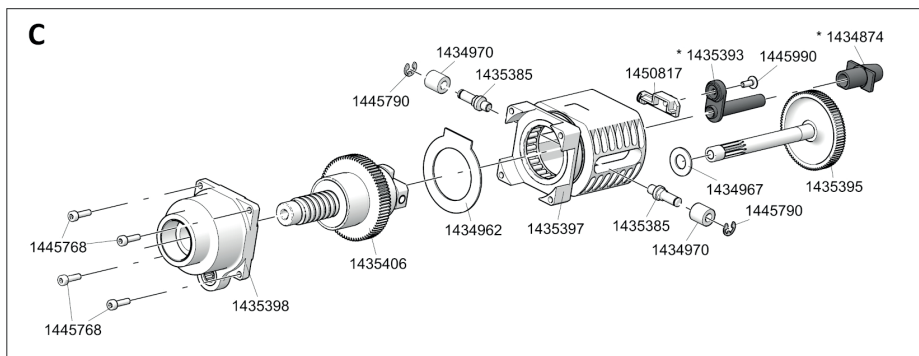
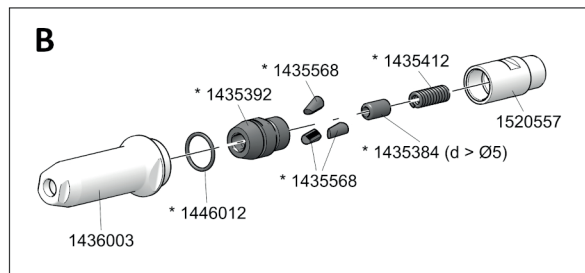
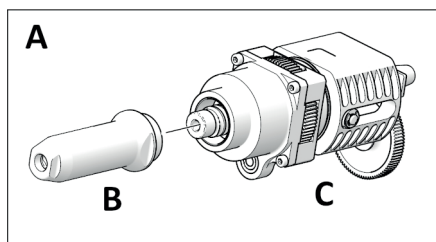

- \* 17/32 - 1434975 (d < Ø5)
- \* 17/36 - 1434977 (d > Ø5)
- \* 17/40 - 1434999 (d > Ø5)
- \* 17/45 - 1434860 (d > Ø5)

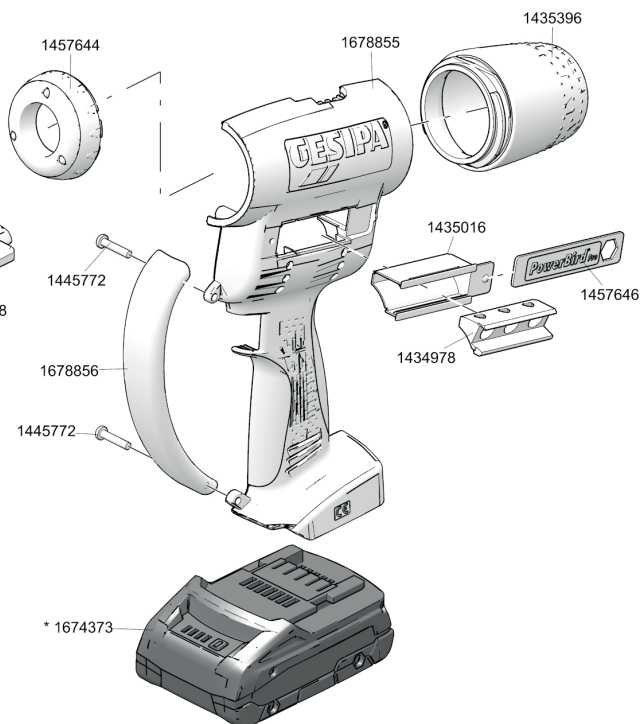
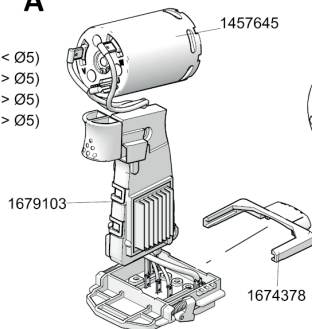
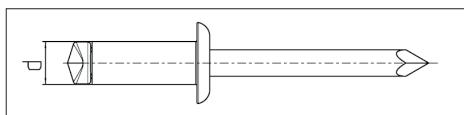
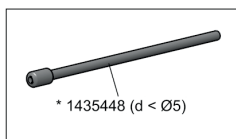

\* Wearing parts



# BATTERY POWERED BLIND RIVET SETTING TOOLS

## **PowerBird® Pro Gold Edition with new CAS technology - from May 2021**

No.	
143 4874*	Tube short
143 4962	Washer
143 4967	Washer
143 4970	Sintered metal roller
143 4975*	Nosepiece 17/32
143 4977*	Nosepiece 17/36
143 4999*	Nosepiece 17/40
143 4860*	Nosepiece 17/45
143 4978	Magazine insert
143 5016	Nosepiece magazine
143 5384*	Jaw Pusher (for BN > Ø 5)
143 5385	Pin
143 5392*	Jaw housing
143 5393*	Channel tube
143 5395	Pinion shaft Pro Gold Edition
143 5396	Spent mandrel container, complete
143 5397	Bearing cage
143 5398	Bearing, complete
143 5406	Ball screw drive
143 5408	Hall pcb
143 5412*	Compression spring
143 5448*	Jaw Pusher (for BN < Ø 5)
143 5568*	Jaws (3 parts)

No.	
143 6003	Steel head sleeve
144 5746	Hanger Pro Gold Edition
144 5763	Sintered-metal bushing
144 5768	Screw
144 5772	Screw long
144 5790	Lock washer
144 5989	Screw
144 5990	Screw
144 6012*	O ring
145 0817	Magnetic holder
145 7643	Drive unit Pro GE complete
145 7644	Light, complete
145 7645	Motor
145 7646	Key PowerBird® Pro complete
152 0557	Adapter
156 7794	Cable duct
167 4373	Battery 2.0 Ah
167 4378	Locking slider
167 8855	Housing
167 8856	Tool bar
167 9103	E control

\* Wearing parts



You will find detailed nosepiece allocation tables on page 130.



# BATTERY POWERED BLIND RIVET SETTING TOOLS

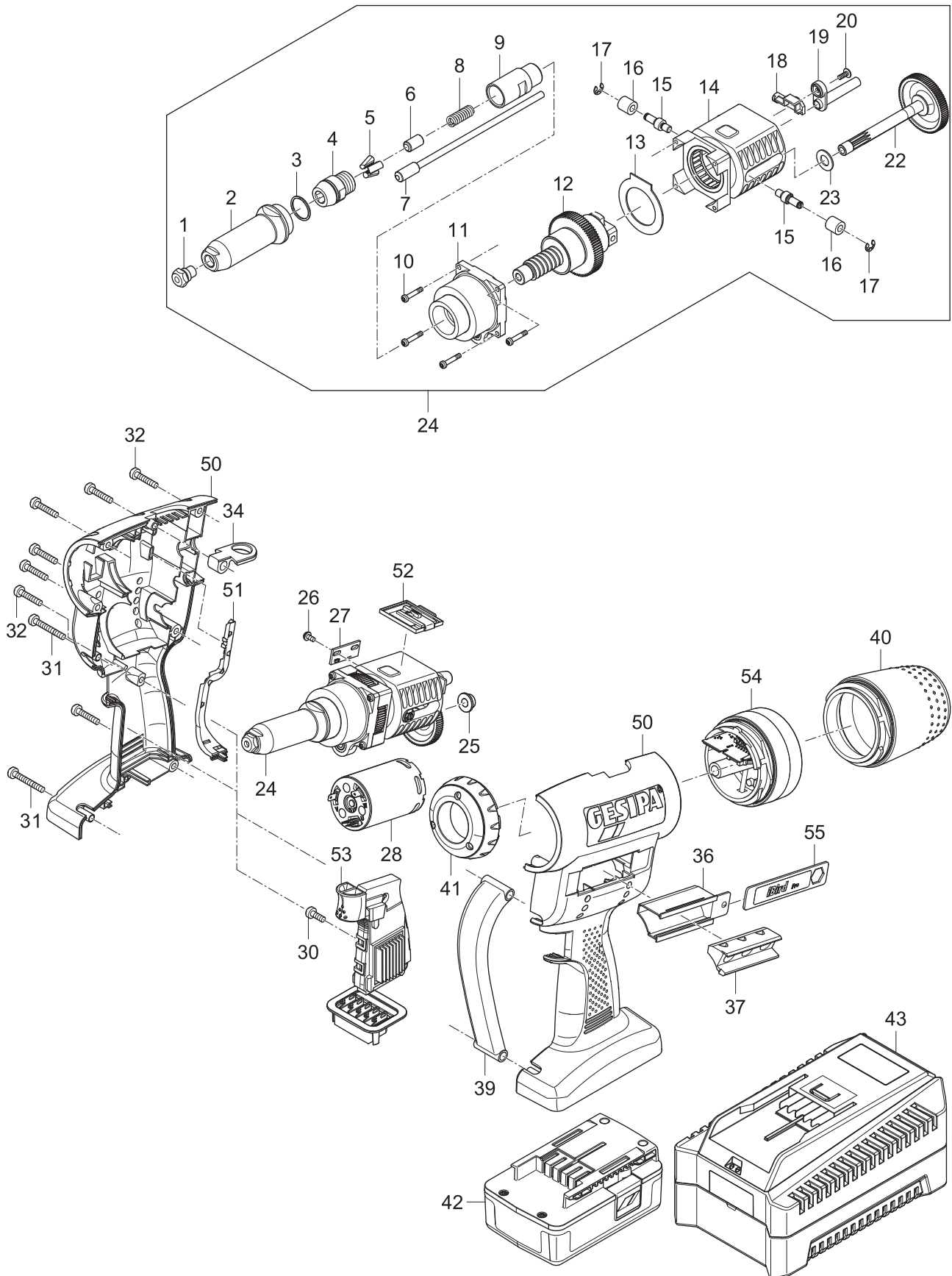

**iBird® Pro - until April 2021**



# BATTERY POWERED BLIND RIVET SETTING TOOLS

## iBird® Pro - until April 2021

	No.	
1 •	143 4975	Nosepiece 17/32
	143 4977	Nosepiece 17/36
	143 4999	Nosepiece 17/40
	143 4860	Nosepiece 17/45
2	143 6003	Steel head sleeve
3 •	144 6012	O-ring
4 •	143 5392	Jaw housing
5 •	143 5568	Jaws (3-part)
6 •	143 5384	Jaw Pusher (> Ø 5)
7 •	143 5448	Jaw Pusher (< Ø 5)
8 •	143 5412	Spring
9	152 0557	Adapter
10	144 5768	Screw
11	143 5398	Bearing, complete
12	143 5406	Ball screw drive
13	143 4962	Washer
14	143 5397	Bearing cage
15	143 5385	Pin
16	143 4970	Sintered metal roller
17	144 5790	Lock washer
18	145 0817	Magnetic holder
19 •	143 5393	Channel tube
20	144 5990	Screw
21 •	143 4874	Tube
22	143 5442	Pinion shaft
	143 5395	Pinion shaft Pro Gold Edition
23	143 4967	Washer

	No.	
24	143 2608	Drive unit Pro complete
	145 7643	Drive unit Pro GE complete
25	144 5763	Sintered-metal bushing
26	144 5989	Screw
27	143 5408	Plate
28	146 3584	Motor complete Pro
	145 7645	Motor complete Pro Gold Edition
30	144 5773	Screw, short
31	144 5987	Screw
32	144 5772	Screw, long
34	143 5416	Hanger Pro
	144 5746	Hanger Pro Gold Edition
36	143 5016	Nosepiece magazine
37	143 4978	Magazine insert
39	143 5399	Tool bar
40	143 5396	Spent mandrel container, complete
41	145 7644	Light, complete
42 •	145 7641	Battery - while stocks last
43	145 7642	Battery charger (EU) - while stocks last
	145 7649	Battery charger (USA) - while stocks last
50	156 7795	Housing, complete
51	156 7794	Cable duct
52	156 7799	NFC module
54*	-	iBird® electronic complete
55	155 6819	Key iBird® Pro complete

- Wearing parts
- \* exchange only by GESIPA®



You will find detailed nosepiece allocation tables on page 130.

# BATTERY POWERED BLIND RIVET SETTING TOOLS

## *iBird® Pro with new CAS technology - from May 2021*

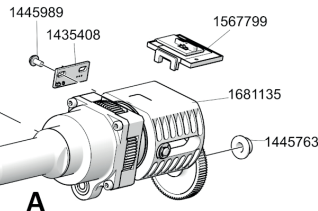
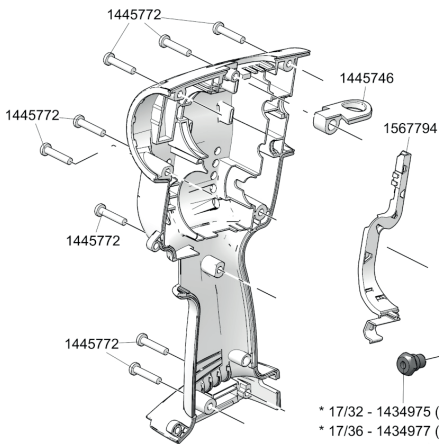
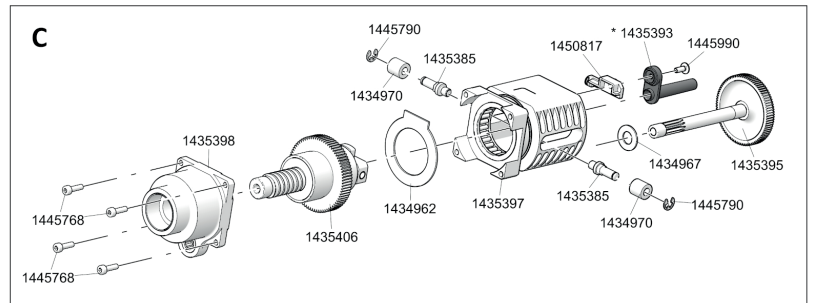
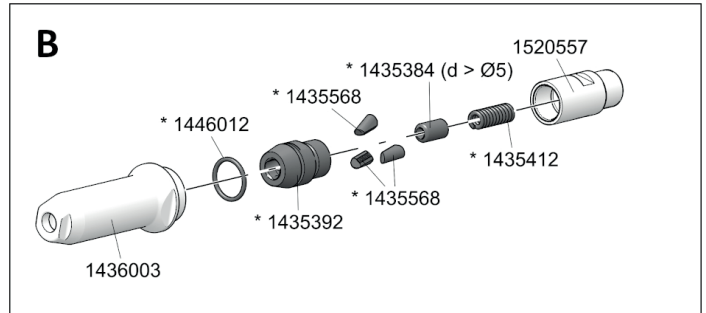
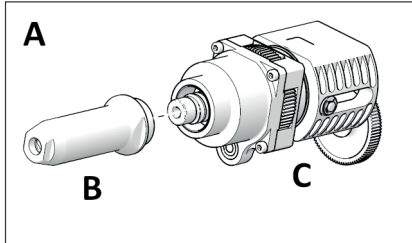

- \* 17/32 - 1434975 (d < Ø5)
- \* 17/36 - 1434977 (d > Ø5)
- \* 17/40 - 1434999 (d > Ø5)
- \* 17/45 - 1434860 (d > Ø5)

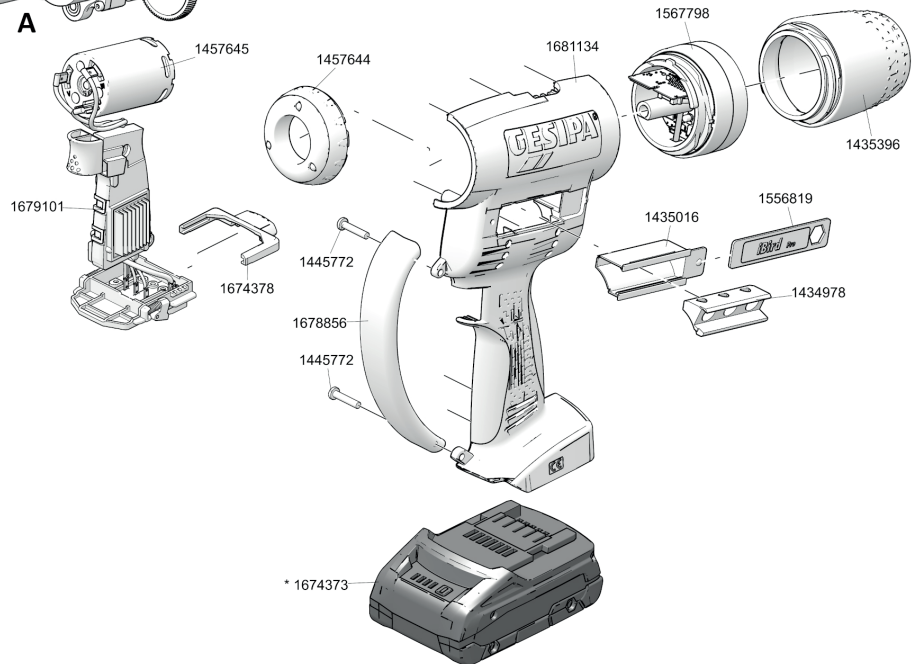
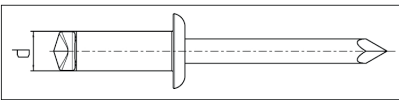
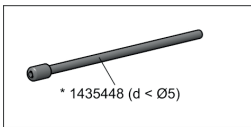

\* Wearing parts

# BATTERY POWERED BLIND RIVET SETTING TOOLS

## **iBird® Pro with new CAS technology - from May 2021**

No.	
143 4860*	Nosepiece 17/45
143 4962	Washer
143 4967	Washer
143 4970	Sintered metal roller
143 4975*	Nosepiece 17/32
143 4977*	Nosepiece 17/36
143 4978	Magazine insert
143 4999*	Nosepiece 17/40
143 5016	Nosepiece magazine
143 5384*	Jaw Pusher (> Ø 5)
143 5385	Pin
143 5392*	Jaw housing
143 5393*	Channel tube
143 5395	Pinion shaft Pro Gold Edition
143 5396	Spent mandrel container, complete
143 5397	Bearing cage
143 5398	Bearing, complete
143 5406	Ball screw drive
143 5408	Plate
143 5412*	Spring
143 5448*	Jaw Pusher (< Ø 5)
143 5568*	Jaws (3-part)
143 6003	Steel head sleeve
144 5746	Hanger Pro Gold Edition
144 5763	Sintered-metal bushing
144 5768	Screw
144 5772	Screw long
144 5790	Lock washer

No.	
144 5989	Screw
144 5990	Screw
144 6012*	O ring
145 0817	Magnetic holder
145 7644	Light, complete
145 7645	Motor complete Pro Gold Edition
152 0557	Adapter
155 6819	Key iBird® Pro complete
156 7794	Cable duct
156 7798**	iBird module
156 7799	NFC module
167 4373*	Battery 2.0 Ah
167 4378	Locking slider
167 8856	Tool bar
167 9101	E control
168 1134	Housing
168 1135	Drive unit

**\* Wearing parts**

\*\* exchange only by GESIPA®



You will find detailed nosepiece allocation tables on page 130.

# BATTERY POWERED BLIND RIVET SETTING TOOLS

## Bird Pro series with spring-loaded trigger system - until April 2021

No.	Image	Description	
1 •		Nosepiece 17/24 AV	
143 5592		AccuBird® Pro	
143 5593			Nosepiece 17/27 AV
143 5594			Nosepiece 17/29 AV
143 5595		PowerBird® Pro, PowerBird® Pro GE	Nosepiece 17/32 AV
143 5596			Nosepiece 17/36 AV
143 5597			Nosepiece 17/40 AV
143 5598	Nosepiece 17/45 AV		
2		Steel head sleeve	
3		O-ring	
4	AccuBird® Pro	Support sleeve	
	PowerBird® Pro, PowerBird® Pro GE	Support sleeve	
5		Snap ring	
6		Support sleeve	
7	AccuBird® Pro	Nosepiece	
	PowerBird® Pro, PowerBird® Pro GE	Nosepiece	
8 •		O-ring	
9 •		Jaw housing	
10 •		Jaws (3-part)	
11 •	PowerBird® Pro, PowerBird® Pro GE	Jaw Pusher	
	AccuBird® Pro	Jaw Pusher	
12		Spring	
13		Adapter AV	
14 •		Spring	
15		Screw	
16		Pressing unit	
17		Union nut	
18		O-ring	
19		Ball screw drive	
20		Washer	
21		Bearing cage	
22		Pin	
23		Sintered metal roller	
24		Lock washer	
25		Magnetic holder	
26		Channel tube	
27		Screw	
28		Tube	
29		Washer	

No.	Image	Description
30	PowerBird® Pro GE	Pinion shaf
	AccuBird® Pro, Power-Bird® Pro	Pinion shaf
31	PowerBird® Pro GE	Drive unit PowerBird® Pro GE AV max. Ø 4,5 mm
	PowerBird® Pro	Drive unit PowerBird® Pro GE AV max. Ø 4,5 mm
	AccuBird® Pro	Drive unit AccuBird® Pro AV max. Ø 3,2 mm
32		Sintered-metal bushing
33		Plate
34		Screw
35	PowerBird® Pro GE	Motor complete
	PowerBird® Pro	Motor complete
	AccuBird® Pro	Motor complete
36	PowerBird® Pro GE	Control
	PowerBird® Pro	Control
	AccuBird® Pro	Control
37		Screw short
38		Screw
39		Screw long
40		Housing, complete
41	PowerBird® Pro GE	Hanger
	PowerBird® Pro	Hanger
	AccuBird®	Hanger
42		Cable duct
43		Nosepiece magazine
44		Magazine insert
45	PowerBird® Pro	Key complete
	AccuBird® Pro	Key complete
46		Tool bar
47		Spent mandrel container, complete
48 •		Battery
49		Battery charger (EU)
		Battery charger (EU)

### • Wearing parts

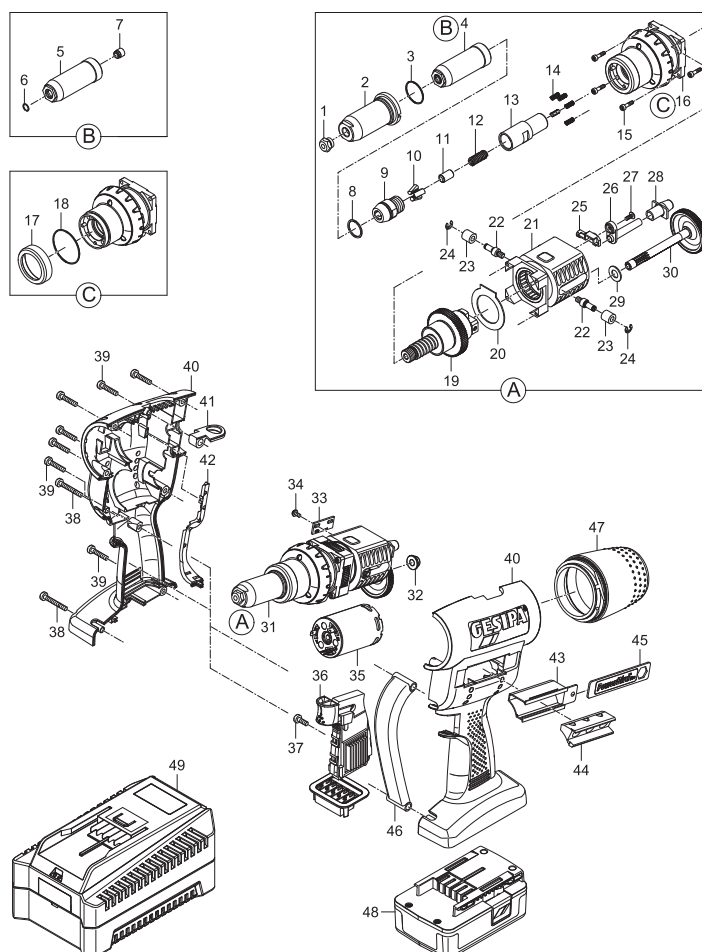

# BATTERY POWERED BLIND RIVET SETTING TOOLS

## Bird series with spring-loaded trigger system

No.	Icon	Icon	
1 •	143 4955	AccuBird®  PowerBird®, PowerBird® GE	
	143 4973		
	143 4974		
	143 4975		
	143 4977		
	143 4999		
	143 4860		
2	143 4889	Steel head sleeve	
3 •	143 4129	Jaw housing	
4 •	143 4958	AccuBird®	Jaws (3-part)
	143 4104	PowerBird®, PowerBird® GE	Jaws (3-part)
5 •	143 4959	AccuBird®	Jaw pusher
	143 4861	PowerBird®, PowerBird® GE	Jaw pusher
6	143 4957	AccuBird®	Adapter
	143 4864	PowerBird®, PowerBird® GE	Adapter
7 •	144 5314	AccuBird®	Compression spring
	144 5753	PowerBird®, PowerBird® GE	Compression spring
8	143 4966	Wiper	
9	143 4888	Union nut	
10	143 4886	Adapter	
11	144 5269	Spring	

No.	Icon	Icon	
12	143 5529	O-ring	
13	143 4885	Bushing	
14	143 4890	Cover	
15	144 5755	Stud bolt	
16	144 5751	Spring	
17	143 4887	Trigger	
18	144 5328	Cylinder pin	
19	144 5768	Allen screw	
20	143 5027	Bearing, complete	
21	145 7363	AccuBird®	Ball screw drive
	143 4867	PowerBird®, PowerBird® GE	Ball screw drive
22	143 4967	Stop disc	
23	143 5028	Pinion shaft	
24	143 4871	PowerBird®, PowerBird® GE	PB tube
25	143 4873		Angle
26	143 4874		PB tube short
27	144 5763		Sintered-metal bushing
28	143 5031	Magnetic holder	
29	144 5769	Magnetic holder	
30	143 4892	E control	
31	144 5774	Hose complete	
32 •	143 5030	AccuBird®	Motor, complete
	143 4862	PowerBird®, PowerBird® GE	Motor, complete
33	144 5773	Housing screw short	
34	144 5772	Housing screw long	
35	143 4917	AccuBird®	Housing, complete
	143 4891	PowerBird®, PowerBird® GE	Housing, complete
36	143 5017	AccuBird®	Hanger
	143 5417	PowerBird®	Hanger
	144 5746	PowerBird® GE	Hanger
37	143 5016	Nosepiece magazine	
38	143 4978	Magazine insert	
39	144 5760	Key	
40	144 5752	Button	
41	143 4953	Hoop guard	
42	143 5032	AccuBird®, PowerBird®	Spent mandrel container, complete
	143 4851	PowerBird® GE	Spent mandrel container, complete
43	143 5034	Extension	
44	143 4952	AccuBird®	Plastic tube
	146 2907		Safety lubrication grease 40 g tube
	143 4815		Pipe wrench

• Wearing parts

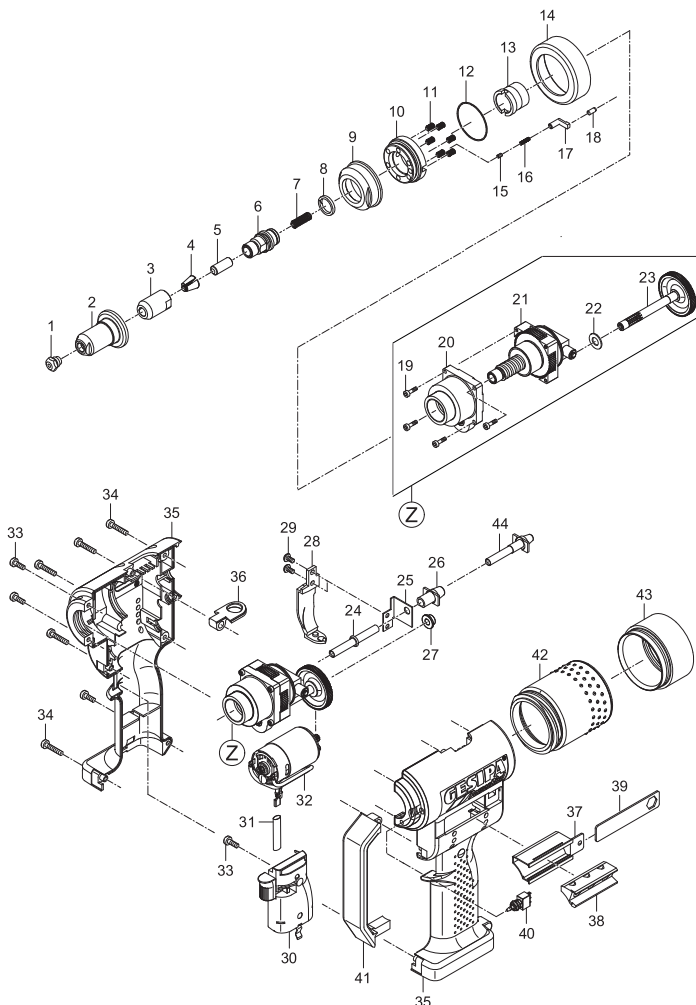

# BATTERY POWERED BLIND RIVET SETTING TOOLS

## AccuBird® and PowerBird® angle head 90°

No.	
143 4104*	Jaws (3-part)
143 4977*	Nosepiece 17/36
143 4992*	Jaw pusher
143 5908	Bolt
143 5911	Axis bolt
143 5914	Spacer
143 5918*	Jaw housing
143 5926	Steel head sleeve
143 5935	Coupler
143 5936	Angle

No.	
143 5938	Guiding cable piece
143 5940	Lock activator
143 5959	Adapter
143 5963	Protecting cap
144 5545	Snap ring
144 5747*	Compression spring
144 6013	Oil screw
145 0623	Fork head
145 0624	Housing unit

\* Wearing parts

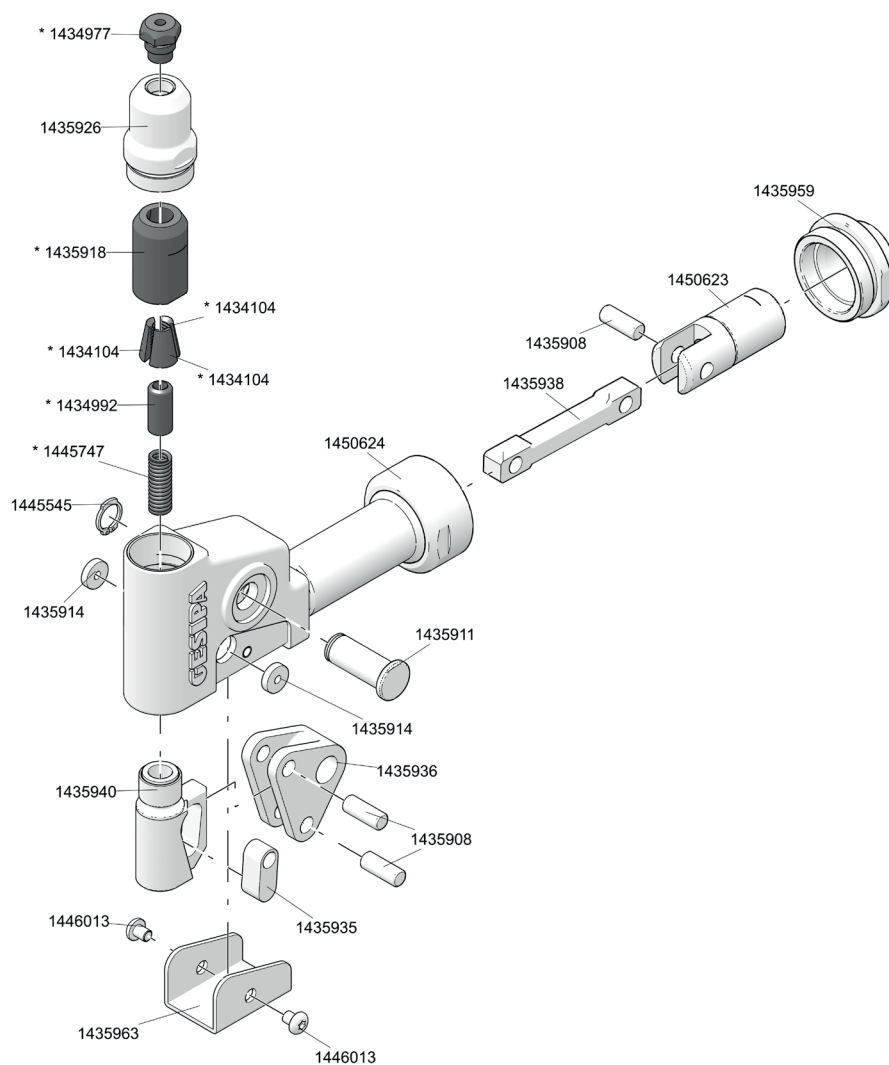



\* Wearing parts



## One-piece extension units

### Extension unit for AccuBird®

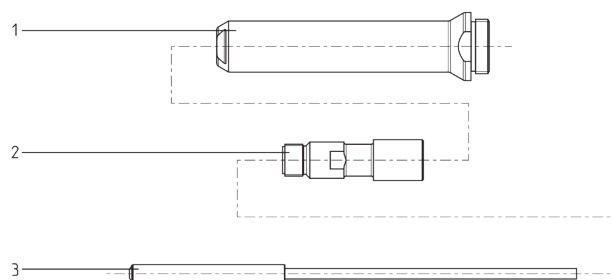

50 mm: Article no. 145 7273  
 100 mm: Article no. 145 7274  
 150 mm: Article no. 145 0622

		No.	
50 mm	1	143 4836	Steel head sleeve
	2	143 4837	Extension piece
	3	143 4903	Jaw pusher
100 mm	1	143 4839	Steel head sleeve
	2	143 4840	Extension piece
	3	143 4996	Jaw pusher
150 mm	1	143 4841	Steel head sleeve
	2	143 4842	Extension piece
	3	143 4905	Jaw pusher



### Extension unit for PowerBird® - while stocks last

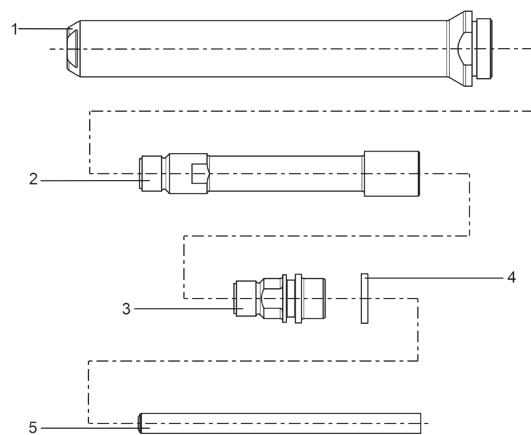

50 mm: Article no. 145 7214  
 100 mm: Article no. 145 7215  
 150 mm: Article no. 146 4038

		No.	
50 mm	1	143 4836	Steel head sleeve
	2	143 4837	Extension piece
	3	143 4957	Adapter
	4	143 4966	Wiper
	5	143 4838	Jaw pusher
100 mm	1	143 4839	Steel head sleeve
	2	143 4840	Extension piece
	3	143 4957	Adapter
	4	143 4966	Wiper
	5	143 4870	Jaw pusher
150 mm	1	143 4841	Steel head sleeve
	2	143 4842	Extension piece
	3	143 4957	Adapter
	4	143 4966	Wiper
	5	143 4843	Jaw pusher



### Extension unit for PowerBird® spring loaded trigger system - while stocks last

50 mm: Article no. 145 7222  
 100 mm: Article no. 145 7224

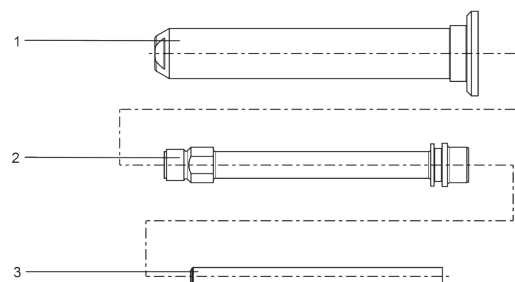

		No.	
50 mm	1	143 4832	Steel head sleeve
	2	143 4833	Extension piece
	3	143 4834	Jaw pusher
100 mm	1	143 4849	Steel head sleeve
	2	143 4850	Extension piece
	3	143 4870	Jaw pusher



## One-piece extension units

### Extension unit for AccuBird® Pro

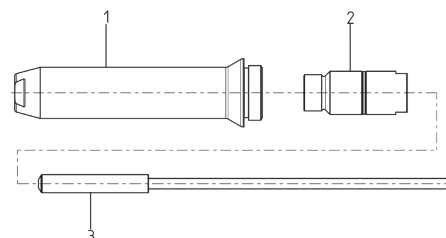

<b>+35 mm:</b>	<b>Article no.</b>	<b>145 0860</b>
<b>+85 mm:</b>	<b>Article no.</b>	<b>145 0861</b>
<b>+135 mm:</b>	<b>Article no.</b>	<b>145 0862</b>

		No.	
<b>+35 mm</b>	1	143 5473	Extension sleeve
	2	145 0832	Extension piece
	3	143 5427	Jaw pusher
<b>+85 mm</b>	1	143 5476	Extension sleeve
	2	145 0833	Extension piece
	3	143 5428	Jaw pusher
<b>+135 mm</b>	1	143 5487	Extension sleeve
	2	145 0834	Extension piece
	3	143 5429	Jaw pusher



### Extension unit for PowerBird® Pro Gold Edition

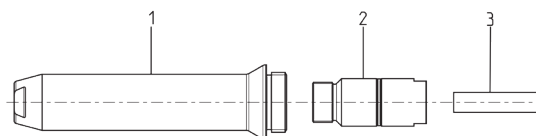

<b>+35 mm:</b>	<b>Article no.</b>	<b>145 7650</b>
<b>+85 mm:</b>	<b>Article no.</b>	<b>145 7651</b>
<b>+135 mm:</b>	<b>Article no.</b>	<b>145 0823</b>

		No.	
<b>+35 mm</b>	1	143 5473	Extension sleeve
	2	145 0832	Jaw pusher
	3	143 5881	Extension piece
<b>+85 mm</b>	1	143 5476	Extension sleeve
	2	145 0833	Jaw pusher
	3	143 5882	Extension piece
<b>+135 mm</b>	1	143 5487	Extension sleeve
	2	145 0834	Jaw pusher
	3	143 5879	Extension piece





### Extension unit for PowerBird® Pro Gold Edition spring loaded trigger system

<b>+50 mm:</b>	<b>Article no.</b>	<b>145 0821</b>
<b>+100 mm:</b>	<b>Article no.</b>	<b>145 0822</b>

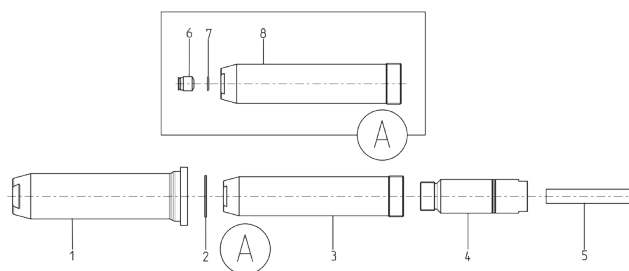
		No.	
<b>+50 mm</b>	1	143 5433	Steel head sleeve AV
	2	143 4253	O-ring
	3	145 0830	Support sleeve AV complete
	4	145 0835	Extension piece
	5	143 5902	Intermediate bush 1
	6	143 5601	Nosepiece
	7	144 6010	Snap ring
	8	143 5431	Support sleeve AV
<b>+100 mm</b>	1	143 5434	Steel head sleeve AV
	2	143 4253	O-ring
	3	145 0831	Support sleeve AV complete
	4	145 0836	Extension piece
	5	143 5903	Intermediate bush 1
	6	143 5601	Nosepiece
	7	144 6010	Snap ring
	8	143 5432	Support sleeve AV



 Extension units also suitable for the new CAS tools.



## Multi-piece extension units

arbitrary extension of the tool head in 100 mm steps

### AccuBird® extension unit 100 mm - while stocks last

Article no. 145 7318

	No.	
1	143 4995	Extension sleeve
2	143 4165	Extension piece
3	143 4996	Jaw pusher

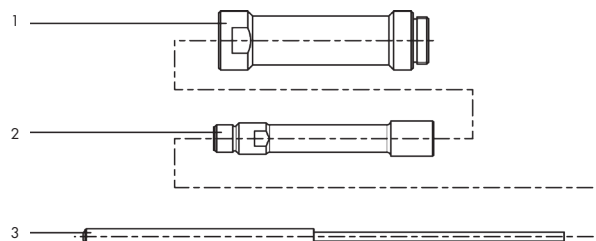

### PowerBird® extension unit 100 mm - while stocks last

Article no. 145 7229

	No.	
1	143 4995	Extension sleeve
2	143 4165	Extension piece
3	143 4870	Jaw pusher

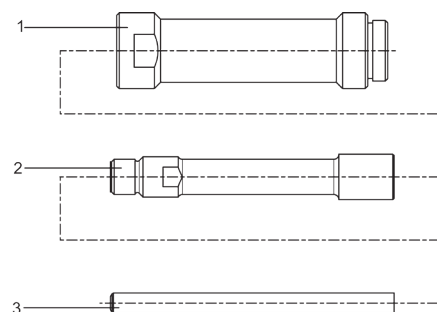

### AccuBird® Pro extension unit 100 mm

Article no. 145 0859

	No.	
1	143 4995	Extension sleeve
2	162 3993	Adapter
3	143 5430	Jaw pusher

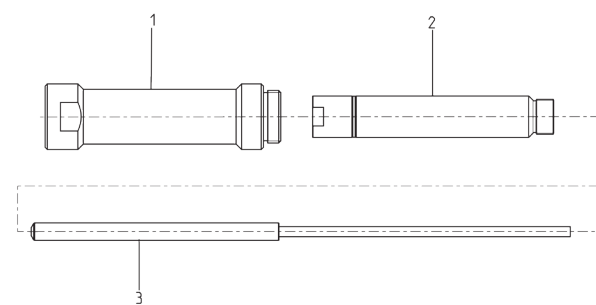



### PowerBird® Pro Gold Edition extension unit 100 mm

Article no. 145 0820

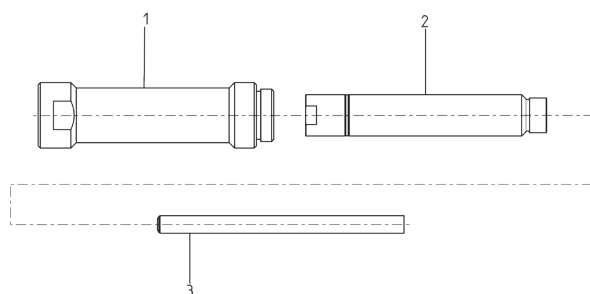
	No.	
1	143 4995	Extension sleeve
2	162 3993	Adapter
3	143 4870	Jaw pusher



 Extension units also suitable for the new CAS tools.



# HYDRO-PNEUMATIC BLIND RIVET SETTING TOOLS

## TAURUS® 1-4

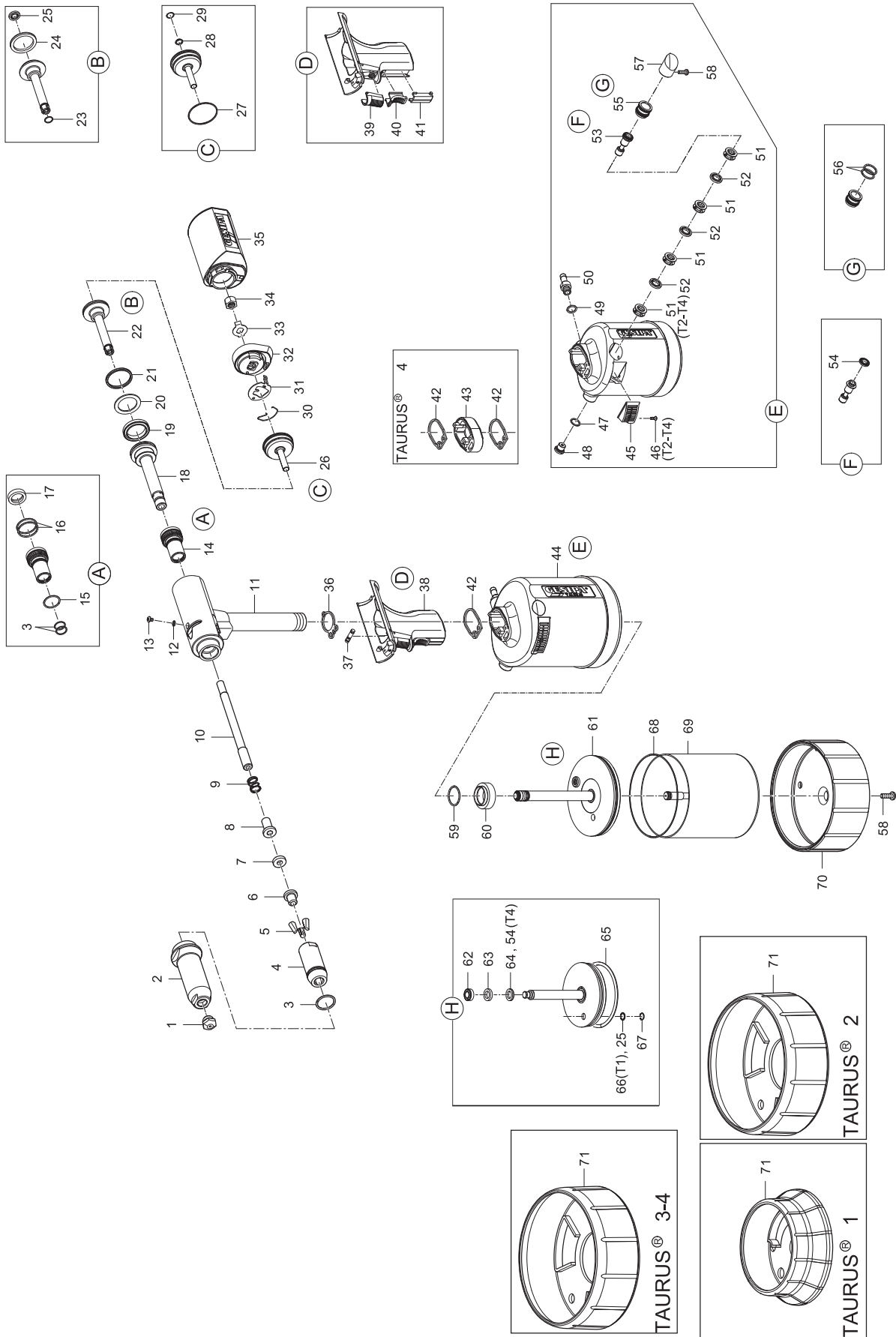

# HYDRO-PNEUMATIC BLIND RIVET SETTING TOOLS

## TAURUS® 1-4

		No.	
1 •	T1	143 4976	Nosepiece 17/18
		143 4994	Nosepiece 17/20
		143 5018	Nosepiece 17/22
	T2	143 4955	Nosepiece 17/24
		143 4973	Nosepiece 17/27
		143 4974	Nosepiece 17/29
		143 4975	Nosepiece 17/32
	T3, T4	143 4977	Nosepiece 17/36
		143 4999	Nosepiece 17/40
		143 4860	Nosepiece 17/45
2		143 6003	Steel head sleeve
3 •		144 6012	O-ring
4 •		143 6002	Jaw housing 4
5 •		143 5568	Jaws (3-part)
6 •	T1	143 5507	Jaw pusher 1
	T2	143 5768	Jaw pusher 2
	T3, T4	143 6000	Jaw pusher 4
7		143 5999	Damping ring 4
8	T1	143 5509	Centre part 1
	T2	143 5769	Centre part 2
	T3, T4	143 6001	Centre part 3
9 •		146 3064	Spring
10	T1	143 5558	Nozzle tube 1
	T2	143 5764	Nozzle tube 2, longe
	T3, T4	143 5886	Nozzle tube 3, longe
11	T1	145 7745	Tool head 1, assembled
	T2, T3	145 7856	Tool head 2, assembled
	T4	145 7992	Tool head 4, assembled
12		144 6013	Oil screw plug
13		143 5612	Sealing ring M4
14		143 5681	Seal holder, complete
15 •		143 5629	O-ring
16 •		143 4227	O-ring
17 •		143 5630	Rod seal
18		143 5631	Draw bar
19 •		143 5632	Piston seal
20 •		143 5488	Supporting ring
21 •		143 5485	Piston seal
22		145 7746	Resetting piston, complete
23		143 5671	O-ring
24 •		143 5633	Piston seal
25		143 5635	Rod seal
26	T1	165 1223	End cap
	T2, T3, T4	145 7840	End cap
27		143 5524	O-ring
28		143 5519	O-ring
29		144 6167	Snap ring
30		144 6028	Retaining spring
31		143 5664	Retainer
32		143 5663	Adapter
33		143 5842	Lock washer
34	T1	143 5849	Connecting piece nut 1
	T2, T3, T4	143 5766	Connecting piece nut 2/3
35	T1, T2	143 5677	Spent mandrel container, complete
	T3, T4	143 5964	Spent mandrel container, complete
36 •		143 5472	Flat gasket 1
37		145 7747	Distributing valve, complete
38		145 7748	Grip, complete
39		144 6025	Activation button
40		143 5642	Slider
41		143 5686	Orifice
42 •		143 5480	Flat gasket 2
43	T4	143 5998	Grip extension

		No.	
44	T1	145 7749	Air cylinder 1, complete
	T2	145 7859	Air cylinder 2, complete
	T3	145 7950	Air cylinder 3, complete
	T4	145 7993	Air cylinder 4, complete
45	T1	151 5051	Silencer complete
	T2	145 7862	Silencer complete
	T3, T4	145 7956	Silencer complete
46		144 6089	Screw
47		143 5484	O-ring
48		145 7750	Pressure relief valve, complete
49		144 6030	Sealing ring
50		143 5667	Connecting nipple
51		143 5648	Spacer cage
52		143 5647	Rod seal
53 •		145 7694	Control piston
54		143 5675	Piston seal
55		143 7693	Piston housing
56		143 5688	O-ring
57	T1	144 6026	Stopper 1
	T2	144 6073	Stopper 2
	T3, T4	144 6100	Stopper 3
58		144 5773	Housing screw short
59		143 5486	O-ring
60		143 5492	Al nut
61 •	T1	145 7751	Air piston 1, complete
	T2	145 7860	Air piston 2, complete
	T3	145 7952	Air piston 3, complete
	T4	145 7994	Air piston 4, complete
62 •	T1	143 5658	Piston seal
	T2, T3	143 5841	Piston seal
	T4	143 6007	Piston seal
63 •	T1	143 5657	Guide ring 1
	T2, T3	143 5825	Guide ring 2
	T4	143 6006	Guide ring 4
64 •	T1	143 5656	Piston seal
65 •	T2, T3	143 5670	Piston seal
	T1	143 5660	O-ring
	T2	143 5834	O-ring
66	T3, T4	143 5937	O-ring
	T1	143 5659	Rod seal
67	T1	144 6027	Snap ring
	T2, T3, T4	144 6082	V-profile ring
68	T1	143 5680	O-ring
	T2	143 5839	O-ring
	T3, T4	143 5927	O-ring
69	T1	145 7752	Cylinder 1, complete
	T2	145 7861	Cylinder 2, complete
	T3	145 7953	Cylinder 3, complete
	T4	145 7995	Cylinder 4, complete
70	T1	143 5508	Bottom 1
	T2	143 5761	Bottom 2
	T3, T4	143 5874	Bottom 3
71	T1	143 6394	Rubber foot 1
	T2	143 6371	Rubber foot 2
	T3, T4	143 5900	Rubber foot 3 - 4
	T2, T3	145 7863	Jaw pusher changeover set
	T1	145 7700	Changeover set
	T2, T3, T4	145 7703	Changeover set
		144 5294	Hydraulic oil refill bottle, 100 ml

• Wearing parts

\* Up to and including tools manufactured in September 2015.

You will find spare part kits for TAURUS® 1-4 on page 355.  
You will find detailed nosepiece allocation tables on page 130.



# HYDRO-PNEUMATIC BLIND RIVET SETTING TOOLS

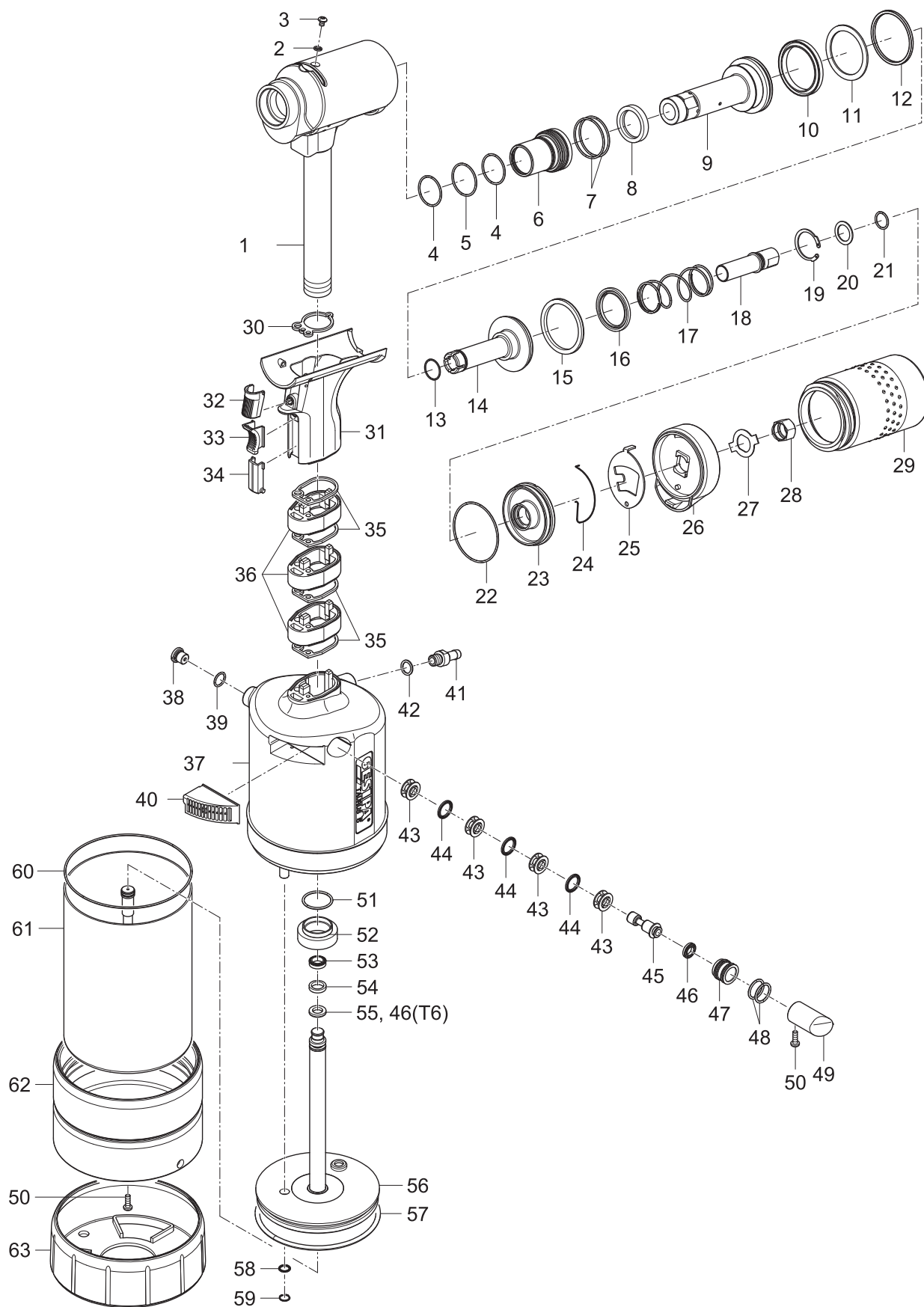

## TAURUS® 5-6



# HYDRO-PNEUMATIC BLIND RIVET SETTING TOOLS

## TAURUS® 5-6

		No.	
1	<b>T5</b>	145 8010	Tool head 5, assembled
	<b>T6</b>	145 8023	Tool head 6, assembled
2		143 5612	Sealing ring M4
3		144 6013	Oil screw plug
4		143 6044	O-ring
5 •		143 6045	O-ring
6		145 8011	Seal holder, complete
7 •		143 6047	O-ring
8 •		143 6048	Rod seal
9		143 6036	Draw bar
10 •		143 6049	Cylinder seal
11 •		143 6052	Supporting ring
12 •		143 6051	Piston seal
13		143 6046	O-ring
14		145 8012	Resetting piston, complete
15		143 6050	Lip ring
16 •		143 6053	Rod seal
17		144 6123	Spring
18		143 6030	Connecting piece
19		144 6124	V-profile ring
20		144 6125	Washer
21		143 6042	O-ring
22		143 6043	O-ring
23		143 6034	End cap
24		144 6122	Retaining spring
25		143 6026	Retainer
26		143 6028	Adapter
27		143 6025	Lock washer
28		143 6029	Connecting piece nut
29		143 6058	Spent mandrel container, complete
30 •		143 5472	Flat gasket 1
31		145 7748	Grip, complete
32		144 6025	Activation button
33		143 5642	Slider
34		143 5686	Orifice
35 •		143 5480	Flat gasket 2
36		143 5998	Grip extension

		No.	
37	<b>T5</b>	145 8013	Air cylinder 5, complete
	<b>T6</b>	146 4043	Air cylinder 6, complete
38		145 7750	Pressure relief valve, complete
39		143 5484	O-ring
40		145 7956	Silencer 3, complete
41		144 6030	Seal
42		143 5667	Connecting nipple
43		143 5648	Spacer cage
44		143 5647	Rod seal
45		143 5651	Control piston
46 •		143 5675	Piston seal
47		143 5652	Piston housing
48		143 5688	O-ring
49		144 5773	Housing screw, short
50		144 6100	Stopper 3
51		143 5486	O-ring
52		143 5492	Al nut
53 •	<b>T5</b>	143 6056	Cylinder seal
	<b>T6</b>	143 6007	Piston seal
54 •	<b>T5</b>	143 6040	Guide ring 5
	<b>T6</b>	143 6006	Guide ring 4
55 •	<b>T5</b>	143 6055	Lip ring
56	<b>T5</b>	145 8015	Air piston 5, complete
	<b>T6</b>	145 8024	Air piston 6, complete
57 •		143 5937	O-ring
58		143 5635	Rod seal
59		144 6082	V-profile ring
60		143 5927	O-ring
61	<b>T5</b>	145 8014	Cylinder 5, complete
	<b>T6</b>	146 4044	Cylinder 6, complete
62		143 6027	Al bottom
63		143 5900	Rubber foot
		144 5294	Hydraulic oil refill bottle, 100 ml

• Wearing parts

# HYDRO-PNEUMATIC BLIND RIVET SETTING TOOLS

## TAURUS® 1-4 AV

**!** You will find detailed nosepiece allocation tables on page 130.

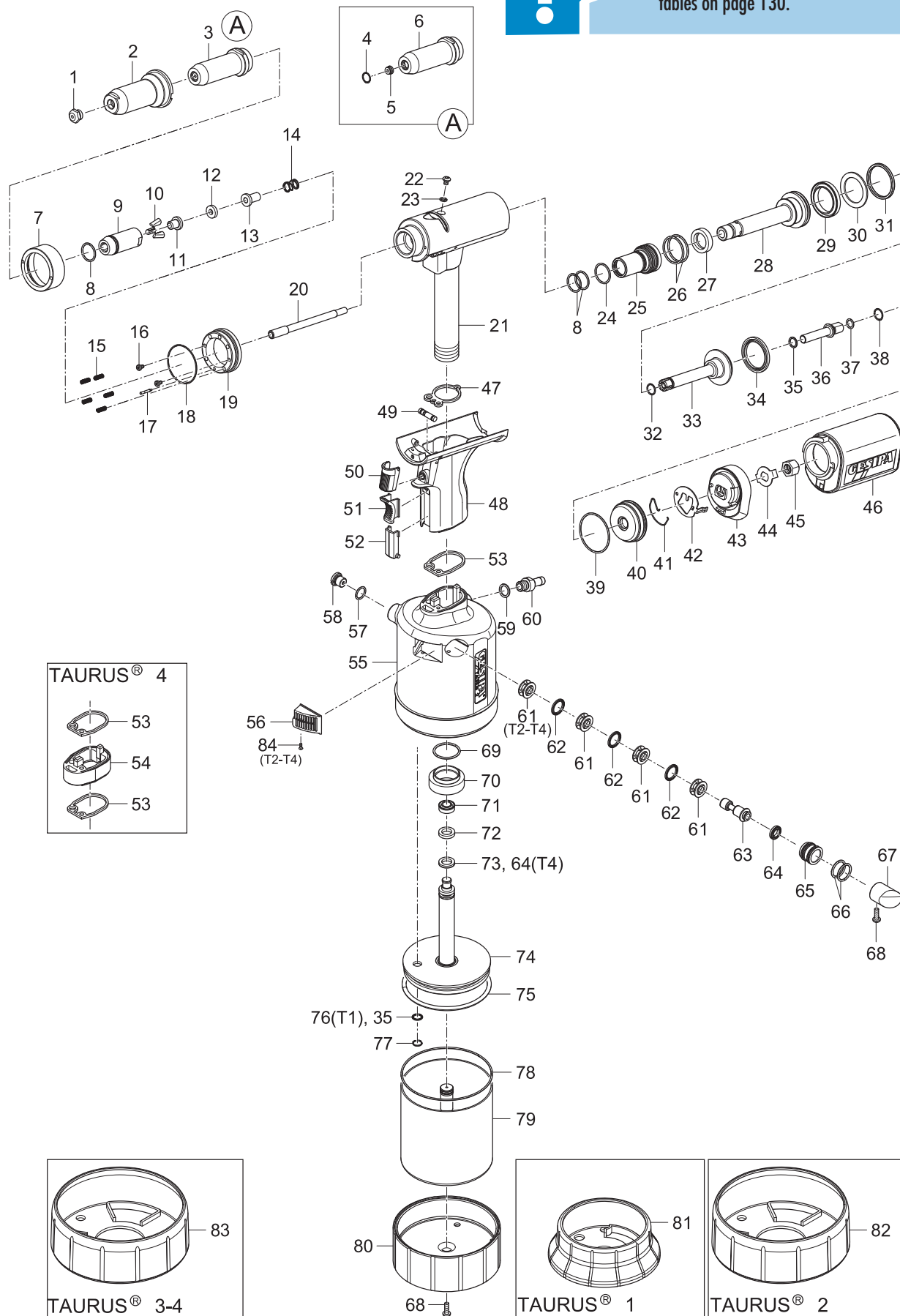



# HYDRO-PNEUMATIC BLIND RIVET SETTING TOOLS

## TAURUS® 1-4 AV

📍	🔧	No.	🔗
1 •	T1	143 5591	Nosepiece 17/18 AV
		143 4990	Nosepiece 17/20 AV
		143 4991	Nosepiece 17/22 AV
	T2	143 5592	Nosepiece 17/24 AV
		143 5593	Nosepiece 17/27 AV
		143 5594	Nosepiece 17/29 AV
		143 5595	Nosepiece 17/32 AV
		143 5596	Nosepiece 17/36 AV
		143 5597	Nosepiece 17/40 AV
	T3, T4	143 5598	Nosepiece 17/45 AV
143 5466		Steel head sleeve	
2			
3	T1	145 0887	Support sleeve AV complete
	T2	145 0943	Support sleeve AV complete
	T3, T4	145 0978	Support sleeve AV complete
4 •		144 6010	Snap ring
5 •	T1	143 5599	Nosepiece Ø 2,5
	T2	143 5600	Nosepiece Ø 3,2
	T3, T4	143 5601	Nosepiece Ø 4,5
6		143 5467	Support sleeve AV
7		143 5499	Union nut
8		144 6012	O-ring
9		143 6002	Jaw housing 4
10 •		143 5568	Jaws (3-part)
11 •	T1	143 5507	Jaw Pusher 1
	T2	143 5768	Jaw Pusher 2
	T3, T4	143 6000	Jaw Pusher 4
12		143 5999	Damping ring 4
13	T1	143 5509	Centre part 1
	T2	143 5769	Centre part 2
	T3, T4	143 6001	Centre part 4
14 •		146 3064	Spring
15 •		144 5994	Spring
16		144 5995	Allen screw
17		152 4521	Stamp
18		143 5529	O-ring
19		143 5498	Casing
20	T1	143 5558	Nozzle tube 1
	T2	143 5764	Nozzle tube 2, long
	T3, T4	143 5886	Nozzle tube 3, long
21	T1	145 7696	Tool head, assembled
	T2, T3	145 7842	Tool head, assembled
	T4	145 7996	Tool head, assembled
22		144 6013	Oil screw plug
23		143 5612	Sealing ring M4
24 •		143 5629	O-ring
25		143 5681	Seal holder, complete
26 •		143 4227	O-ring
27 •		143 5630	Rod seal
28		143 5631	Draw bar
29 •		143 5632	Piston seal
30 •		143 5488	Supporting ring
31 •		143 5485	Piston seal
32 •		143 5671	O-ring
33		145 7746	Resetting piston, complete
34 •		143 5633	Piston seal
35 •		143 5635	Rod seal
36	T1	143 5852	Connecting piece 1
	T2, T3, T4	143 5765	Connecting piece 2/3
37		143 5519	O-ring
38		144 6167	Snap ring
39		143 5524	O-ring
40		143 5532	End cap
41		144 6028	Retaining spring
42		143 5664	Retainer
43		143 5663	Adapter
44		143 5842	Lock washer
45	T1	143 5849	Connecting piece nut 1
	T2, T3, T4	143 5766	Connecting piece nut 2/3

📍	🔧	No.	🔗
46	T1, T2	143 5677	Spent mandrel container, complete
	T3, T4	143 5964	Spent mandrel container, complete
47 •		143 5472	Flat gasket 1
48		143 7695	Grip, complete
49		145 7747	Distributing valve
50		144 6025	Activation button
51		143 5642	Slider
52		143 5686	Orifice
53 •		143 5480	Flat gasket 2
		143 5998	Grip extension
55	T1	145 7749	Air cylinder, complete
	T2	145 7859	Air cylinder, complete
	T3	145 7950	Air cylinder, complete
	T4	145 7993	Air cylinder, complete
56	T1	151 5051	Silencer complete
	T2	145 7862	Silencer complete
	T3, T4	145 7956	Silencer complete
57		145 7750	Pressure relief valve
58		143 5484	O-ring
59		143 5667	Connecting nipple
60		144 6030	Sealing ring
61		143 5648	Spacer cage
62 •		143 5647	Rod seal
63		143 5651	Control piston
64 •		143 5675	Piston seal
65		143 5652	Piston housing
66 •		143 5688	O-ring
	T1	144 6026	Stopper 1
67	T2	144 6073	Stopper 2
	T3, T4	144 6100	Stopper 3
		144 5773	Housing screw short
68		143 5486	O-ring
69		143 5492	Alu nut
71 •	T1	143 5658	Piston seal
	T2, T3	143 5841	Piston seal
	T4	143 6007	Piston seal
72 •	T1	143 5657	Guide ring
	T2, T3	143 5825	Guide ring
	T4	143 6006	Guide ring
73 •	T1	143 5656	Piston seal
	T2, T3	143 5670	Piston seal
74	T1	145 7751	Air piston complete
	T2	145 7860	Air piston complete
	T3	145 7952	Air piston complete
	T4	145 7994	Air piston complete
75 •	T1	143 5660	O-ring
	T2	143 5834	O-ring
	T3, T4	143 5937	O-ring
76		143 5659	Rod seal
77	T1	144 6027	Snap ring
	T2, T3, T4	144 6082	V-ring
78	T1	143 5680	O-ring
	T2	143 5839	O-ring
	T3, T4	143 5927	O-ring
79	T1	145 7752	Cylinder complete
	T2	145 7861	Cylinder complete
	T3	145 7953	Cylinder complete
	T4	145 7995	Cylinder complete
80	T1	143 5508	Bottom
	T2	143 5761	Bottom
	T3, T4	143 5874	Bottom
81		143 6394	Rubber foot
82		143 6371	Rubber foot
83		143 5900	Rubber foot
84		144 6089	Screw
		144 5294	Hydraulic oil refill bottle 100 ml

• Wearing parts

# ACCESSORIES FOR TAURUS® BLIND RIVET SETTING TOOLS

## Repair tools for TAURUS®

Part no. 145 7735

No.	
143 5672*	Allen key
143 5673	Clamp element for Taurus tool head
143 5674*	Assembly device
144 6031*	Slot wrench

\*These tools are also suitable for FireFox® 1 F - 2

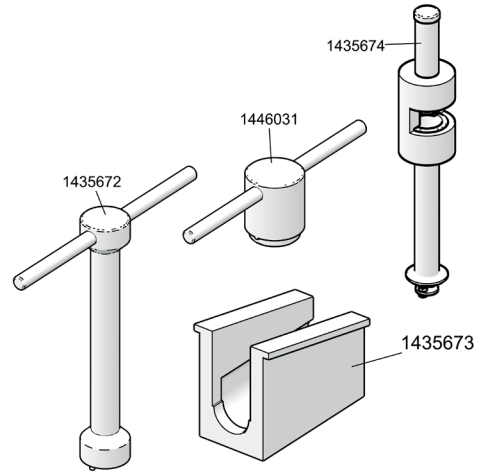

## Changeover set spent mandrel container

for TAURUS® 1:

Part no. 145 7700

for TAURUS® 2,3,4:

Part no. 145 7703

No.	
143 4233	Spent mandrel container
143 5521	Cover
144 5295	Air deflector
145 7701	End cap T 1, complete
145 7702	End cap T 2, 3 and 4, complete

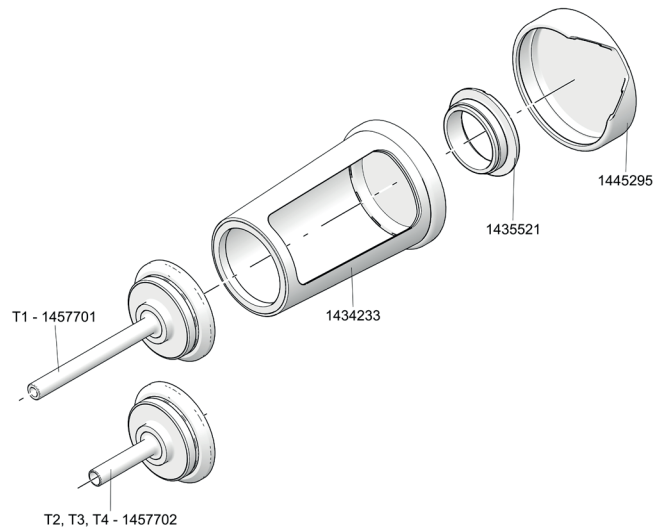



## Rivet counter sensor changeover set for TAURUS® 1-4

for TAURUS® 1

Part no. 145 7698

for TAURUS® 2-4

Part no. 151 6858

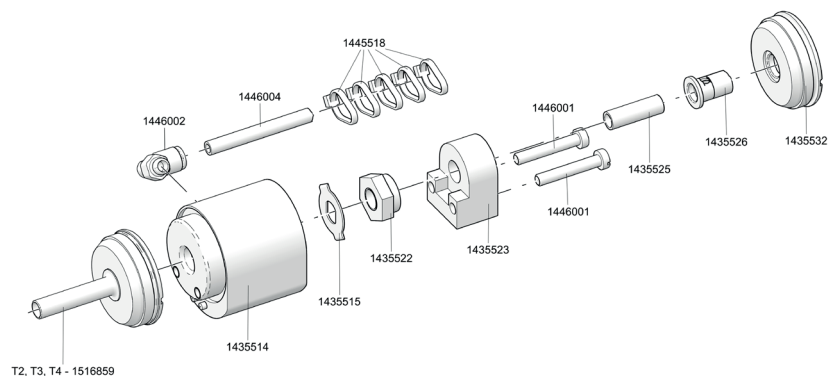

	No.	
	143 5514	Housing
	143 5515	Locking washer
	143 5522	Nut
	143 5523	Ring sensor
	143 5525	Tube
	143 5526	Connecting piece
	143 5532	End cap
	144 5518	Cable tie
	144 6001	Allen screw
	144 6002	Screw connection
	144 6004	Hose
<b>T2, T3, T4</b>	151 6859	End cap



## One-piece extension units

### Extension unit for TAURUS® 1- 4

for TAURUS® 1	<b>+35 mm:</b>	<b>Part no.</b>	<b>146 4345</b>
for TAURUS® 1	<b>+85 mm:</b>	<b>Part no.</b>	<b>146 4346</b>
for TAURUS® 1	<b>+135 mm:</b>	<b>Part no.</b>	<b>146 4347</b>
for TAURUS® 2	<b>+35 mm:</b>	<b>Part no.</b>	<b>145 8042</b>
for TAURUS® 2	<b>+85 mm:</b>	<b>Part no.</b>	<b>146 4350</b>
for TAURUS® 2	<b>+135 mm:</b>	<b>Part no.</b>	<b>146 4351</b>
for TAURUS® 2	<b>+185 mm:</b>	<b>Part no.</b>	<b>146 4352</b>
for TAURUS® 3 and 4	<b>+35 mm:</b>	<b>Part no.</b>	<b>145 7932</b>
for TAURUS® 3 and 4	<b>+85 mm:</b>	<b>Part no.</b>	<b>145 7933</b>
for TAURUS® 3 and 4	<b>+135 mm:</b>	<b>Part no.</b>	<b>145 7937</b>

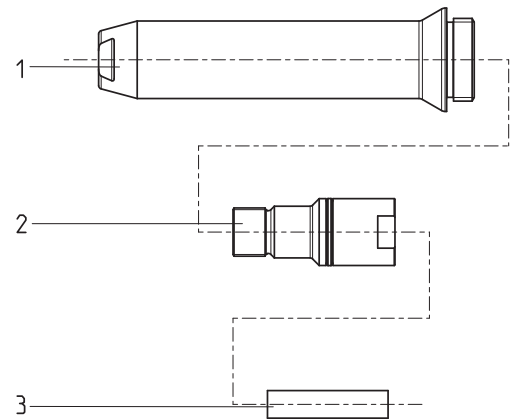

			No.	
TAURUS® 1	+35 mm	1	143 5473	Steel head sleeve
		2	145 7938	Adapter
		3	146 4338	Jaw pusher
	+85 mm	1	143 5476	Steel head sleeve
		2	145 7939	Adapter
		3	146 4339	Jaw pusher
	+135 mm	1	143 5487	Steel head sleeve
		2	143 5890	Adapter
		3	143 5544	Jaw pusher
TAURUS® 2	+35 mm	1	143 5473	Steel head sleeve
		2	145 7938	Adapter
		3	143 6100	Jaw pusher
	+85 mm	1	143 5476	Steel head sleeve
		2	145 7939	Adapter
		3	143 5819	Jaw pusher
	+135 mm	1	143 5487	Steel head sleeve
		2	143 5890	Adapter
		3	143 5792	Jaw pusher
	+185 mm	1	143 5801	Steel head sleeve
		2	146 4343	Adapter
		3	146 4340	Jaw pusher
TAURUS® 3 - 4	+35 mm	1	143 5473	Steel head sleeve
		2	145 7938	Adapter
		3	143 5881	Jaw pusher
	+85 mm	1	143 5476	Steel head sleeve
		2	145 7939	Adapter
		3	143 5882	Jaw pusher
	+135 mm	1	143 5487	Steel head sleeve
		2	143 5890	Adapter
		3	143 5879	Jaw pusher





## One-piece extension units

### Extension unit for TAURUS® 1- 4 with spring-loaded trigger system

for TAURUS® 1	<b>50 mm:</b>	<b>Part no.</b>	<b>145 0880</b>
for TAURUS® 1	<b>100 mm:</b>	<b>Part no.</b>	<b>145 7727</b>
for TAURUS® 2	<b>50 mm:</b>	<b>Part no.</b>	<b>145 7857</b>
for TAURUS® 2	<b>100 mm:</b>	<b>Part no.</b>	<b>145 7858</b>
for TAURUS® 3 and 4	<b>50 mm:</b>	<b>Part no.</b>	<b>145 7959</b>
for TAURUS® 3 and 4	<b>100 mm:</b>	<b>Part no.</b>	<b>145 7960</b>

			No.	
TAURUS® 1	50 mm	1	143 5591	Nosepiece 17/18 AV
			143 4990	Nosepiece 17/20 AV
			143 4991	Nosepiece 17/22 AV
		2	143 5870	Steel head sleeve AV
		3	145 0888	Support sleeve AV,complete
		4	145 7737	Adapter, complete
		5	143 5553	Intermediate bush 1
		6	144 6010	Snap ring
	7 •	143 5599	Nosepiece	
	8	143 5871	Support sleeve AV,complete	
	100 mm	1	143 5591	Nosepiece 17/18 AV
			143 4990	Nosepiece 17/20 AV
			143 4991	Nosepiece 17/22 AV
		2	143 5872	Steel head sleeve AV
		3	145 0889	Support sleeve AV,complete
		4	145 7739	Adapter, complete
5		143 5556	Intermediate bush 1	
6		144 6010	Snap ring	
7 •	143 5599	Nosepiece		
8	143 5873	Support sleeve AV,complete		
TAURUS® 2	50 mm	1	143 5592	Nosepiece 17/24 AV
			143 5593	Nosepiece 17/27 AV
			143 5594	Nosepiece 17/29 AV
			143 5595	Nosepiece 17/32 AV
		2	143 5870	Steel head sleeve AV
		3	145 0944	Support sleeve AV,complete
		4	145 7737	Adapter, complete
		5	143 5798	Intermediate bush 2
	6	144 6010	Snap ring	
	7 •	143 5600	Nosepiece	
	8	143 5871	Support sleeve AV,complete	
	100 mm	1	143 5592	Nosepiece 17/24 AV
			143 5593	Nosepiece 17/27 AV
			143 5594	Nosepiece 17/29 AV
			143 5595	Nosepiece 17/32 AV
		2	143 5872	Steel head sleeve AV
3		145 0945	Support sleeve AV,complete	
4		145 7739	Adapter, complete	
5		143 5797	Intermediate bush 2	
6	144 6010	Snap ring		
7 •	143 5600	Nosepiece		
8	143 5873	Support sleeve AV,complete		

			No.	
TAURUS® 3 - 4	50 mm	1	143 5596	Nosepiece 17/36 AV
			143 5597	Nosepiece 17/40 AV
			143 5598	Nosepiece 17/45 AV
		2	143 5870	Steel head sleeve AV
		3	145 0979	Support sleeve AV,complete
		4	145 7737	Adapter, complete
		5	143 5902	Intermediate bush 3/4
		6	144 6010	Snap ring
	7 •	143 5601	Nosepiece	
	8	143 5871	Support sleeve AV,complete	
	100 mm	1	143 5596	Nosepiece 17/36 AV
			143 5597	Nosepiece 17/40 AV
			143 5598	Nosepiece 17/45 AV
		2	143 5872	Steel head sleeve AV
		3	145 0980	Support sleeve AV,complete
		4	145 7739	Adapter, complete
5		143 5903	Intermediate bush 3/4	
6		144 6010	Snap ring	
7 •	143 5601	Nosepiece		
8	143 5873	Support sleeve AV,complete		

• Wearing parts

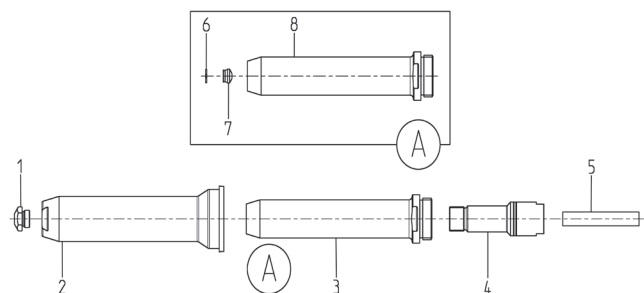



# ACCESSORIES FOR TAURUS® BLIND RIVET SETTING TOOLS

## Multi-piece extension units

arbitrary extension of the tool head in 100 mm steps

### Extension modules for TAURUS® 1- 4

for TAURUS® 1: Part no. 145 7743  
 for TAURUS® 2: Part no. 145 7848  
 for TAURUS® 3 and 4: Part no. 145 7947

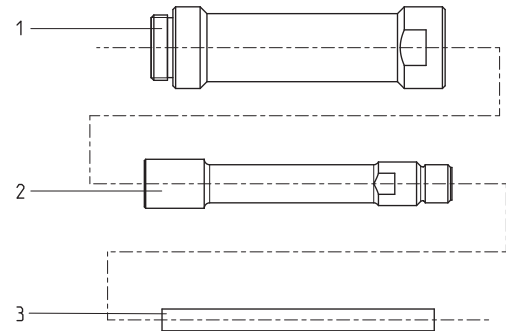

		No.	
TAURUS® 1	1	143 4995	Extension sleeve
	2	143 4165	Extension piece
	3	143 5556	Intermediate bush
TAURUS® 2	1	143 4995	Extension sleeve
	2	143 4165	Extension piece
	3	143 5797	Intermediate bush
TAURUS® 3 - 4	1	143 4995	Extension sleeve
	2	143 4165	Extension piece
	3	143 5903	Intermediate bush



## Heads for TAURUS® 5-6

for 7.8mm (5/16") TIBULB structure rivet

Part no. 145 8008

	No.	
1	145 8016	Nozzle tube, complete
2	143 6064	Damping ring
3 •	143 6068	Jaw pusher
4 •	143 5568	Jaw**
5 •	143 6070	Jaw housing
6	143 6069	Centre part
7 •	143 6067	Nosepiece 18/53
8	143 6059	Steel head sleeve
9 •	143 6044	O-ring

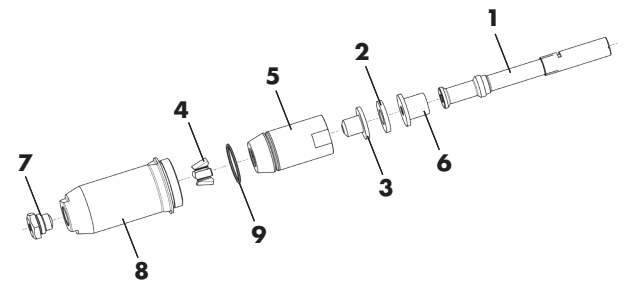



• Wearing parts

\*\* For changing the complete set you have to order 4 Jaws

## for 9.8mm (3/8") Magna-Lok® structure rivet

Artikel-Nr. 145 8009

	No.	
1	143 6065	Nozzle tube, complete
2	143 6064	Damping ring
3 •	143 6061	Jaw pusher
4 •	143 6066	Jaws, 3-part
5 •	143 6063	Jaw housing
6	143 6062	Centre part
7 •	143 6060	Nosepiece 18/63
8	143 6059	Steel head sleeve
9 •	143 6044	O-ring

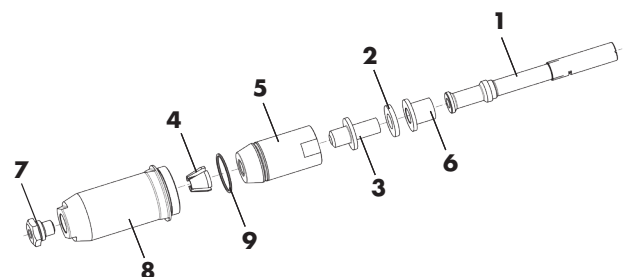

• Wearing parts

## Angle heads for TAURUS® blind rivet setting tools

### Angle head 90° compact for TAURUS® 1-2

Part no. 145 7921

No.	
143 4104*	Jaws (3-part)
143 4977*	Nosepiece 17/36
143 4992*	Jaw Pusher
143 5908	Bolt
143 5911	Axis bolt
143 5914	Spacer
143 5918*	Jaw housing
143 5919	Fork head
143 5926	Steel head sleeve
143 5935	Coupler
143 5936	Angle
143 5938	Lock activator
143 5940	Lock activator
143 5952	Ring
143 5959	Adapter
143 5963	Protecting cap
144 5545	Snap ring
144 5747*	Spring
144 6012*	O-ring
144 6013	Screw
145 0977	Housing

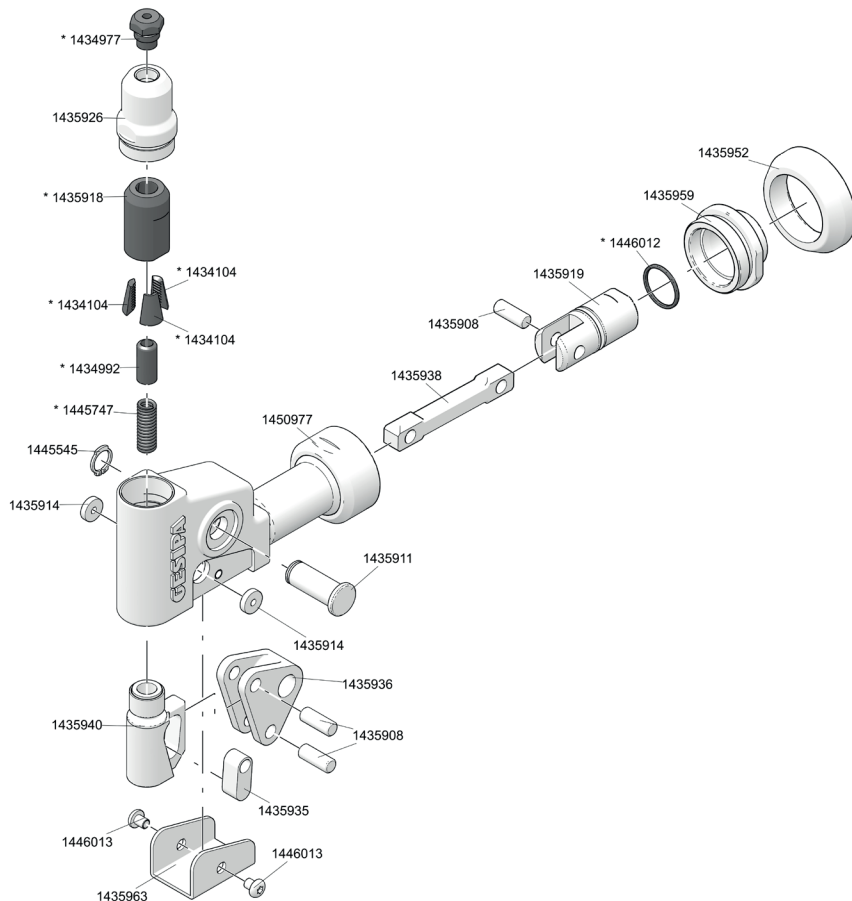

\* Wearing parts



\* Wearing parts

## Angle heads for TAURUS® blind rivet setting tools

### Angle head 90° compact for 1, 2, 4 & TAURUS® 3

No.		
143 3543		Coupler
143 3544	<b>T3</b>	Angle
143 3545	<b>T3</b>	Lock activator
143 4106*		Jaw Pusher
143 4173*		Jaws (3-part)
143 4860*		Nosepiece 17/45 for angle head
143 4958*		Jaws (3-part) up to rivet Ø 4mm (Nosepiece 17/24)
143 5603 *		O-ring
143 5946*		Jaw housing
143 5947		Spacer
143 5948		Bolt
143 5950		Axis bolt
143 5951		Fork head
143 5952		Ring
143 5954		Protecting cap
143 5955		Steel head sleeve
143 5958	<b>T1, T2, T4</b>	Lock activator
143 5959		Adapter
144 5258*		Spring
144 6013		Screw
144 6106		Snap ring
145 7961		Housing
155 9510	<b>T1, T2, T4</b>	Angle
155 9511		Lock activator

#### \* Wearing parts

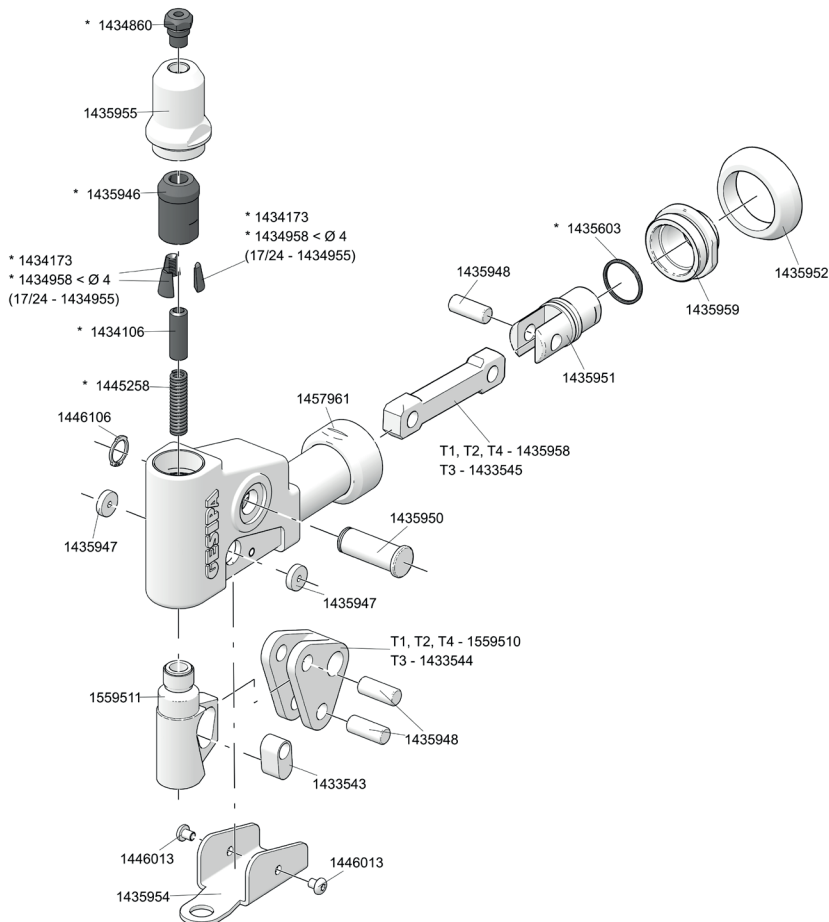

#### \* Wearing parts

# HYDRO-PNEUMATIC BLIND RIVET SETTING TOOLS

## TAUREX 1-4

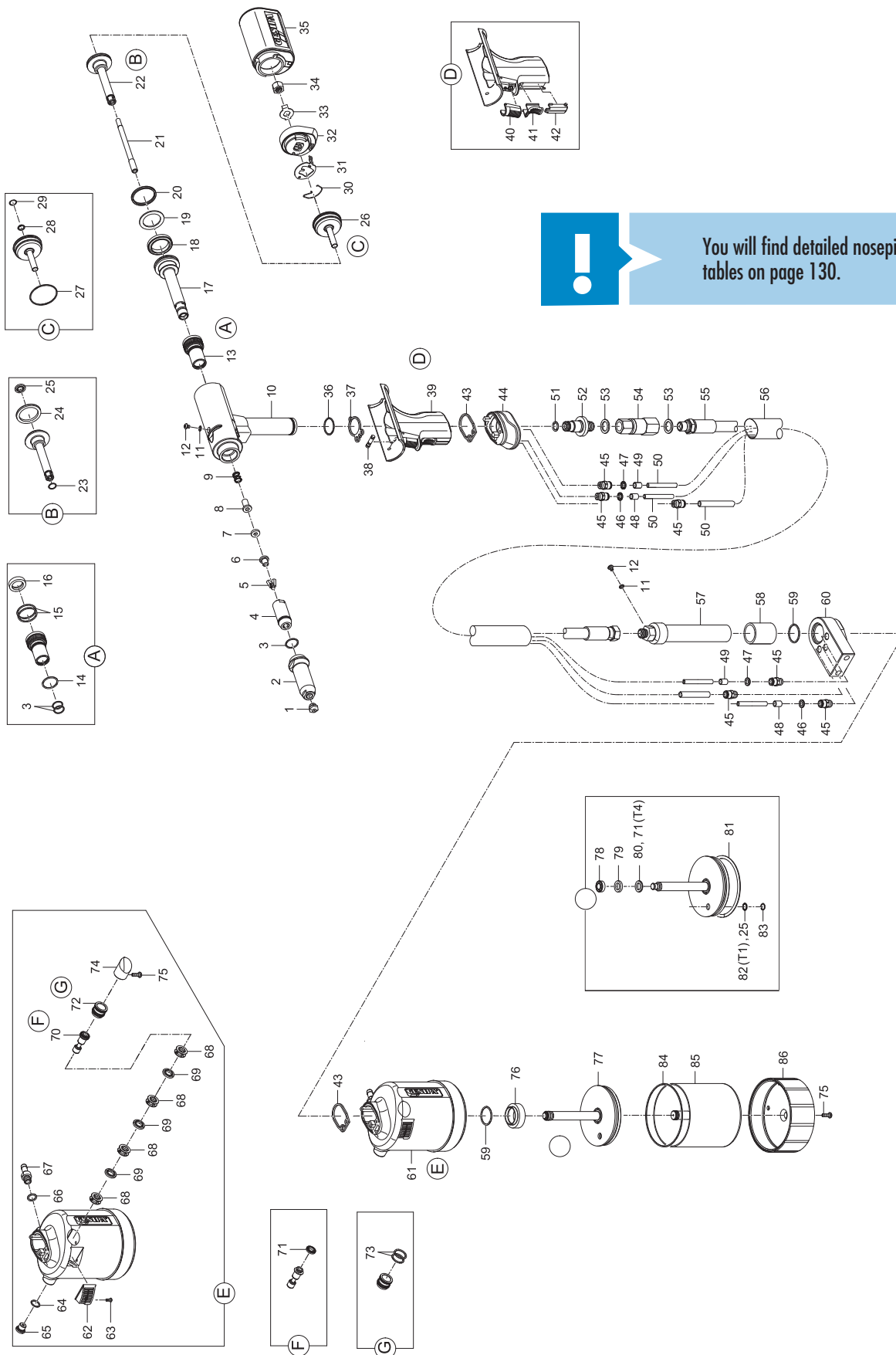







**You will find detailed nosepiece allocation tables on page 130.**



# HYDRO-PNEUMATIC BLIND RIVET SETTING TOOLS

## TAUREX 1-4

		No.		
1 •	T1	143 4976	Nosepiece 17/18	
		143 4994	Nosepiece 17/20	
		143 5018	Nosepiece 17/22	
	T2	143 4955	Nosepiece 17/24	
		143 4973	Nosepiece 17/27	
		143 4974	Nosepiece 17/29	
		143 4975	Nosepiece 17/32	
	T3, T4	143 4977	Nosepiece 17/36	
		143 4999	Nosepiece 17/40	
		143 4860	Nosepiece 17/45	
	2		143 6003	Steel head sleeve 4
	3 •		144 6012	O-ring
	4 •		143 6002	Jaw housing 4
5 •		143 5568	Jaw	
6 •	T1	143 5507	Jaw pusher AV1	
	T2	143 5768	Jaw pusher AV2	
	T3, T4	143 6000	Jaw pusher 4	
7		143 5999	Damping ring 4	
8	T1	143 5509	Centre part AV1	
	T2	143 5769	Centre part AV2	
	T3, T4	143 6001	Centre part 4	
9		146 3064	Spring	
10		145 8029	Tool head, assembled	
11		143 5612	Sealing ring M4	
12		144 6013	Oil screw plug	
13		143 5681	Seal holder, complete	
14 •		143 5629	O-ring	
15 •		143 4227	O-ring	
16 •		143 5630	Rod seal	
17		143 5631	Draw bar	
18 •		143 5488	Supporting ring	
19 •		143 5485	Piston seal	
20 •		143 5632	Piston seal	
21	T1	143 5558	Nozzle tube 1	
	T2	143 5764	Nozzle tube 2, long	
	T3, T4	143 5886	Nozzle tube 3, long	
22		145 7746	Resetting piston, complete	
23		143 5671	O-ring	
24 •		143 5633	Piston seal	
25		143 5635	Rod seal	
26	T1	145 1223	End cap	
	T2, T3, T4	145 7840	End cap	
27		143 5524	O-ring	
28		143 5519	O-ring	
29		144 6167	Snap ring	
30		144 6028	Retaining spring	
31		143 5664	Retainer	
32		143 5663	Adapter	
		143 5842	Lock washer	
34	T1	143 5849	Supporting nut 1	
	T2, T3, T4	143 5766	Supporting nut 2/3	
35	T1, T2	143 5677	Spent mandrel container, complete	
	T3, T4	143 5964	Spent mandrel container, complete	
36		143 5590	O-ring	
37 •		143 5472	Flat gasket 1	
38		145 7747	Distributing valve complete	
39		145 7748	Grip complete	
40		144 6025	Activation button	
41		143 5642	Valve	
42		143 5686	Orifice	
43 •		143 5480	Flat gasket 2	
44		144 6126	Head adapter	
45		144 6130	Screw-in connection	
46		144 6132	Coding ring, green	
47		144 6133	Coding ring, red	
48		144 5393	PA tube Ø 6 green (L = 10 mm)*	
49		144 5395	PA tube Ø 6 red (L = 10 mm)*	
50		144 6134	PU tube Ø 6mm (L=3.2mm)	
51		143 4496	O-ring	
52		143 6090	Hose connector	

		No.	
53		144 6131	Hydraulic seal rings
54		144 6146	Swivel
55		144 6127	Hydraulic hose
56		144 6135	Hose casing
57	T1	151 3245	Hose connector cylinder
	T2, T3	151 3246	Hose connector cylinder
	T4	151 3247	Hose connector cylinder
58	T1, T2, T3	143 6093	Spacer tube
	T4	143 6102	Spacer tube
59		143 5486	O-ring
60		143 6092	Cylinder adapter
61	T1	145 1010	Air cylinder TAUREX 1
	T2	145 1012	Air cylinder TAUREX 2
	T3	143 6101	Air cylinder TAUREX 3
	T4	145 1024	Air cylinder TAUREX 4
62	T1	151 5051	Silencer 1, complete
	T2	145 7862	Silencer 2, complete
	T3, T4	145 7956	Silencer 3, complete
63	T2, T3, T4	144 6089	Screw
64		143 5484	O-ring
65		145 7750	Pressure relief valve
66		144 6030	Sealing ring
67		143 5667	Connecting nipple
68	T2, T3, T4	143 5648	Spacer cage
69		143 5647	Rod seal
70		145 7694	Control piston
71 •		143 5675	Piston seal
72 •		145 7693	Piston housing
73 •		143 5688	O-ring
74	T1	144 6026	Stopper 1
	T2	144 6073	Stopper 2
	T3, T4	144 6100	Stopper 3
75		144 5773	Housing screw short
76		143 5492	Al nut
77	T1	145 7751	Air piston 1, complete
	T2	145 7860	Air piston 2, complete
	T3	145 7952	Air piston 3, complete
	T4	145 7994	Air piston 4, complete
78 •	T1	143 5658	Piston seal
	T2, T3	143 5841	Piston seal
	T4	143 6007	Piston seal
79 •	T1	143 5657	Guide ring 1
	T2, T3	143 5825	Guide ring 2
	T4	143 6006	Guide ring 4
80 •	T1	143 5656	Piston seal
	T2, T3	143 5670	Piston seal
81 •	T1	143 5660	O-ring
	T2	143 5834	O-ring
	T3, T4	143 5937	O-ring
82 •	T1	143 5659	Rod seal
	T1	144 6027	Snap ring
83	T1, T3, T4	144 6082	V-profile ring
	T1	143 5680	O-ring
84	T2	143 5839	O-ring
	T3, T4	143 5927	O-ring
	T1	145 7752	Cylinder 1, complete
85	T2	145 7861	Cylinder 2, complete
	T3	145 7953	Cylinder 3, complete
	T4	145 7995	Cylinder 4, complete
86	T1	143 5508	Bottom 1
	T2	143 5761	Bottom 2
	T3, T4	143 5874	Bottom 3
		144 5294	Hydraulic oil refill bottle, 100 ml

• Wearing parts

\* The length required must always be specified on the order; the article numbers always refers to the price per metre.



# HYDRO-PNEUMATIC BLIND RIVET SETTING TOOLS

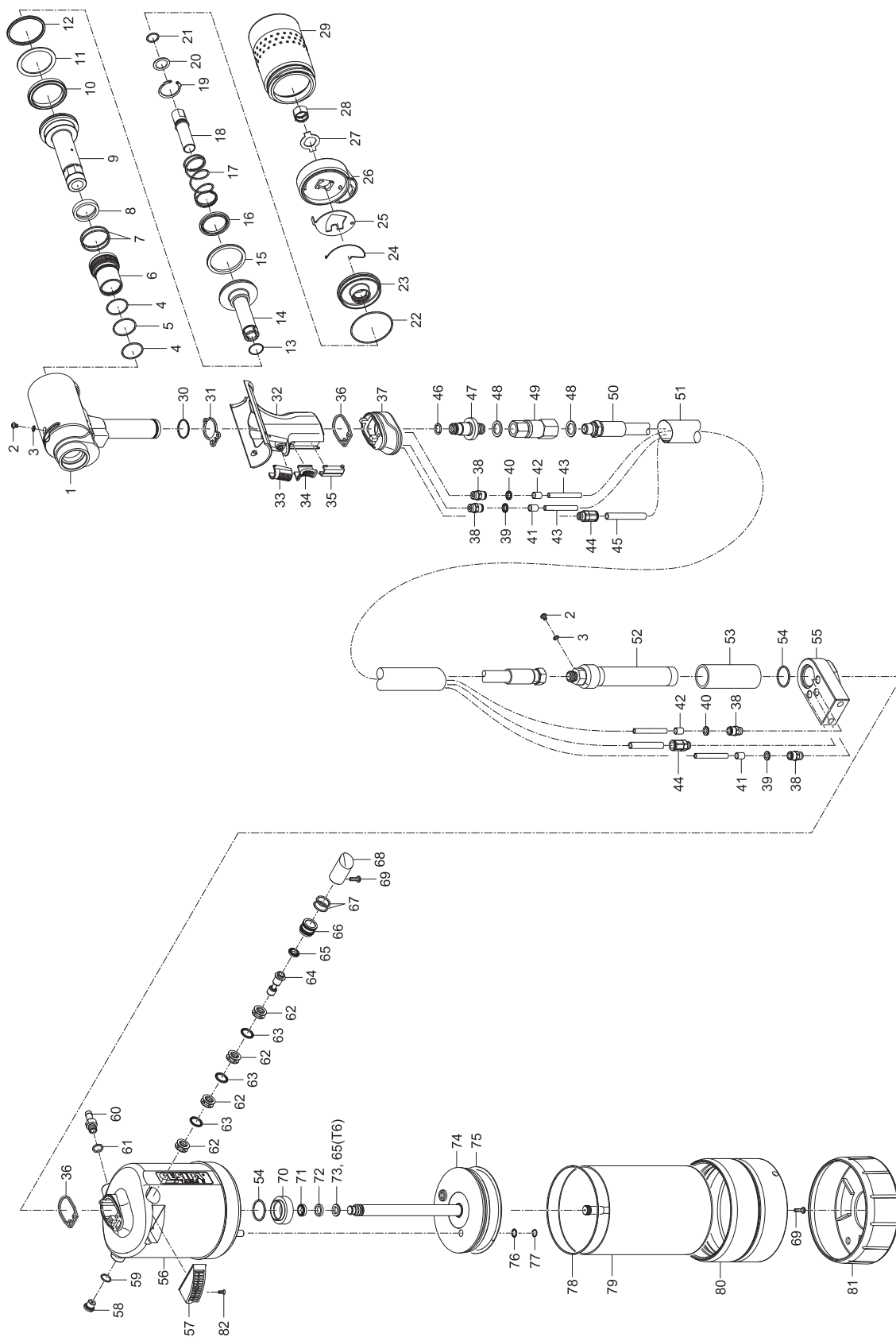

## TAUREX 5-6



# HYDRO-PNEUMATIC BLIND RIVET SETTING TOOLS

## TAUREX 5-6

			
1		145 1025	Tool head, assembled
2		143 5612	Sealing ring M4
3		144 6013	Oil screw plug
4 •		143 6044	O-ring
5 •		143 6045	O-ring
6		143 6035	Seal holder, complete
7 •		143 6047	O-ring
8 •		143 6048	Rod seal
9		143 6036	Draw bar
10 •		143 6049	Cylinder seal
11 •		143 6052	Supporting ring
12 •		143 6051	Piston seal
13 •		143 6046	O-ring
14		145 8012	Resetting piston, complete
15 •		143 6050	Lip ring
16 •		143 6053	Rod seal
17		144 6123	Spring
18		143 6030	Connecting piece
19		144 6124	V-profile ring
20		144 6125	Washer
21		143 6042	O-ring
22		143 6043	O-ring
23		143 6034	End cap
24		144 6122	Retaining spring
25		143 6026	Retainer
26		143 6028	Adapter
27		143 6025	Lock washer
28		143 6029	Connecting piece nut
29		143 6058	Spent mandrel container, complete
30		143 5590	O-ring
31 •		143 5472	Flat gasket
32		145 7748	Grip complete
33		144 6025	Activation button
34		143 5642	Slider
35		143 5686	Orifice
36 •		143 5480	Flat gasket 2
37		144 6126	Head adapter
38		144 6130	Screw-in connection
39		144 6132	Coding ring, green
40		144 6133	Coding ring, red
41		144 5393	PA tube Ø 6 green (L = 10 mm)*
42		144 5395	PA tube Ø 6 red (L = 10 mm)*
43		144 6134	PU tube
44		144 6138	Screw connection
45		144 6137	PU tube
46		143 4496	O-ring

			
47		143 6090	Hose connector
48		144 6131	Hydraulic seal rings
49		144 6146	Swivel
50		144 6127	Hydraulic hose
51		144 6135	Hose casing
52	<b>T5</b>	152 4522	Hose connector cylinder
	<b>T6</b>	152 4523	Hose connector cylinder
53		143 6103	Spacer tube
54		143 6092	Cylinder adapter
55		143 5486	O-ring
56	<b>T5</b>	145 8013	Air cylinder TAUREX 5
	<b>T6</b>	146 4043	Air cylinder TAUREX 6
57		145 7956	Silencer 3, complete
58		145 7750	Pressure relief valve, complete
59		143 5484	O-ring
60		143 5667	Connecting nipple
61		144 6030	Seal
62		143 5648	Spacer cage
63 •		143 5647	Rod seal
64		143 5651	Control piston
65 •		143 5675	Piston seal
66		143 5652	Piston housing
67		143 5688	O-ring
68		144 6100	Stopper 3
69		144 5773	Housing screw, short
70		143 5492	Al nut
71 •	<b>T5</b>	143 6056	Cylinder seal
	<b>T6</b>	143 6007	Piston seal
72 •	<b>T5</b>	143 6040	Guide ring 5
	<b>T6</b>	143 6006	Guide ring 4
73 •	<b>T5</b>	143 6055	Lip ring
74	<b>T5</b>	145 8015	Air piston 5, complete
	<b>T6</b>	145 8024	Air piston 6, complete
75 •		143 5937	O-ring
76 •		143 5635	Rod seal
77		144 6082	V-profile ring
78		143 5927	O-ring
79	<b>T5</b>	145 8014	Cylinder 5, complete
	<b>T6</b>	146 4044	Cylinder 6, complete
80		143 6027	Al bottom
81		143 5900	Rubber foot 3-4
82		144 6089	Screw
		144 5294	Hydraulic oil refill bottle, 100 ml

• Wearing parts

\* The length required must always be specified on the order; the article numbers always refers to the price per metre.



# HYDRO-PNEUMATIC BLIND RIVET SETTING TOOLS

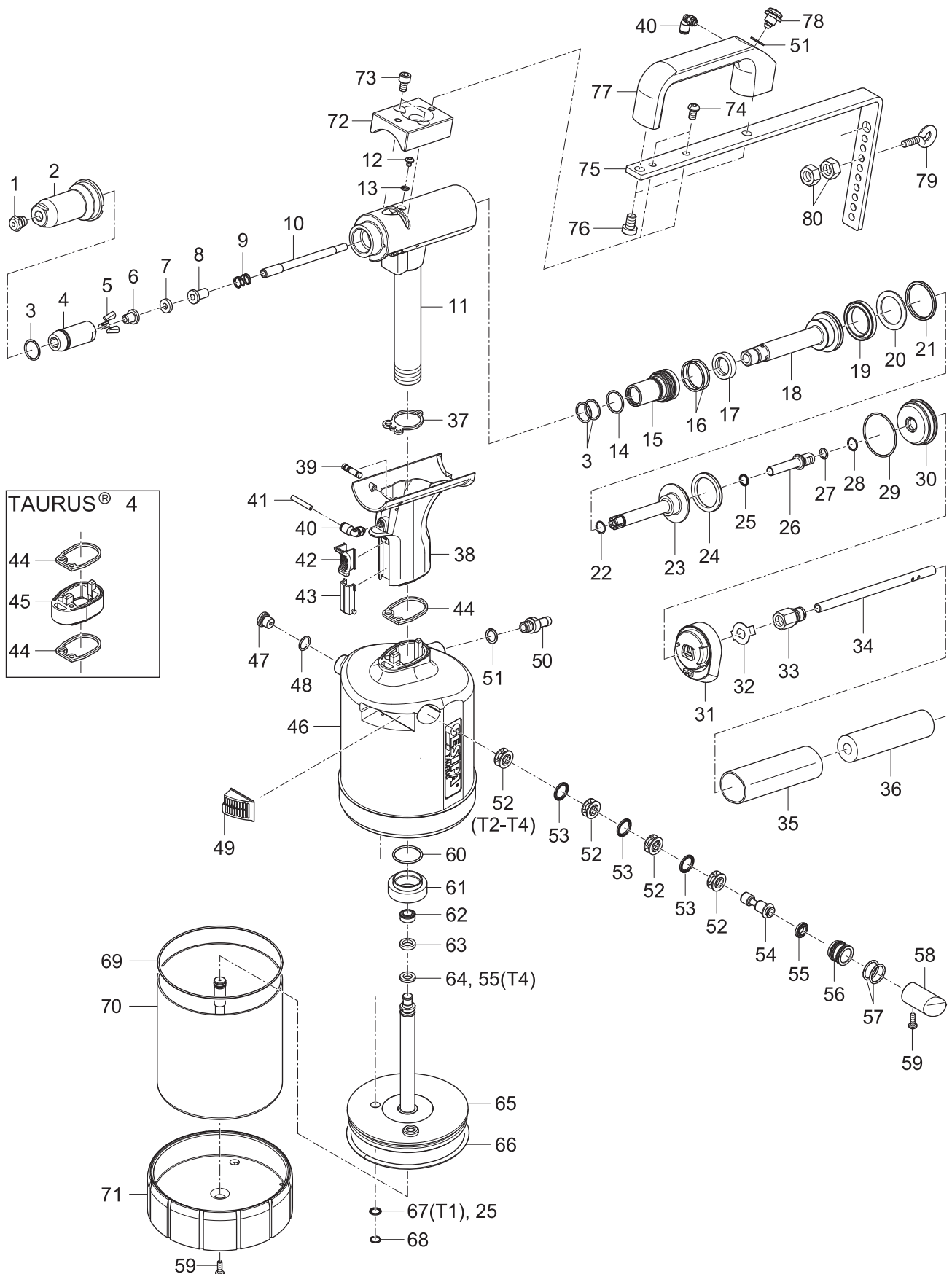

## TAURUS® 1-4 Axial eco



# HYDRO-PNEUMATIC BLIND RIVET SETTING TOOLS

## TAURUS® 1-4 Axial eco

		No.	
1 •	T1	143 4976	Nosepiece 17/18
		143 4994	Nosepiece 17/20
		143 5018	Nosepiece 17/22
	T2	143 4955	Nosepiece 17/24
		143 4973	Nosepiece 17/27
		143 4974	Nosepiece 17/29
		143 4975	Nosepiece 17/32
		143 4977	Nosepiece 17/36
	T3, T4	143 4999	Nosepiece 17/40
		143 4860	Nosepiece 17/45
2		143 6003	Steel head sleeve 4
3 •		144 6012	O-ring
4 •		143 6002	Jaw housing
5 •		143 5568	Jaws (3-part)
6 •	T1	143 5507	Jaw pusher 1
	T2	143 5768	Jaw pusher 2
	T3, T4	143 6000	Jaw pusher 4
7		143 5999	Damping ring 4
8	T1	143 5509	Centre part 1
	T2	143 5769	Centre part 2
	T3, T4	143 6001	Centre part 4
9 •		146 3064	Spring
10	T1	143 5558	Nozzle tube 1
	T2	143 5764	Nozzle tube 2, long
	T3, T4	143 5886	Nozzle tube 3, long
11	T1	145 0876	Tool head 1, assembled
	T2, T3	145 0934	Tool head 2, assembled
	T4	145 7999	Tool head 4, assembled
12		144 6013	Oil screw plug
13		143 5612	Sealing ring
14 •		143 5629	O-ring
15		143 5681	Seal holder, complete
16 •		143 4227	O-ring
17 •		143 5630	Rod seal
18		143 5631	Draw bar
19 •		143 5632	Piston seal
20 •		143 5488	Supporting ring
21 •		143 5485	Piston seal
22 •		143 5671	O-ring
23		145 7746	Resetting piston complete
24 •		143 5633	Piston seal
25 •		143 5635	Rod seal
26	T1	143 5852	Connecting piece 1
	T2, T3, T4	143 5765	Connecting piece 2/3
27		143 5519	O-ring
28		144 6167	Snap ring
29		143 5524	O-ring
30		143 5532	End cap
31		143 5663	Adapter
32		143 5842	Lock washer
33		143 5848	Screw connection
34		143 5767	Hose
35		144 5647	Protective hose
36		143 5579	Foamed material tubes (0,1m)*
37 •		143 5472	Flat gasket 1
38		145 7869	Grip FA, complete
39		145 7747	Distributing valve, complete
40		144 6230	Screw connection
41		144 6134	PU tube 0,2m*
42		143 5642	Slider
43		143 5686	Orifice
44 •		143 5480	Flat gasket 2
45	T4	143 5998	Grip extension

		No.	
46	T1	145 0883	Air cylinder 1 Axial eco
	T2	145 0942	Air cylinder 2 Axial eco
	T3	145 0969	Air cylinder 3 Axial eco
	T4	145 0995	Air cylinder 4 Axial eco
47		145 7750	Pressure relief valve, complete
48		143 5484	O-ring
49	T1	151 5051	Silencer 1, complete
	T2	145 7862	Silencer 2, complete
	T3, T4	145 7956	Silencer 3, complete
50		143 5667	Connecting nipple
51		144 6030	Sealing ring
52		143 5648	Spacer cage
53 •		143 5647	Rod seal
54		143 5651	Control piston
55 •		143 5675	Piston seal
56		143 5652	Piston housing
57		143 5688	O-ring
58	T1	144 6026	Stopper 1
	T2	144 6073	Stopper 2
	T3, T4	144 6100	Stopper 3
59		144 5773	Housing screw, short
60		143 5486	O-ring
61		143 5492	Al nut
62 •	T1	143 5658	Piston seal
	T2, T3	143 5841	Piston seal
63 •	T1	143 6007	Piston seal
	T1	143 5657	Guide ring 1
	T2, T3	143 5825	Guide ring 2
64 •	T4	143 6006	Guide ring 4
	T1	143 5656	Piston seal
65	T2, T3	143 5670	Piston seal
	T1	145 7751	Air piston 1, complete
65	T2	145 7860	Air piston 2, complete
	T3	145 7952	Air piston 3, complete
	T4	145 7994	Air piston 4, complete
	T1	143 5660	O-ring
66 •	T2	143 5834	O-ring
	T3, T4	143 5937	O-ring
67 •	T1	143 5659	Rod seal
68	T1	144 6027	Snap ring
	T2, T3, T4	144 6082	V-profile ring
69	T1	143 5680	O-ring
	T2	143 5839	O-ring
	T3, T4	143 5927	O-ring
70	T1	145 7752	Cylinder 1, complete
	T2	145 7861	Cylinder 2, complete
	T3	145 7953	Cylinder 3, complete
	T4	145 7995	Cylinder 4, complete
71	T1	143 5508	Bottom 1
	T2	143 5761	Bottom 2
	T3, T4	143 5874	Bottom 3
72		143 5538	Holder
73		144 5630	Allen screw
74		144 6087	Fillister head screw
75		143 5836	Hanger
76		144 6085	Allen screw
77		143 5575	Grip
78		145 6753	Valve, complete
79		144 5342	Screw
80		144 5262	Nut
		144 5294	Hydraulic oil refill bottle, 100 ml

• Wearing parts

\* The length required must always be specified on the order; the article numbers always refers to the price per metre.



You will find detailed nosepiece allocation tables on page 130.

# HYDRO-PNEUMATIC BLIND RIVET SETTING TOOLS

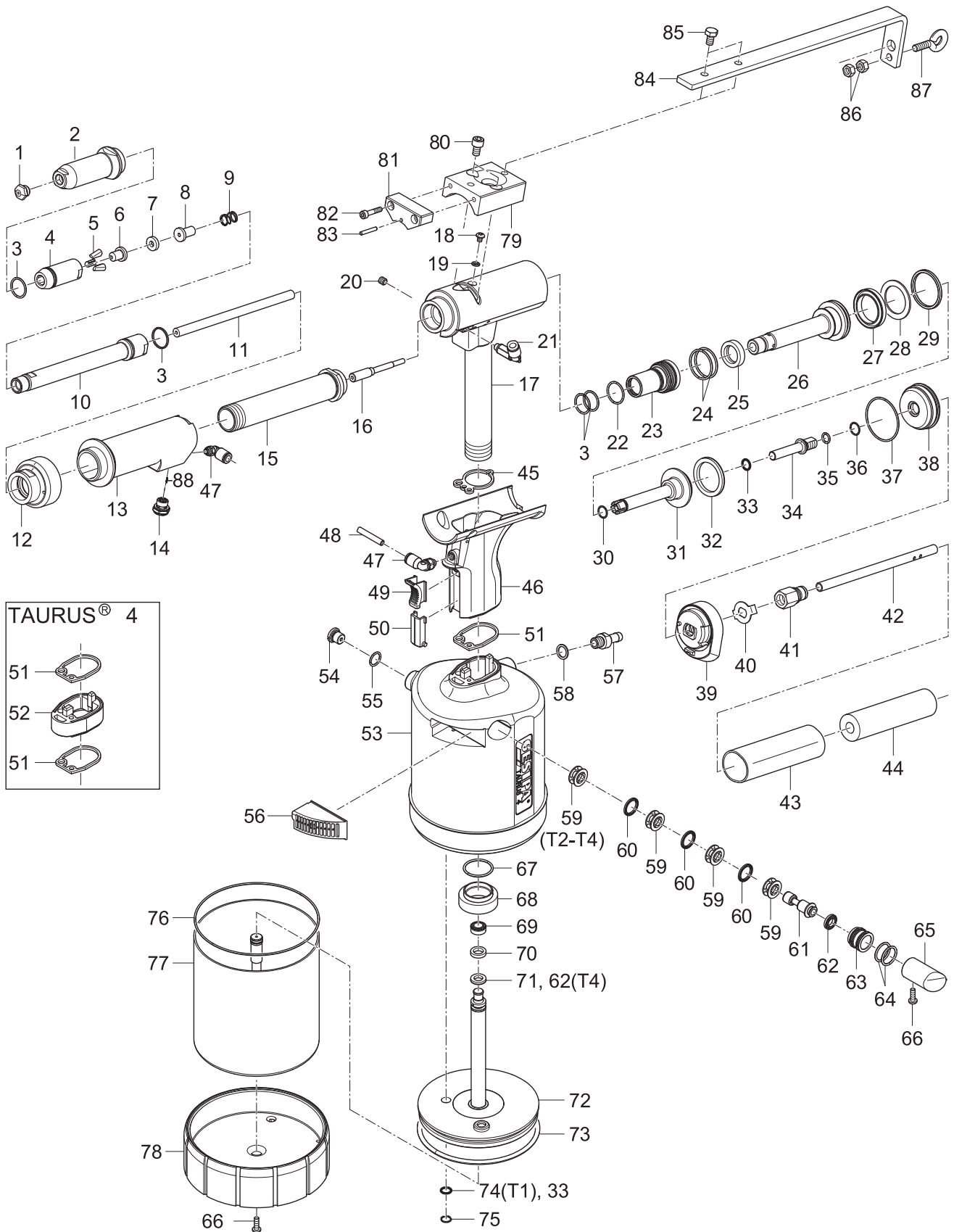

## TAURUS® 1-4 Axial





**!** You will find detailed nosepiece allocation tables on page 130.

# HYDRO-PNEUMATIC BLIND RIVET SETTING TOOLS

## TAURUS® 1-4 Axial

			
1 •	T1	143 4976	Nosepiece 17/18
		143 4994	Nosepiece 17/20
		143 5018	Nosepiece 17/22
	T2	143 4955	Nosepiece 17/24
		143 4973	Nosepiece 17/27
		143 4974	Nosepiece 17/29
		143 4975	Nosepiece 17/32
	T3	143 4977	Nosepiece 17/36
		143 4999	Nosepiece 17/40
		143 4860	Nosepiece 17/45
2		143 6003	Steel head sleeve 4
3 •		144 6012	O-ring
4 •		143 6002	Jaw housing
5 •		143 5568	Jaw (3-part)
6 •	T1	143 5507	Jaw pusher 1
	T2	143 5768	Jaw pusher 2
	T3, T4	143 6000	Jaw pusher 4
7		143 5999	Damping ring 4
8	T1	143 5509	Centre part 1
	T2	143 5769	Centre part 2
	T3, T4	143 6001	Centre part 4
9 •		146 3064	Spring
10		143 5863	Adapter, ext. 150mm
11	T1	143 5867	Adapter 1, ext. 150mm
	T2	143 5862	Adapter 1, ext. 150mm
	T3, T4	143 5868	Adapter 1, ext. 150mm
12		143 5856	Adapter
13		143 6915	Grip Axial complete
14		143 6481	Trip valve
15		143 5857	Spacer
16	T1	143 5558	Nozzle tube 1
	T2	143 5764	Nozzle tube 2, long
	T3, T4	143 5886	Nozzle tube 3, long
17	T1	143 6479	Tool head 1, assembled
	T2, T3	143 6476	Tool head 2, assembled
	T4	143 6422	Tool head 4, assembled
18		144 6013	Oil screw plug
19		143 5612	Sealing ring M4
20		145 2756	Stud bolt
21		145 2755	Screw connection
22 •		143 5629	O-ring
23		143 5681	Seal holder, complete
24 •		143 4227	O-ring
25 •		143 5630	Rod seal
26		143 5631	Draw bar
27 •		143 5632	Piston seal
28 •		143 5488	Supporting ring
29 •		143 5485	Piston seal
30 •		143 5671	O-ring
31		145 7746	Resetting piston, complete
32 •		143 5633	Piston seal
33 •		143 5635	Rod seal
34	T1	143 5852	Connecting piece 1
	T2, T3, T4	143 5765	Connecting piece 2/3
35		143 5519	O-ring
36		144 6167	Snap ring
37		143 5524	O-ring
38		143 5532	End cap
39		143 5663	Adapter
40		143 5842	Lock washer
41		143 5848	Screw connection
42		143 5767	Hose
43		144 5647	Protective hose
44		143 5579	Foamed material tubes (0,1m)
45 •		143 5472	Flat gasket 1
46		143 6480	Grip FA, complete
47		144 6230	Screw connection
48		144 6134	Tube 0,1m*

			
49		143 5642	Slider
50		143 5686	Orifice
51 •		143 5480	Flat gasket 2
52	T4	143 5998	Grip extension
53	T1	145 0882	Air cylinder 1 Axial
	T2	145 0941	Air cylinder 2 Axial
	T3	145 0968	Air cylinder 3 Axial
	T4	145 0994	Air cylinder 4 Axial
54		145 7750	Pressure relief valve, complete
55		143 5484	O-ring
56	T1	151 5051	Silencer 1, complete
	T2	145 7862	Silencer 2, complete
	T3, T4	145 7956	Silencer 3, complete
57		143 5667	Connecting nipple
58		144 6030	Sealing ring
59		143 5648	Spacer cage
60 •		143 5647	Rod seal
61		143 5651	Control piston
62 •		143 5675	Piston seal
63		143 5652	Piston housing
64		143 5688	O-ring
65	T1	144 6026	Stopper 1
	T2	144 6073	Stopper 2
	T3, T4	144 6100	Stopper 3
66		144 5773	HousingsScrew, short
67		143 5486	O-ring
68		143 5492	Al nut
69 •	T1	143 5658	Piston seal
	T2, T3	143 5841	Piston seal
	T4	143 6007	Piston seal
70 •	T1	143 5657	Guide ring 1
	T2, T3	143 5825	Guide ring 2
	T4	143 6006	Guide ring 3
71 •	T1	143 5656	Piston seal
	T2, T3	143 5670	Piston seal
72	T1	145 7751	Air piston 1, complete
	T2	145 7860	Air piston 2, complete
	T3	145 7952	Air piston 3, complete
	T4	145 7994	Air piston 4, complete
73 •	T1	143 5660	O-ring
	T2	143 5834	O-ring
	T3, T4	143 5937	O-ring
74 •	T1	143 5659	Rod seal
75	T1	144 6027	Snap ring
	T2, T3, T4	144 6082	V-profile ring
76	T1	143 5680	O-ring
	T2	143 5839	O-ring
	T3, T4	143 5927	O-ring
	T1	145 7752	Cylinder 1, complete
77	T2	145 7861	Cylinder 2, complete
	T3	145 7953	Cylinder 3, complete
	T4	145 7995	Cylinder 4, complete
	T1	143 5508	Bottom 1
78	T2	143 5761	Bottom 2
	T3, T4	143 5874	Bottom 3
		143 5538	Holder
80		144 5630	Allen screw
81		145 0895	Holder
82		145 2757	Allen screw
83		143 3954	Cylinder pin
84		143 5836	Hanger
85		144 6092	Hexagon head screw
86		144 5262	Nut
87		144 5342	Screw
		144 5294	Hydraulic oil refill bottle, 100 ml

• Wearing parts

\* The length required must always be specified on the order; the article numbers always refers to the price per metre.

# HYDRO-PNEUMATIC BLIND RIVET SETTING TOOLS

## TAUREX 1-4 Axial

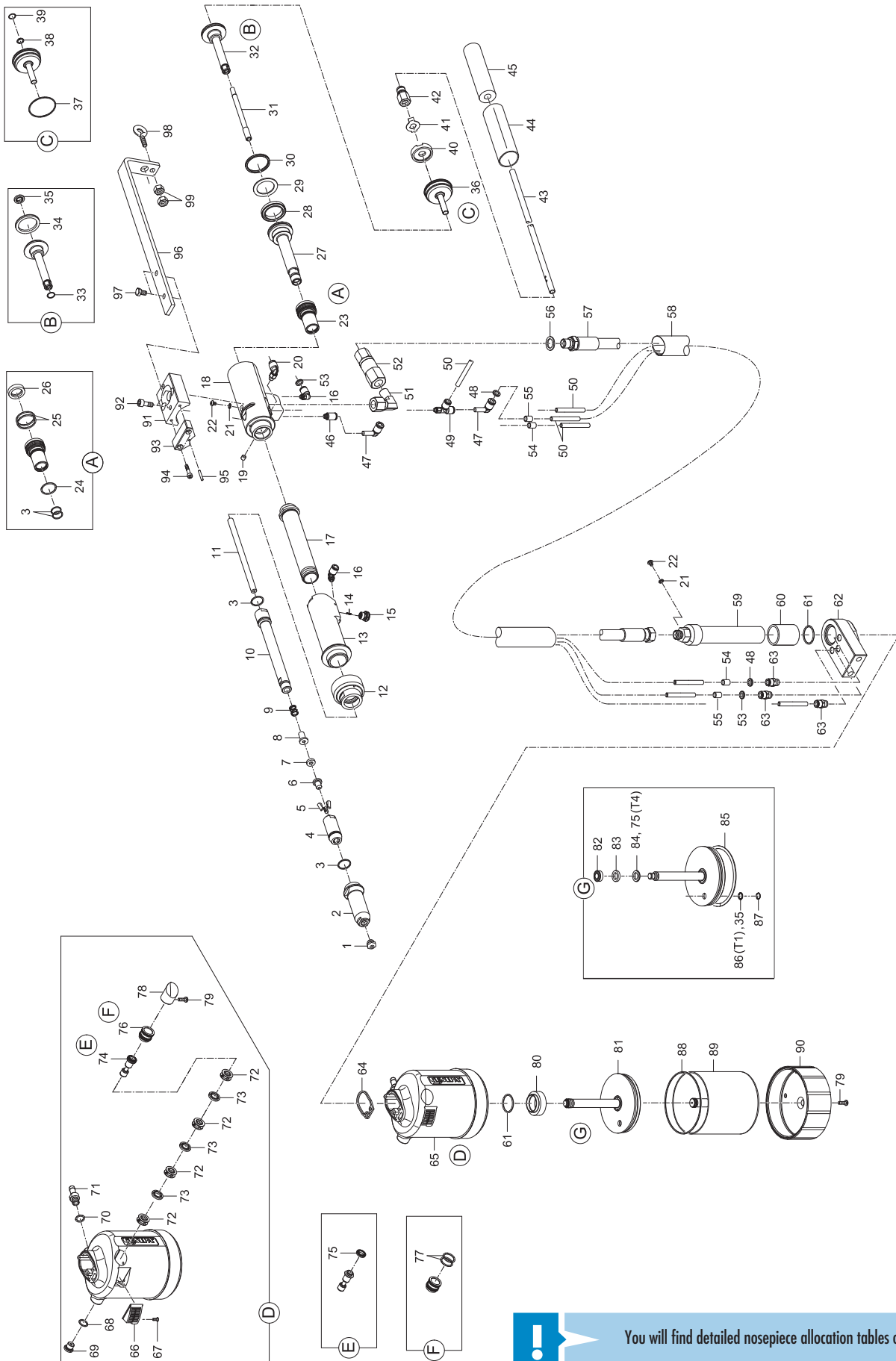

 You will find detailed nosepiece allocation tables on page 130.



# HYDRO-PNEUMATIC BLIND RIVET SETTING TOOLS

## TAUREX 1-4 Axial

📍	🔧	No.	🔗
1	T1	143 4976	Nosepiece 17/18
		143 4994	Nosepiece 17/20
		143 5018	Nosepiece 17/22
	T2	143 4955	Nosepiece 17/24
		143 4973	Nosepiece 17/27
		143 4974	Nosepiece 17/29
		143 4975	Nosepiece 17/32
	T3, T4	143 4977	Nosepiece 17/36
		143 4999	Nosepiece 17/40
		143 4860	Nosepiece 17/45
2		143 6003	Steel head sleeve 4
3 •		144 6012	O-ring
4 •		143 6002	Jaw housing 4
5 •		143 5568	Jaws (3-part)
6 •	T1	143 5507	Jaw Pusher 1
	T2	143 5768	Jaw Pusher 2
	T3, T4	143 6000	Jaw Pusher 4
7		143 5999	Damping ring 4
8	T1	143 5509	Centre part 1
	T2	143 5769	Centre part 2
	T3, T4	143 6001	Centre part 4
9		146 3064	Spring
10		143 5863	Adapter
11	T1	143 5867	Adapter 1
	T2	143 5862	Adapter 2
	T3, T4	143 5868	Adapter 3
12		143 5856	Adapter
13		143 6915	Grip Axial, complete
14		144 5996	Spring
15		143 6481	Release valve, complete
16		144 6230	Screw connection
17		143 5857	Spacer
18		145 0948	Tool head, assembled
19		145 2756	Stud bolt
20		144 6017	Angle screw connection
21		143 5612	Sealing ring M4
22		144 6013	Oil screw plug
23		143 5681	Seal holder, complete
24 •		143 5629	O-ring
25 •		143 4227	O-ring
26 •		143 5630	Rod seal
27		143 5631	Draw bar
28 •		143 5632	Piston seal
29 •		143 5488	Supporting ring
30 •		143 5485	Piston seal
31	T1	143 5558	Nozzle tube 1
	T2	143 5764	Nozzle tube 2, long
	T3, T4	143 5886	Nozzle tube 3, long
32		145 7746	Resetting piston, complete
33 •		143 5671	O-ring
34 •		143 5633	Piston seal
35 •		143 5635	Rod seal
36	T1	143 5532	End cap
	T2, T3, T4	145 7840	End cap
37		143 5524	O-ring
38		143 5519	O-ring
39		144 6167	Snap ring
40		143 5853	Supporting ring
41		143 5842	Lock washer
42		143 5848	Screw connection
43		143 5767	Hose
44		143 5579	Foamed material tubes
45		144 5647	Protective hose
46		144 6095	Screw connection
47		145 2759	Plug-in coupling
48		144 6133	Coding ring, red
49		144 6093	Screw connection
50		144 6134	PU tube*

• Wearing parts

\* The length required must always be specified on the order; the article numbers always refers to the price per metre.

📍	🔧	No.	🔗
51		144 6145	Angle screw connection
52		144 6146	Swivel
53		144 6132	Coding ring, green
54		144 5395	PA tube red*
55		144 5393	PA tube green*
56		144 6131	Sealing ring
57		144 6136	Hydraulic hose
58		144 6135	Protective hose
59	T1	151 3245	Hose connector
	T2, T3	151 3246	Hose connector
	T4	151 3247	Hose connector
60	T1, T2, T3	143 6093	Spacer tube
	T4	143 6102	Spacer tube 4
61		143 5486	O-ring
62		143 6092	Cylinder adapter
63		144 6130	Screw connection
64 •		143 5480	Flat gasket
65	T1	148 8025	Air cylinder 1, complete
	T2	148 8026	Air cylinder 2, complete
	T3	148 8027	Air cylinder 3, complete
	T4	148 8029	Air cylinder 4, complete
66	T1	151 5051	Silencer complete
	T2	145 7862	Silencer complete
	T3, T4	145 7956	Silencer complete
67		144 6089	Screw
68		143 5484	O-ring
69		145 7750	Pressure relief valve
70		144 6030	Sealing ring
71		143 5667	Connecting nipple
72		143 5648	Spacer ring
73		143 5647	Rod seal
74		145 7694	Control piston
75 •		143 5675	Piston seal
76		145 7693	Piston housing
77 •		143 5688	O-ring
78	T1	144 6026	Stopper 1
	T2	144 6073	Stopper 2
	T3, T4	144 6100	Stopper 3
79		144 5773	Screw
80		143 5492	Alu nut
81	T1	145 7751	Air piston 1 complete
	T2	145 7860	Air piston 2 complete
	T3	145 7952	Air piston 3 complete
	T4	145 7994	Air piston 4 complete
82 •	T1	143 5658	Piston seal
	T2, T3	143 5841	Piston seal
	T4	143 6007	Piston seal
83 •	T1	143 5657	Guide ring 1
	T2, T3	143 5825	Guide ring 2
	T4	143 6006	Guide ring 4
84 •	T1	143 5656	Piston seal
	T2, T3	143 5670	Piston seal
85 •	T1	143 5660	O-ring
	T2	143 5834	O-ring
	T3, T4	143 5937	O-ring
86 •	T1	143 5659	Rod seal
	T1	144 6027	Snap ring
87		144 6082	Snap ring
88	T1	143 5680	O-ring
	T2	143 5839	O-ring
	T3, T4	143 5927	O-ring
	T1	145 7752	Cylinder 1 complete
89	T2	145 7861	Cylinder 2 complete
	T3	145 7953	Cylinder 3 complete
	T4	145 7995	Cylinder 4 complete
	T1	143 5508	Bottom 1
90	T2	143 5761	Bottom 2
	T3, T4	143 5874	Bottom 3
	T1	143 5538	Holder
92		144 5630	Allen screw
93		145 0895	Holder
94		143 6915	Allen screw
95		143 3954	Cylinder pin
96		143 5855	Hanger
97		144 6087	Hexagon head screw
98		144 5342	Screw
99		144 5262	Nut
		144 5294	Hydraulic oil refill bottle 100ml

# HYDRO-PNEUMATIC BLIND RIVET SETTING TOOLS

## Spring-loaded trigger system for TAURUS® 1-4 Axial eco

Location	Tool	No.	Description
1 •	T1	143 5591	Nosepiece 17/18 AV
		143 4990	Nosepiece 17/20 AV
		143 4991	Nosepiece 17/22 AV
	T2	143 5592	Nosepiece 17/24 AV
		143 5593	Nosepiece 17/27 AV
		143 5594	Nosepiece 17/29 AV
		143 5595	Nosepiece 17/32 AV
		143 5596	Nosepiece 17/36 AV
	T3, T4	143 5597	Nosepiece 17/40 AV
		143 5598	Nosepiece 17/45 AV
143 5466		Steel head sleeve	
2	T1	145 0887	Support sleeve AV, complete
	T2	145 0943	Support sleeve AV, complete
	T3, T4	145 0978	Support sleeve AV, complete
3		143 5499	Union nut
4		144 6012	O-ring
5 •		143 6002	Jaw housing 4
6 •		143 5568	Jaws (3-part)
7 •	T1	143 5507	Jaw pusher 1
	T2	143 5768	Jaw pusher 2
	T3, T4	143 6000	Jaw pusher 4

Location	Tool	No.	Description
9		143 5999	Damping ring 4
10	T1	143 5509	Centre part 1
	T2	143 5769	Centre part 2
	T3, T4	143 6001	Centre part 4
11 •		146 3064	Spring
12 •		144 5994	Spring
13		144 5995	Allen screw
14		152 4521	Stamp
15		143 5498	Casing
16		143 5529	O-ring
17		144 6010	Snap ring
18 •	T1	143 5599	Nosepiece Ø 2,5
	T2	143 5600	Nosepiece Ø 3,2
	T3, T4	143 5601	Nosepiece Ø 4,5
19		143 5467	Support sleeve

• Wearing parts

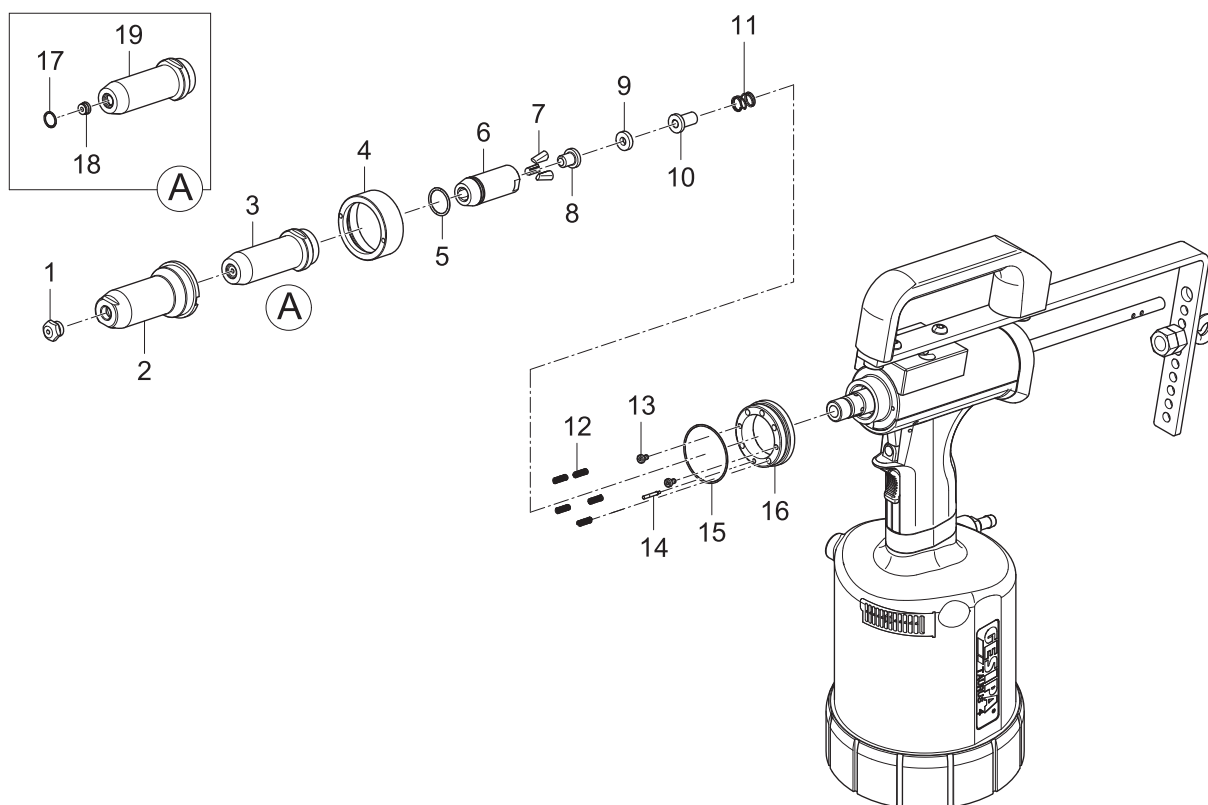

# HYDRO-PNEUMATIC BLIND RIVET SETTING TOOLS

## Spring-loaded trigger system for TAURUS® 1-4 Axial

📍	🔧	No.	🔗
1 •	T1	143 5591	Nosepiece 17/18 AV
		143 4990	Nosepiece 17/20 AV
		143 4991	Nosepiece 17/22 AV
	T2	143 5592	Nosepiece 17/24 AV
		143 5593	Nosepiece 17/27 AV
		143 5594	Nosepiece 17/29 AV
		143 5595	Nosepiece 17/32 AV
		143 5596	Nosepiece 17/36 AV
	T3, T4	143 5597	Nosepiece 17/40 AV
		143 5598	Nosepiece 17/45 AV
143 5466		Steel head sleeve	
2		143 5466	Steel head sleeve
3	T1	145 0887	Support sleeve AV, complete
	T2	145 0943	Support sleeve AV, complete
	T3, T4	145 0978	Support sleeve AV, complete
4		143 5499	Union nut
5 •		144 6012	O-ring
6 •		143 6002	Jaw housing 4
7 •		143 5568	Jaws (3-part)
8 •	T1	143 5507	Jaw pusher 1
	T2	143 5768	Jaw pusher 2
	T3, T4	143 6000	Jaw pusher 4

📍	🔧	No.	🔗
9		143 5999	Damping ring 4
10	T1	143 5509	Centre part 1
	T2	143 5769	Centre part 2
	T3, T4	143 6001	Centre part 4
11 •		146 3064	Spring
12	T1	143 5867	Adapter 1
	T2	143 5862	Adapter 2
	T3, T4	143 5868	Adapter 3
13		143 5863	Adapter, ext. 150mm
14		144 6097	Allen screw
15 •		144 5994	Spring
16		145 0947	Valve body, complete
17		143 5866	Rod seal
18		144 6010	Snap ring
19 •	T1	143 5599	Nosepiece Ø 2,5
	T2	143 5600	Nosepiece Ø 3,2
	T3, T4	143 5601	Nosepiece Ø 4,5
20		143 5467	Support sleeve

• Wearing parts

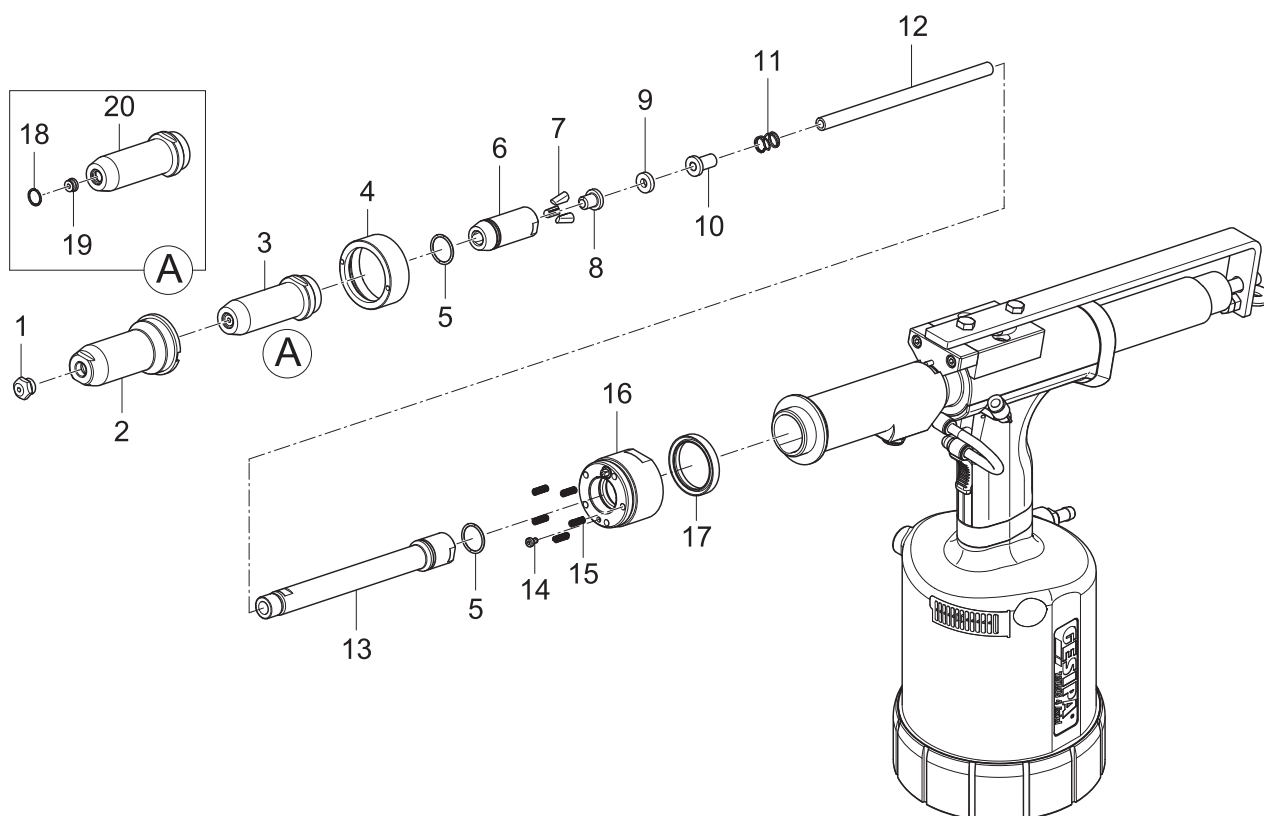

# HYDRO-PNEUMATIC BLIND RIVET SETTING TOOLS

## TAURUS® 1 Speed Rivet / TAURUS® 2 Speed Rivet

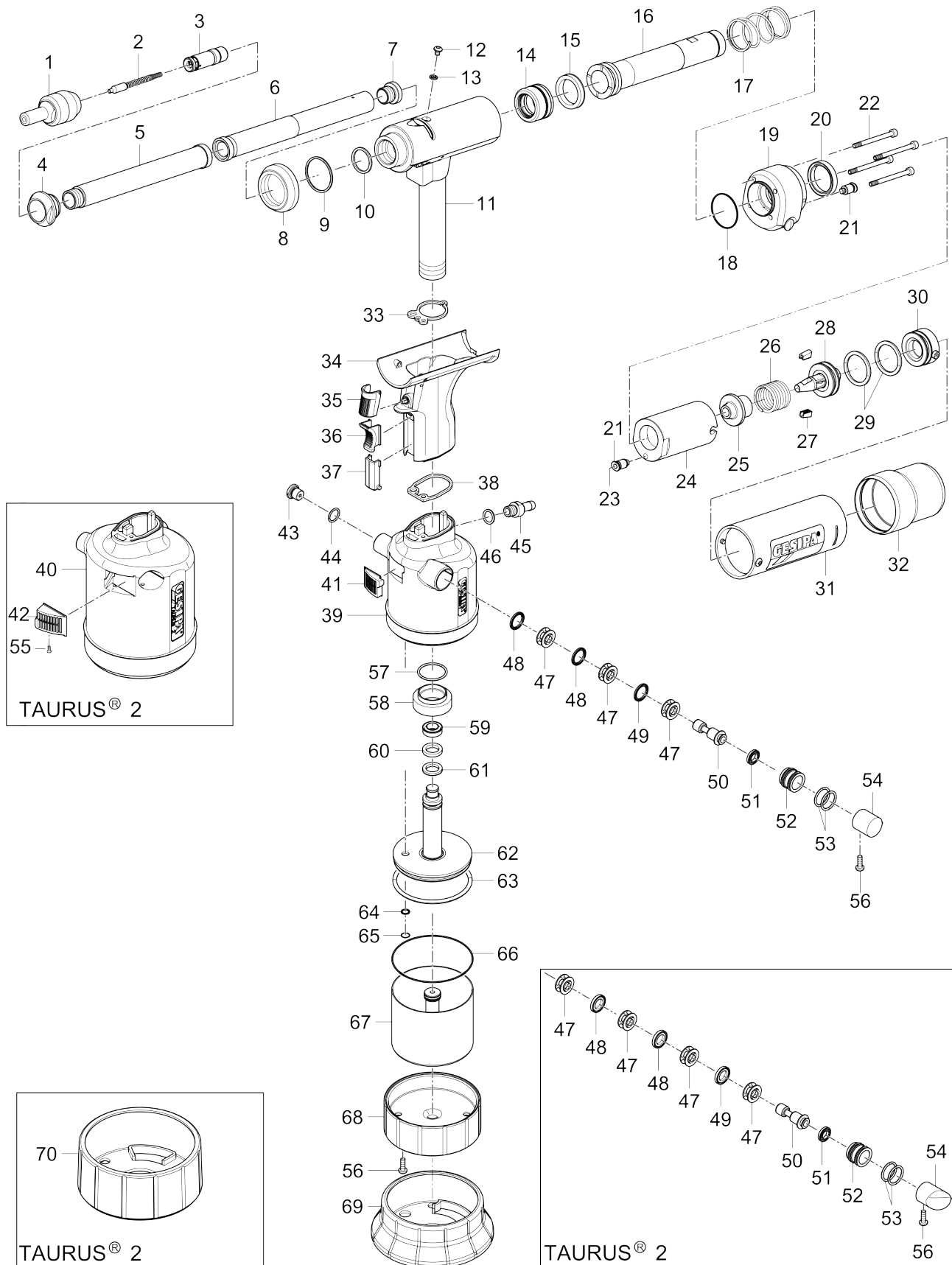

# HYDRO-PNEUMATIC BLIND RIVET SETTING TOOLS

## TAURUS® 1 Speed Rivet / TAURUS® 2 Speed Rivet

		No.	
1 •		145 7753	Spreader nosepiece 3.2, complete
		145 7754	Spreader nosepiece 4.0 complete
		145 7755	Spreader nosepiece 4.8 complete
		145 7756	Spreader nosepiece 3.2 extended, complete
		145 7757	Spreader nosepiece 4.0 extended, complete
		145 7758	Spreader nosepiece 4.8 extended, complete
		145 0906	Spreader nosepiece 3.2 with opening mechanism complete
		145 0907	Spreader nosepiece 4.0 with opening mechanism complete
		145 0908	Spreader nosepiece 4.8 with opening mechanism complete
		145 0909	Spreader nosepiece 3.2 extended with opening mechanism, complete
		145 0910	Spreader nosepiece 4.0 extended with opening mechanism complete
		145 0911	Spreader nosepiece 4.8 extended with opening mechanism, complete
2 •		145 7759	Spring 3.2, complete
		145 7761	Spring 4.0 complete
		145 7763	Spring 4.8 complete
		145 7760	Spring 3.2 extended, complete
		145 7762	Spring 4.0 extended, complete
		145 7764	Spring 4.8 extended, complete
3 •		145 0918	Slide lock, complete
4		143 5705	Locator for guide tube SR
5 •		143 5710	Guide tube 2 SR
6 •		143 5709	Guide tube 1 SR
7		143 5712	End screw SR
8		143 5952	Ring
9		143 4266	O-ring
10		143 4462	O-ring
11	<b>T1</b>	145 0919	Tool head 1 SR, assembled
	<b>T2</b>	145 0937	Tool head 2 SR, assembled
12		144 6013	Oil screw plug
13		143 5612	Sealing ring M4
14 •		145 7765	Oil piston, complete
15 •		143 5723	Piston seal
16		143 5722	Pull tube SR
17		143 5721	Spring
18		144 6053	O-ring
19		146 4433	Connection block
20 •		144 6051	Rod seal
21		144 6049	Screw connection
22		144 5970	Allen screw
23		144 6045	Compressed air hose
24		143 5702	Clamp housing
25		143 5704	Pressure sleeve
26		143 5699	Compression spring
27 •		143 5701	Jaw
28		145 7766	Jaw guide, complete
29 •		144 6052	O-ring
30		145 0920	Cover, complete
31		145 0921	Protective tube, complete
32		143 5714	Protective cap

		No.	
33 •		143 5472	Flat gasket 1
34		145 0922	Grip, complete
35		144 6025	Activation button
36		143 5642	Slider
37		143 6169	Orifice
38 •		143 5480	Flat gasket 2
39	<b>T1</b>	145 0923	Air cylinder SR 1, complete
40	<b>T2</b>	145 0938	Air cylinder SR 2, complete
41	<b>T1</b>	151 5051	Silencer 1
42	<b>T2</b>	144 6088	Silencer 2
43		145 7750	Pressure relief valve, complete
44		143 5484	O-ring
45		143 5667	Connecting nipple
46		144 6030	Sealing ring
47		143 5648	Spacer cage
48		143 5647	Rod seal
49		143 6248	Washer
50		143 6187	Rod seal
51 •		143 5675	Piston seal
52		143 5652	Piston housing
53		143 5688	O-ring
54	<b>T1</b>	144 6026	Stopper 1
	<b>T2</b>	144 6073	Stopper 2
55		144 6089	Screw
56		144 5773	Housing screw short
57		143 5486	O-ring
58		143 5492	Al nut
59 •	<b>T1</b>	143 5658	Piston seal
	<b>T2</b>	143 5841	Piston seal
60 •	<b>T1</b>	143 5657	Guide ring 1
	<b>T2</b>	143 5825	Guide ring 2
61 •	<b>T1</b>	143 5656	Piston seal
	<b>T2</b>	143 5670	Piston seal
62	<b>T1</b>	145 7751	Air piston 1, complete
	<b>T2</b>	145 7860	Air piston 2, complete
63 •	<b>T1</b>	143 5660	O-ring
	<b>T2</b>	143 5834	O-ring
64 •	<b>T1</b>	143 5659	Rod seal
	<b>T2</b>	143 5635	Rod seal
65	<b>T1</b>	144 6027	Snap ring
	<b>T2</b>	144 6082	V-profile ring
66	<b>T1</b>	143 5680	O-ring
	<b>T2</b>	143 5839	O-ring
67	<b>T1</b>	145 7752	Cylinder 1, complete
	<b>T2</b>	145 7861	Cylinder 2, complete
68	<b>T1</b>	143 5508	Bottom 1
	<b>T2</b>	143 5761	Bottom 2
69	<b>T1</b>	143 6394	Rubber foot 1
70	<b>T2</b>	143 6371	Rubber foot 2
		144 5294	Hydraulic oil refill bottle, 100 ml

• Wearing parts

You will find detailed nosepiece allocation tables on page 130.

# HYDRO-PNEUMATIC BLIND RIVET SETTING TOOLS



## **TAURUS® 1 Speed Rivet Axial eco**

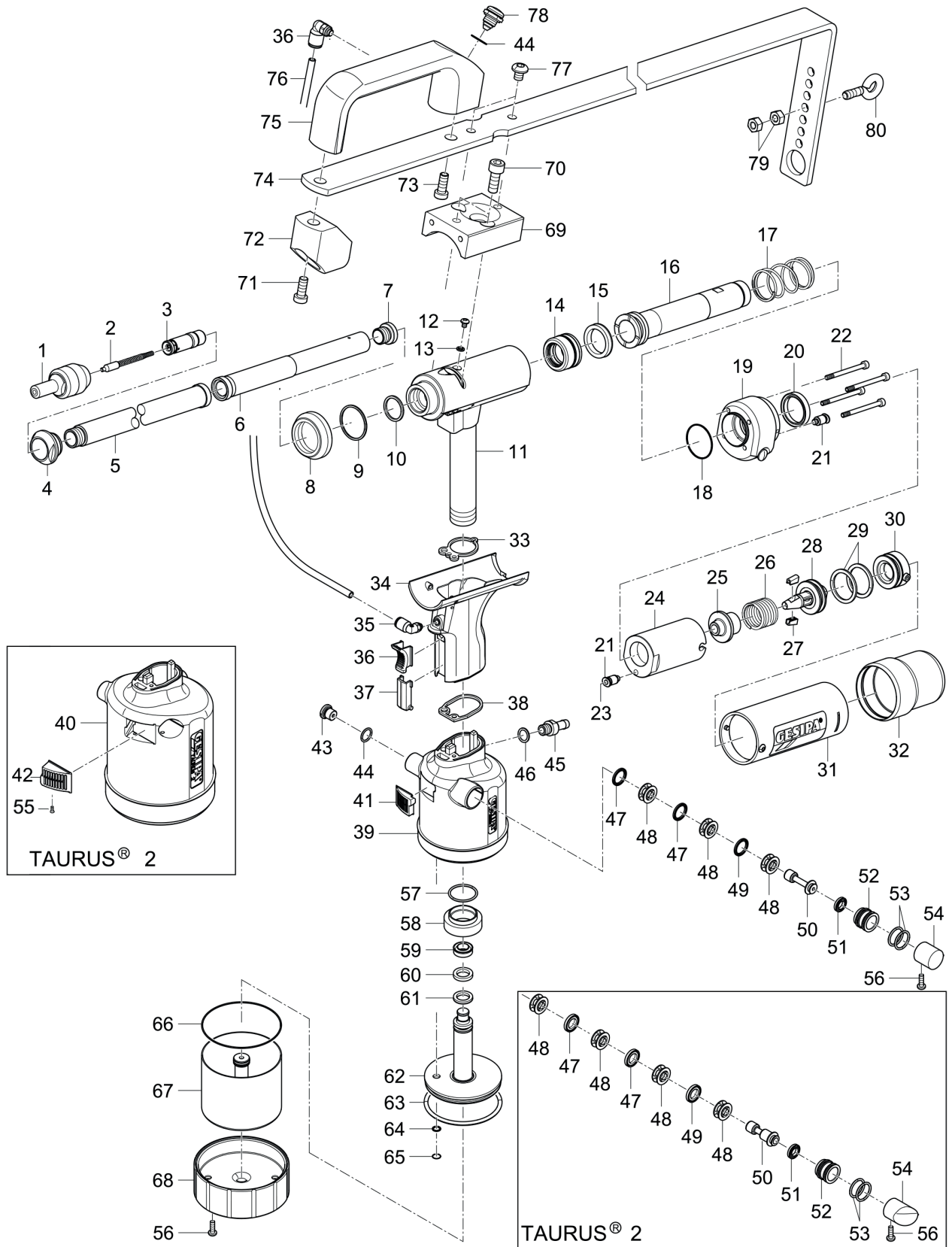

## **TAURUS® 2 Speed Rivet Axial eco**



# HYDRO-PNEUMATIC BLIND RIVET SETTING TOOLS

## TAURUS® 1 Speed Rivet Axial eco TAURUS® 2 Speed Rivet Axial eco

		No.	
1 •		145 7753	Spreader nosepiece 3.2. complete
		145 7754	Spreader nosepiece 4.0. complete
		145 7755	Spreader nosepiece 4.8. complete
		145 7756	Spreader nosepiece 3.2. extended complete
		145 7757	Spreader nosepiece 4.0 extended complete
		145 7758	Spreader nosepiece 4.8 extended complete
		145 0906	Spreader nosepiece 3.2 with opening mechanism complete
		145 0907	Spreader nosepiece 4.0 with opening mechanism complete
		145 0908	Spreader nosepiece 4.8 with opening mechanism complete
		145 0909	Spreader nosepiece 3.2 extended with opening mechanism, complete
		145 0910	Spreader nosepiece 4.0 extended with opening mechanism, complete
	145 0911	Spreader nosepiece 4.8 extended with opening mechanism, complete	
2 •		145 7759	Spring 3.2, complete
		145 7761	Spring 4.0, complete
		145 7763	Spring 4.8, complete
		145 7760	Spring 3.2 extended, complete
		145 7762	Spring 4.0 extended, complete
		145 7764	Spring 4.8 extended, complete
3 •		145 0918	Slide lock, complete
4		143 5705	Locator for guide tube SR
5 •		143 5710	Guide tube 2 SR
		143 5685	Guide tube long 2 SR
6 •		143 5709	Guide tube 1 SR
7		143 5712	End screw SR
8		143 5952	Ring
9		143 4266	O-ring
10		143 4462	O-ring
11	<b>T1</b>	145 0924	Tool head, assembled 1 SR
	<b>T2</b>	145 0940	Tool head, assembled 2 SR
12		144 6013	Oil screw plug
13		143 5612	Sealing ring M4
14 •		145 7765	Oil piston, complete
15 •		143 5723	Piston seal
16		143 5722	Pull tube SR
17		143 5721	Spring
18		144 6053	O-ring
19		146 4433	Connection block
20 •		144 6051	Rod seal
21		144 6049	Screw connection
22		144 5970	Allen screw
23		144 6045	Tube
24		143 5702	Clamp housing
25		143 5704	Pressure sleeve
26		143 5699	Compression spring
27		143 5701	Jaw
28		145 7766	Jaw guide, complete
29 •		144 6052	O-ring
30		145 0920	Cover, complete
31		145 0921	Protective tube, complete
32		143 5714	Protective cap
33 •		143 5472	Flat gasket 1
34		145 0925	Grip, complete
35		144 6230	Hose connector
36		143 5642	Slider
37		143 6169	Orifice
38 •		143 5480	Flat gasket 2

		No.	
39	<b>T1</b>	145 0923	Air cylinder SR 1, complete
40	<b>T2</b>	145 0938	Air cylinder SR 2, complete
41	<b>T1</b>	151 5051	Silencer 1
42	<b>T2</b>	144 6088	Silencer 2
43		145 7750	Pressure relief valve, complete
44		143 5484	O-ring
45		143 5667	Connecting nipple
46		144 6030	Sealing ring
47		143 5648	Spacer cage
48		143 5647	Rod seal
49		143 6248	Washer
50		143 6187	Rod seal
51 •		143 5675	Piston seal
52		143 5652	Piston housing
53		143 5688	O-ring
54		144 6026	Stopper 1
		144 6073	Stopper 2
56		144 6089	Screw
57		144 5773	Housing screw, short
58		143 5486	O-ring
59		143 5492	Al nut
60 •	<b>T1</b>	143 5658	Piston seal
	<b>T2</b>	143 5841	Piston seal
61 •	<b>T1</b>	143 5657	Guide ring 1
	<b>T2</b>	143 5825	Guide ring 2
62 •	<b>T1</b>	143 5656	Piston seal
	<b>T2</b>	143 5670	Piston seal
63	<b>T1</b>	145 7751	Air piston 1, complete
	<b>T2</b>	145 7860	Air piston 2, complete
64 •	<b>T1</b>	143 5660	O-ring
	<b>T2</b>	143 5834	O-ring
65 •	<b>T1</b>	143 5659	Rod seal
	<b>T2</b>	143 5635	Rod seal
66	<b>T1</b>	144 6027	Snap ring
	<b>T2</b>	144 6082	V-ring
67	<b>T1</b>	143 5680	O-ring
	<b>T2</b>	143 5839	O-ring
68	<b>T1</b>	145 7752	Cylinder 1, complete
	<b>T2</b>	145 7861	Cylinder 2, complete
69	<b>T1</b>	143 5508	Bottom 1
	<b>T2</b>	143 5761	Bottom 2
70		143 5538	Holder
71		144 5630	Allen screw
72		144 6085	Allen screw
73		143 5684	Holder
74		144 6042	Allen screw
75		143 5682	Hanger
		143 5683	Hanger long
76		143 5575	Grip
77		144 6134	Hose
78		144 6087	Fillister head screw
79		145 6753	Valve complete
80		144 5262	Nut
81		144 5342	Screw
		144 5294	Hydraulic oil refill bottle, 100 ml

• Wearing parts

\* The length required must always be specified on the order; the article numbers always refers to the price per metre.



You will find detailed nosepiece allocation tables on page 130.

# HYDRO-PNEUMATIC BLIND RIVET SETTING TOOLS

## PH 1 and PH 2

📍	🔧	No.	🔗
1 •	PH 1	143 4285	Nosepiece 16/18
	PH 1, PH 2	143 4288	Nosepiece 16/24
	PH 1, PH 2	143 4289	Nosepiece 16/27
	PH 1, PH 2	143 4290	Nosepiece 16/29
	PH 2	143 4291	Nosepiece 16/32
2		143 4105	Steel head sleeve
3 •	PH 1	143 4243	Jaw housing
	PH 2	143 4102	Jaw housing
4 •	PH 1	143 4071	Jaws (2-part)
	PH 1	143 4241	Jaws (2-part) per pair with fine tothing for blind rivets with small nominal Ø (2.4; 3 and 3.2 all materials)
5 •	PH 2	143 4103	Jaws (3-part)
	PH 1	143 4242	Jaw pusher
6 •	PH 2	143 4319	Jaw pusher
		144 5314	Compression spring
7		143 4320	Jaw adapter
8		143 4321	Nut
9 •		143 4318	Piston guide with wiper
10 •		143 4323	K seal
11		143 4315	Tool head
12		144 5305	Snap ring
13 •		143 4324	K seal
14		143 4322	Piston
15 •		143 4326	K seal
16		143 4325	Sealing ring holder
17		145 6792	Tool head assembly (9-16)
18 •		144 5304	Return spring
19		143 4327	Closure screw
20		144 5302	Spent mandrel container
21		143 4343	Plastic grip
22		143 4337	Locking nut

📍	🔧	No.	🔗
23	PH 1	143 4244	Tool body
	PH 2	143 4328	Tool body
24	PH 1	143 4246	Buffer ring
	PH 2	143 4334	Buffer ring
25	PH 1	145 6769	Air piston, complete
	PH 2	145 6791	Air piston, complete
26 •		143 4332	Round cord packing ring
27	PH 1	143 4245	End cap complete
	PH 2	143 4331	End cap complete
28		143 4330	Release lever
29		144 5307	Grooved pin
30		144 5308	Compression spring
31		145 6785	Valve tube
32		144 5306	Valve spring
33 •		143 4329	Valve spud
34 •		144 5303	Compression spring
35		143 5258	Sealing ring
36		145 6784	Hose fitting with sealing ring
		143 5261	Jaw pusher with reducing tube for thin mandrels Ø up to 2.3 mm
		143 5262	Jaw pusher with reducing tube for thin mandrels Ø up to 2.3 mm
		145 6780	Hydraulic oil (1 bottle) 250 ml
		143 4311	Universal wrench MSU

• Wearing parts

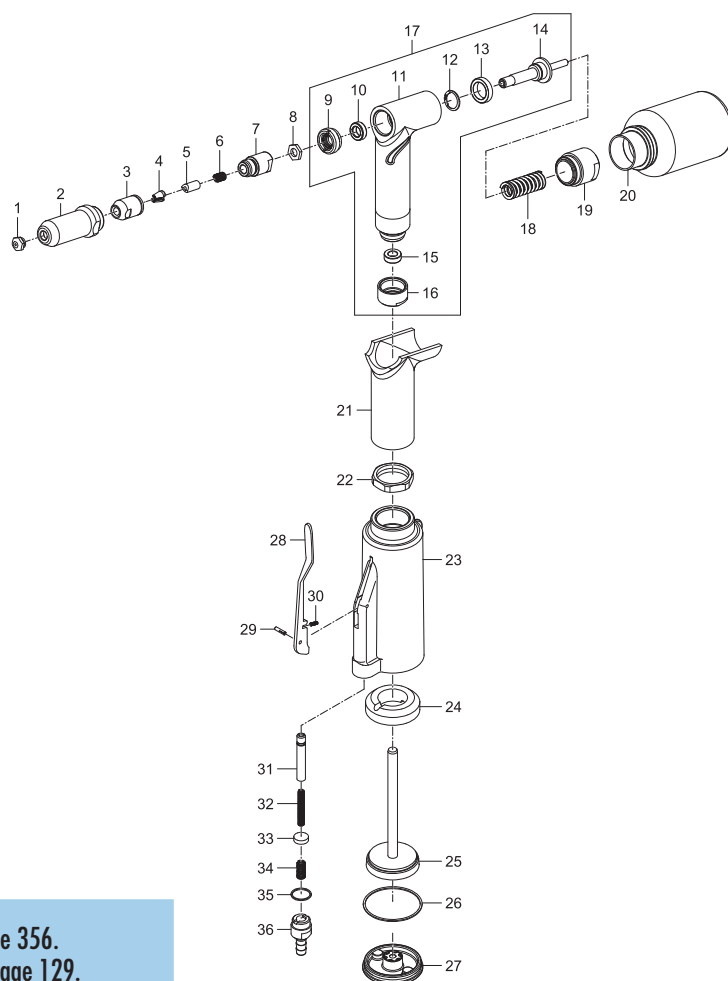

**!** You will find spare part kits for PH 1 and PH 2 on page 356.  
You will find detailed nosepiece allocation tables on page 129.



# HYDRO-PNEUMATIC BLIND RIVET SETTING TOOLS

## PH Axial

No.		
1	143 6115	Tool head
2	143 6117	Tool body
5	145 8066	Piston guide with wiper no. 69
	143 6114	Temporary attachment for part no. 5
6	143 6118	Damping ring
7	143 6119	Sealing ring mount
11	143 6123	Connection screw
12	143 6124	Guide tube
13	143 6125	Draw bar
14	143 6126	Release lever
16/24 •	143 4288	Nosepiece
16/27 •	143 4289	Nosepiece
16/29 •	143 4290	Nosepiece
16/32 •	143 4291	Nosepiece
16/36 •	143 4292	Nosepiece
20	143 4105	Head
22 •	143 4103	Jaws (3-part)
25 •	143 4319	Jaw pusher
26 •	143 4102	Jaw housing
27	143 4320	Jaw adapter
28	143 4322	Piston
29	145 6785	Valve tube
31	144 6166	Connection plug
35	144 5700	Cylinder screw (together)
36	143 5257	Valve screw
37	143 6132	Eye bolt with assembly mandrel
39	143 4321	Nut
40	144 5307	Grooved pin
42	144 6167	Snap ring
43	144 5305	Snap ring
46	144 6168	Supporting washer
47	143 6133	Compression spring
48 •	144 5304	Return spring
49	144 5306	Valve spring
50	144 5308	Compression spring

No.		
51 •	144 5314	Compression spring
54	143 6135	O-ring
55	143 6134	O-ring
56	143 6136	O-ring
58	143 4497	O-ring
59	143 6137	O-ring
60	143 6116	Rod seal
61	143 5256	O-ring
63	143 6138	O-ring
64 •	143 4323	K seal
65 •	143 4324	K seal
66 •	143 4326	K seal
69	143 6139	Wiper
70	144 6169	Sealing ring
71 •	143 4329	Valve spud
72	143 6140	USIT ring
74	145 8068	Union with O-ring no. 63
75 *	143 6141	Adapter
76 *	144 6164	Spent mandrel container
76 a	143 6142	Impact washer
77 *	144 5265	Suspension bracket
78	143 6143	Drain hose (1.5 m long)
79	144 5819	Stud bolt
80	145 8070	Air piston complete with no. 55 and 60
85	145 8071	End cap complete
90	145 8072	Screw-in nozzle, complete
95	145 8073	Hydraulic seal kit with part no. 54, 56, 58, 64, 65, 66
100	145 8074	Pneumatic seal kit for air piston no. 80 with part no. 54, 55, 60
125 •	143 6130	Jaw pusher with reducing tube for blind rivets up to 4 mm Ø and Al and Cu
	145 6780	Hydraulic oil refill bottle 250 ml



• Wearing parts

\*Special accessories

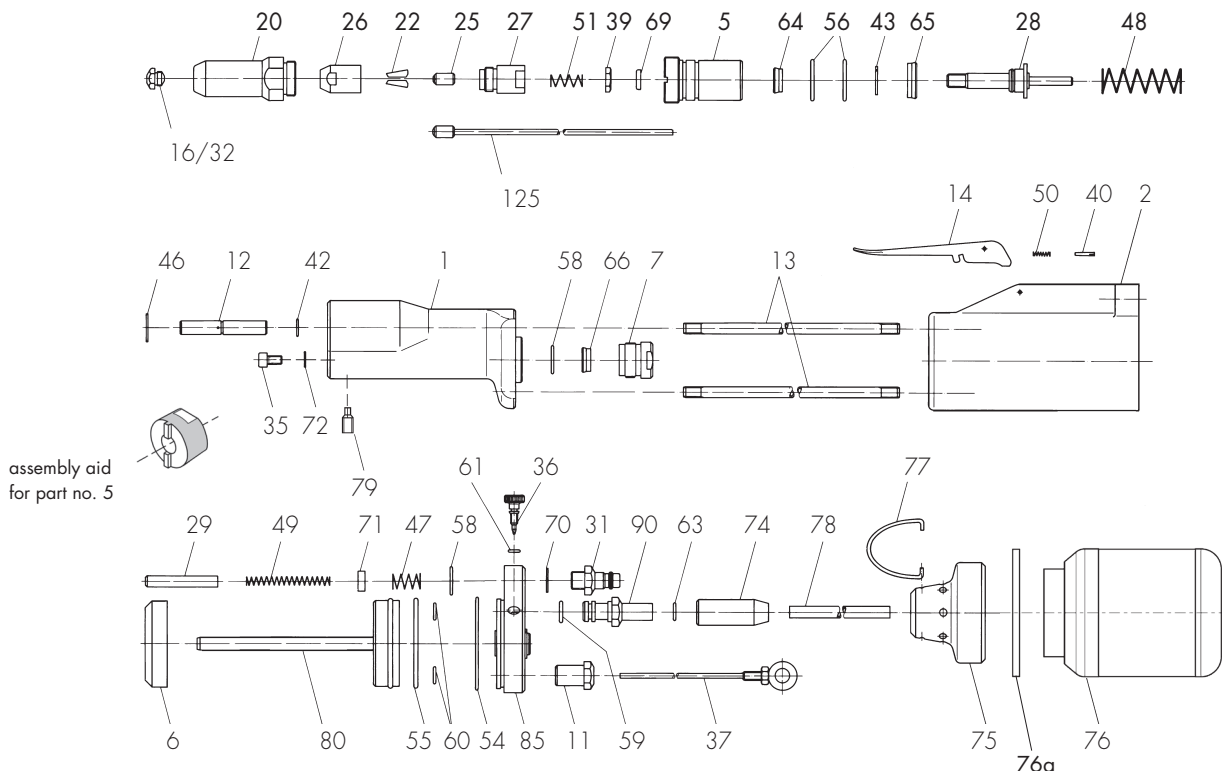
**!** You will find detailed nosepiece allocation tables on page 129.





## VAS for PH 1 and PH 2

	No.	
19-A	143 5248	Connecting nipple
21-A	143 5249	Nozzle tube
22-A •	143 5250	Plastic tube
23-A	143 5251	Connection screw complete with 24-A and 30-A
24-A •	143 5252	O-ring set
25-A	143 5253	Connection ring complete with 31-A and nipple
26-A	143 5254	Slotted nut
27-A	143 5255	Valve body with hose adapter
28-A •	143 5256	O-ring
29-A	143 5257	Valve screw
30-A •	143 5259	Scraper ring set
31-A	144 5828	Locking screw
126-A •	143 5258	Sealing ring
162-A	143 5260	Plastic grip
890	143 4233	Spent mandrel container, complete
896	144 5295	Air deflector
70	143 5261	PH 1 jaw pusher with reducing tube for thin mandrels up to 2.3 mm Ø
71	143 4270	PH 1 jaw pusher with reducing tube for thin mandrels up to 3.2 mm Ø
170	143 5262	PH 2 jaw pusher with reducing tube for thin mandrels up to 2.3 mm Ø
176	143 4311	Universal wrench MSU

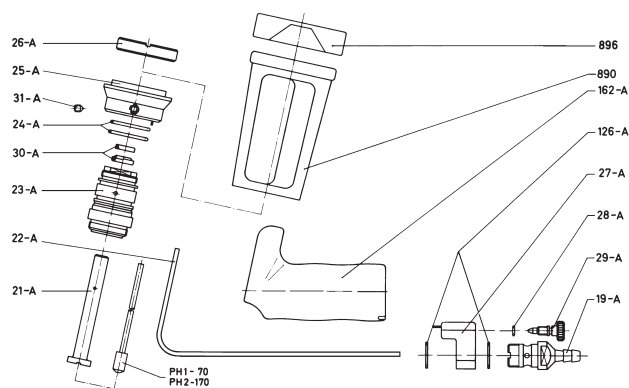
• Wearing parts





## Angle head for PH 1 and PH 2

	No.	
1	143 4031	Housing for 3-part jaws
2	143 4032	Knurled nut
3	143 4033	Locking nut
4 •	143 4034	Jaw housing for 3-part jaws
4A •	143 4037	Jaw housing for 2-part jaws
5	143 4035	Lock activator
6A •	143 4071	Jaws (2-part) per set
106 •	143 4103	Jaws (3-part) per set
7 •	144 5256	Jaw pusher for 3-part jaws
7A •	143 4038	Jaw pusher for 2-part jaws
8 •	144 5257	Compression spring
9	143 4036	Plug for 3-part jaws
9A	143 4039	Plug for 2-part jaws
16/18 •	143 4285	Nosepiece
16/24 •	143 4288	Nosepiece
16/27 •	143 4289	Nosepiece
16/29 •	143 4290	Nosepiece
16/32 •	143 4291	Nosepiece

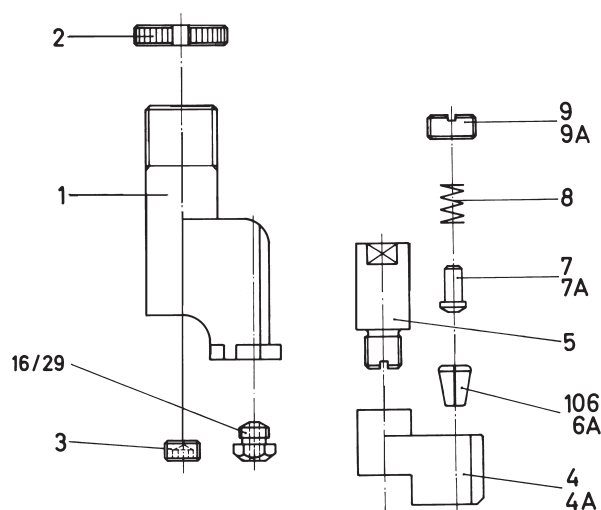
• Wearing parts



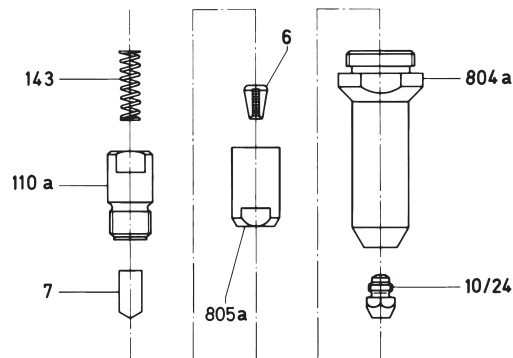

## Small jaw assembly for PH 1 and PH 2

	No.	
6 •	143 4071	Jaws (2-part) per set
7 •	143 4242	Jaw pusher
10/18 •	143 4055	Nosepiece
10/24 •	143 4061	Nosepiece
10/27 •	143 4062	Nosepiece
10/29 •	143 4064	Nosepiece
10/32 •	143 4065	Nosepiece
71	143 4270	PH 1 jaw pusher with reducing tube for 2.4 mm Ø Al and 3.2 mm Ø CAP® blind rivets
110 a	143 4345	Jaw adapter
143 •	144 5314	Compression spring
804 a	143 4346	Steel head sleeve
805 a •	143 4344	Jaw housing



• Wearing parts

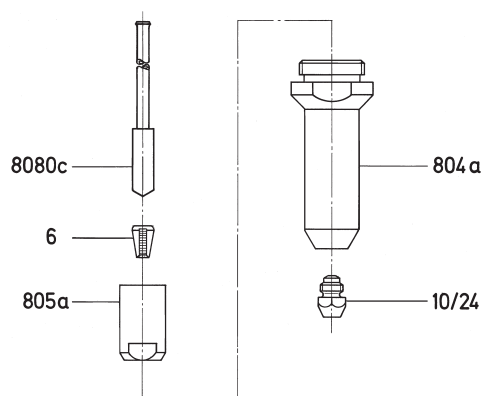

## Small jaw assembly for PH 2000

	No.	
6 •	143 4071	Jaws (2-part) per set
10/18 •	143 4055	Nosepiece
10/24 •	143 4061	Nosepiece
10/27 •	143 4062	Nosepiece
10/29 •	143 4064	Nosepiece
10/32 •	143 4065	Nosepiece
804 a	143 4346	Steel head sleeve
805 a •	143 4344	Jaw housing
8080 c •	143 4169	Jaw pusher with nozzle tube



• Wearing parts

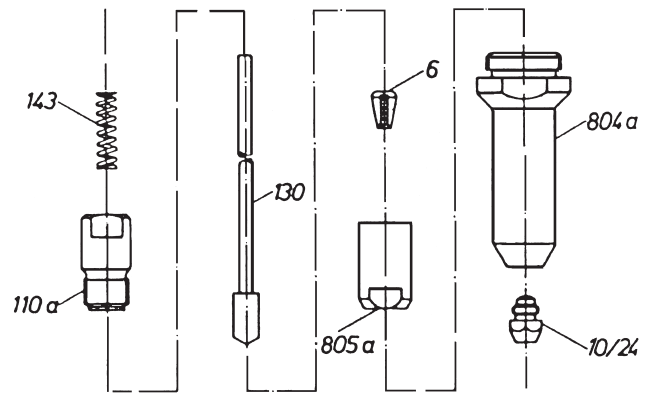

## Small jaw assembly for PH-Axial

	No.	
298	145 8075	Small jaw assembly complete with nosepiece 10/24 (optionally also with 10/18, 10/27, 10/29, 10/32)
6 •	143 4071	Jaws (2-part) per set
10/18 •	143 4055	Nosepiece
10/24 •	143 4061	Nosepiece
10/27 •	143 4062	Nosepiece
10/29 •	143 4064	Nosepiece
10/32 •	143 4065	Nosepiece
110 a	143 4345	Jaw adapter
143 •	144 5314	Compression spring
804 a	143 4346	Head
805 a •	143 4344	Jaw housing
130 •	143 6131	Jaw pusher with reducing tube for blind rivets up to 4 mm Ø and Al and Cu



• Wearing parts

## Spent mandrel container for PH-Axial

	No.	
2	143 6120	Adapter
3	143 6121	Cover
4	143 6122	Stud bolt
7	143 6127	Container
8	143 6128	Casing
10	143 6129	Ring eye M6
14	144 6165	Allen screw
	145 8065	Spent mandrel container, complete for PH-Axial

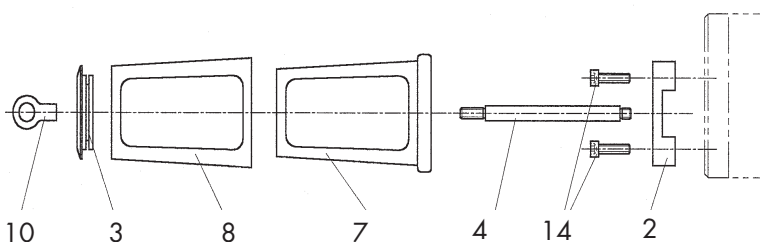

## **PH1/PH2 extension unit 100 mm**

**Two-part for PH 1 and PH 2:**

**Article no. 145 6779**

	No.	
1	143 4164	Extension sleeve
2	143 4166	Extension piece

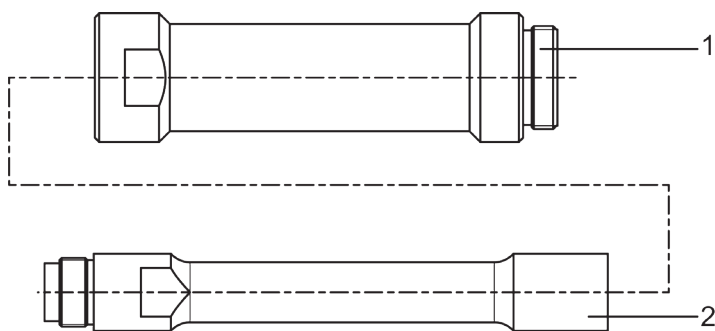

## **PH 2000 extension unit 100 mm**

**Three-part for PH 2000:**

**Article no. 145 6765**

	No.	
1	143 4164	Extension sleeve
2	143 4165	Extension piece
3	143 4170	Jaw pusher with nozzle tube

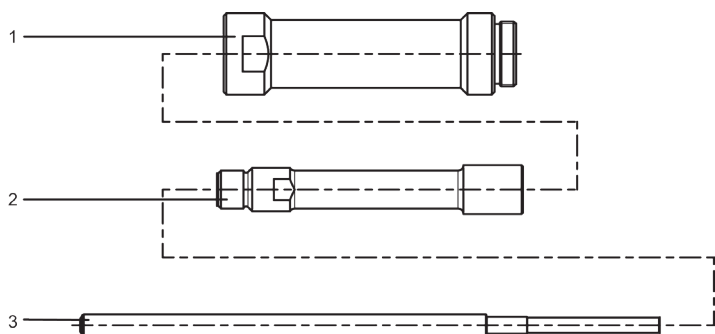

# LOCKBOLT SETTING TOOLS

## **TAURUS® 4 SRB with angle head 90°**

**for 6.4mm (1/4") C6L and Magna-Grip® lockbolts**

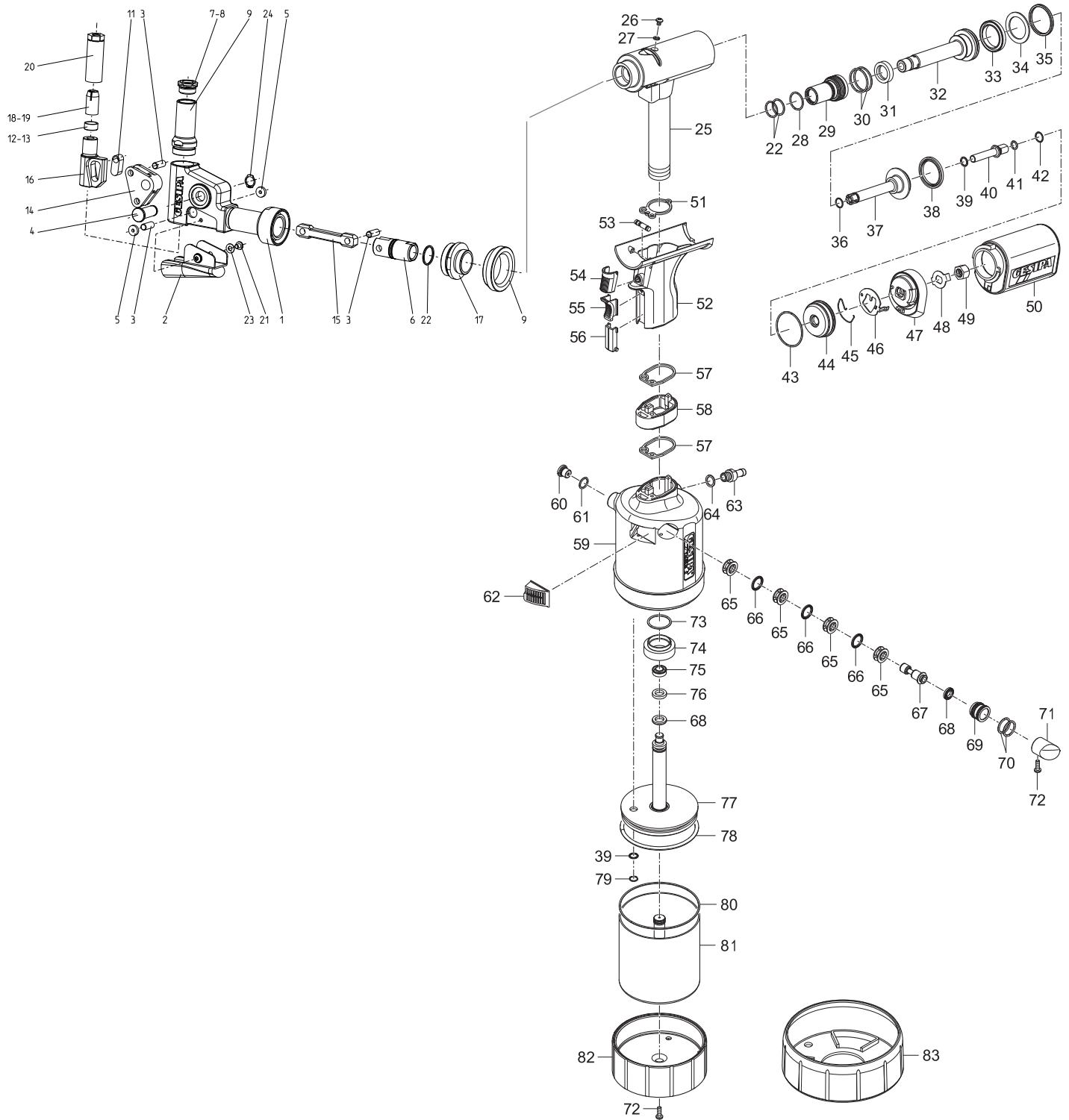



**!** The suitability of nosepiece and fastener needs to be tested by the user and is user's own responsibility!

# LOCKBOLT SETTING TOOLS

## TAURUS® 4 SRB with angle head 90°

for 6.4mm (1/4") C6L and Magna-Grip® lockbolts

	No.	
1	145 0977	Housing unit
2	145 0970	Protecting cap
3	143 5908	Bolt
4	143 5911	Bolt
5	143 5914	Spacer
6	143 5919	Fork head
7	143 5993	Nosepiece C6L
8	143 5942	Nosepiece Magna-Grip®
9	143 5952	Ring
10	143 5994	Steel head sleeve
11	143 5935	Piece
12	143 5995	Supporting ring C6L
13	143 5943	Supporting ring Magna-Grip®
14	143 5936	Angle
15	143 5938	Lock activator
16	143 5996	Lock activator
17	143 5959	Adapter
18	144 6116	Insertion tool C6L
19	144 6105	Insertion tool Magna-Grip®
20	143 5997	Housing
21	144 6013	Screw
22	144 6012	O-ring
23	144 5716	Washer
24	144 5545	Snap ring
25	145 7992	Tool head, assembled
26	144 6013	Oil screw plug
27	143 5612	Sealing ring M4
28 •	143 5629	O-ring
29	143 5681	Seal holder, complete
30 •	143 4227	O-ring
31 •	143 5630	Rod seal
32	143 5631	Draw bar
33 •	143 5632	Piston seal
34 •	143 5488	Supporting ring
35 •	143 5485	Piston seal
36	143 5671	O-ring
37	145 7746	Resetting piston, complete
38 •	143 5633	Piston seal
39	143 5635	Rod seal
40	143 5765	Connecting piece
41	143 5519	O-ring
42	144 6167	Snap ring

	No.	
43	143 5524	O-ring
44	143 5532	End cap
45	144 6028	Retaining spring
46	143 5664	Retainer
47	143 5663	Adapter
48	143 5842	Lock washer
49	143 5766	Connecting piece nut
50	143 5964	Spent mandrel container, complete
51 •	143 5472	Flat gasket 1
52	145 7748	Grip, complete
53	145 7747	Distributing valve complete
54	144 6025	Activation button
55	143 5642	Slider
56	143 5686	Orifice
57 •	143 5480	Flat gasket
58	143 5998	Grip, complete
59	145 7993	Air cylinder, complete
60	145 7750	Pressure relief valve
61	143 5484	O-ring
62	145 7956	Silencer
63	143 5667	Connecting nipple
64	144 6030	Sealing ring
65	143 5648	Spacer cage
66	143 5647	Rod seal
67	143 5651	Control piston
68 •	143 5675	Piston seal
69	143 5652	Piston housing
70	143 5688	O-ring
71	144 6100	Stopper
72	144 5773	Housing screw
73	143 5486	O-ring
74	143 5492	Alu nut
75 •	143 6007	Piston seal
76 •	143 6006	Guide ring
77	145 7994	Air piston complete
78 •	143 5937	O-ring
79	144 6082	V-ring
80	143 5927	O-ring
81	145 7995	Cylinder complete
82	143 5874	Bottom
83	143 5900	Rubber foot

• Wearing parts

 The suitability of nosepiece and fastener needs to be tested by the user and is user's own responsibility!

# LOCKBOLT SETTING TOOLS

## TAURUS® 3 SRB

for 4,8mm (3/16") C6L and Magna-Grip® lockbolts

## TAURUS® 4 SRB

for 6,4mm (1/4") C6L and Magna-Grip® lockbolts

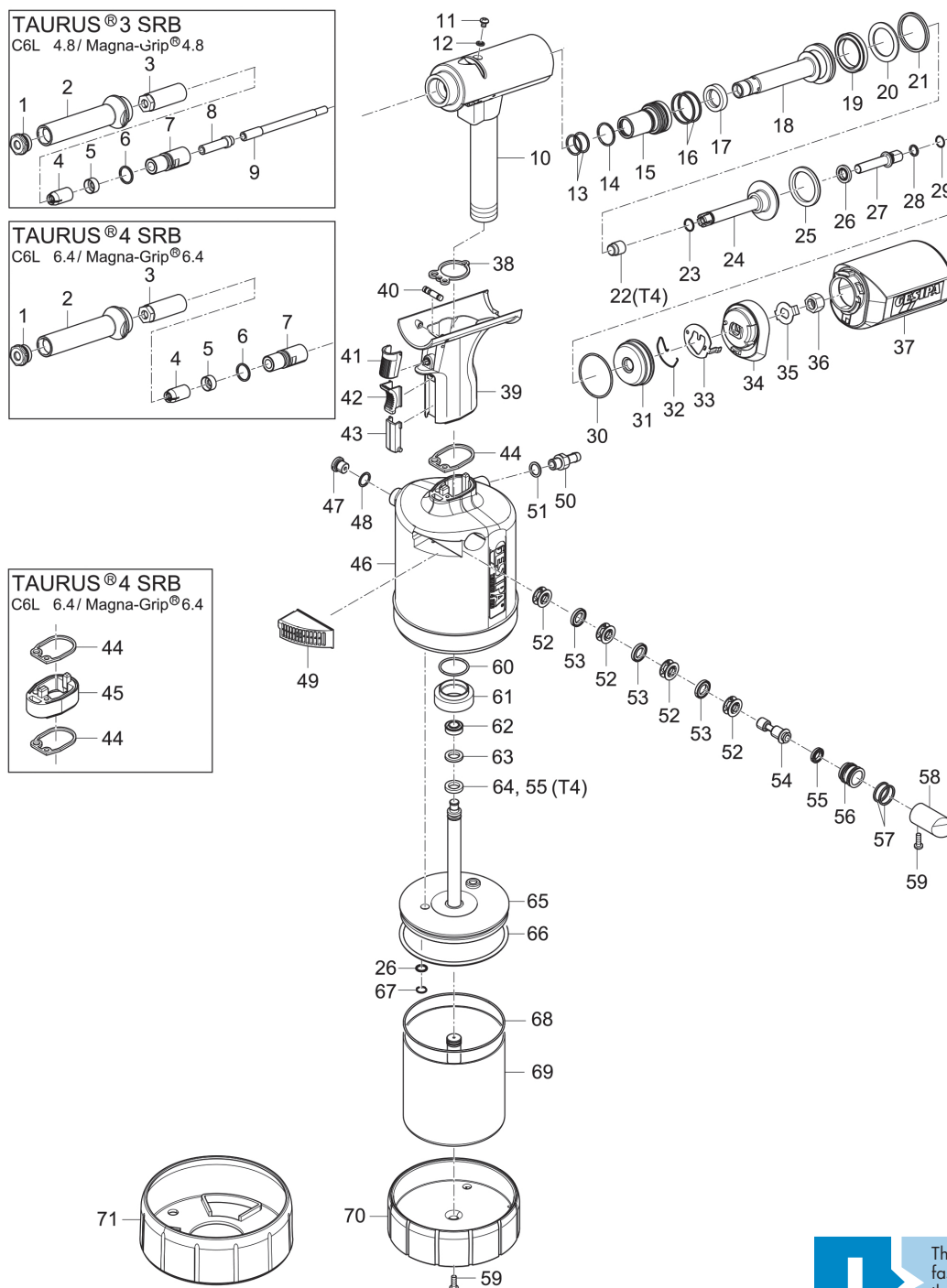

**!** The suitability of nosepiece and fastener needs to be tested by the user and is user's own responsibility!



# LOCKBOLT SETTING TOOLS

## TAURUS® 3 SRB

for 4,8mm (3/16") C6L and Magna-Grip® lockbolts

## TAURUS® 4 SRB

for 6,4mm (1/4") C6L and Magna-Grip® lockbolts

		No.	
1 •	<b>T3</b>	143 4809	Nosepiece C6L
		143 4810	Nosepiece Magna-Grip®
	<b>T4</b>	143 5993	Nosepiece C6L
		143 5942	Nosepiece Magna-Grip®
2		143 5923	Steel head sleeve
3	<b>T3</b>	143 5944	Clamping jaw housing C6L
		143 5945	Clamping jaw housing Magna-Grip®
	<b>T4</b>	143 5997	Clamping jaw housing
4 •	<b>T3</b>	144 6117	Clamping jaw C6L
		144 6118	Clamping jaw Magna-Grip®
	<b>T4</b>	144 6116	Clamping jaw C6L
		144 6105	Clamping jaw Magna-Grip®
5		143 5995	Supporting ring C6L
	<b>T4</b>	143 5943	Supporting ring Magna-Grip®
6		143 6042	O-ring
7		143 5924	Adapter
8	<b>T3</b>	143 5920	Sleeve
9	<b>T3</b>	143 5886	Nozzle tube 3, longe
10	<b>T3</b>	145 7856	Tool head 2, assembled
	<b>T4</b>	145 7992	Tool head 4, assembled
11		144 6013	Oil screw plug
12		143 5612	Sealing ring M4
13		144 6012	O-ring
14		143 5629	O-ring
15		143 5681	Seal holder, complete
16 •		143 4227	O-ring
17		143 5630	Rod seal
18		143 5631	Draw bar
19		143 5632	Piston seal
20		143 5488	Supporting ring
21		143 5485	Piston seal
22	<b>T4</b>	145 0965	Spacer sleeve
23		143 5671	O-ring
24		145 7746	Resetting piston, complete
25		143 5633	Piston seal
26		143 5635	Rod seal
27		143 5765	Connecting piece 2/3
28		143 5519	O-ring
29		144 6167	Snap ring
30		143 5524	O-ring
31		143 5532	End cap
32		144 6028	Retaining spring
33		143 5664	Retainer
34		143 5663	Adapter
35		143 5842	Lock washer
36		143 5766	Connecting piece nut 2/3
37		143 5964	Spent mandrel container, complete
38		143 5472	Flat gasket 1
39		145 7748	Grip, complete
40		145 7747	Distributing valve, complete
41		144 6025	Activation button
42		143 5642	Slider
43		143 5686	Orifice
44		143 5480	Flat gasket 2

		No.	
45	<b>T4</b>	143 5998	Grip extension
46	<b>T3</b>	145 0960	Air cylinder 3, complete
	<b>T4</b>	145 0996	Air cylinder 4, complete
47		145 7750	Pressure relief valve, complete
48		143 5484	O-ring
49		145 7956	Silencer 3, complete
50		143 5667	Connecting nipple
51		144 6030	Sealing ring
52		143 5648	Spacer cage
53		143 5647	Rod seal
54		143 5651	Control piston
55		143 5675	Piston seal
56		143 5652	Piston housing
57		143 5688	O-ring
58		144 6100	Stopper 3
59		144 5773	Housing screw short
60		143 5486	O-ring
61		143 5492	Al nut
62	<b>T3</b>	143 5841	Piston seal
	<b>T4</b>	143 6007	Piston seal
63	<b>T3</b>	143 5825	Guide ring 2
	<b>T4</b>	143 6006	Guide ring 4
64	<b>T3</b>	143 5670	Piston seal
65	<b>T3</b>	145 7952	Air piston 3, complete
	<b>T4</b>	145 7994	Air piston 4, complete
66		143 5937	O-ring
67		144 6082	V profile ring
68		143 5927	O-ring
69	<b>T3</b>	145 7953	Cylinder 3, complete
	<b>T4</b>	145 7995	Cylinder 4, complete
70		143 5874	Bottom 3
71		143 5900	Rubber foot 3 - 4
		144 5294	Hydraulic oil refill bottle, 100 ml

• Wearing parts



The suitability of nosepiece and fastener needs to be tested by the user and is user's own responsibility!

# BLIND RIVET HAND NUT SETTING TOOLS

## GBM 5

No.	
145 7165	Tool housing
145 7166	Tool shanks
145 7167	Bolt
145 7168	Snap ring
145 6608	Strap
145 6609	Spring dowel sleeve
145 6610*	Self opening spring
145 7169	Lock activator
145 7170	Adjusting ring
145 7171	Knurled nut
145 7172	Locking nut
145 7173*	Nosepiece M 4
145 7174*	Nosepiece M 5
145 7175*	Nosepiece M 6
145 7176*	Threaded mandrel M 4
145 7177*	Threaded mandrel M 5
145 7178*	Threaded mandrel M 6

### \* Wearing parts

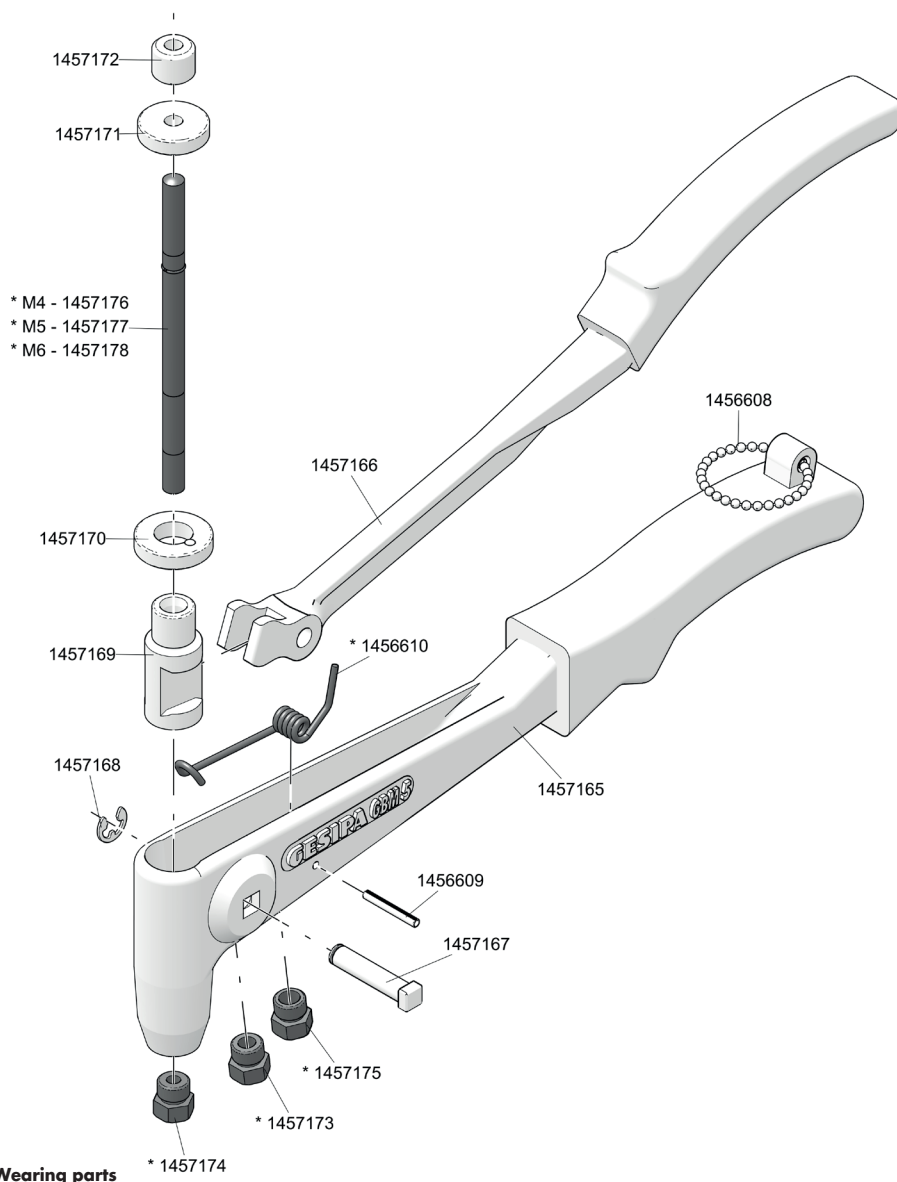

# BLIND RIVET HAND NUT SETTING TOOLS

## GBM 10

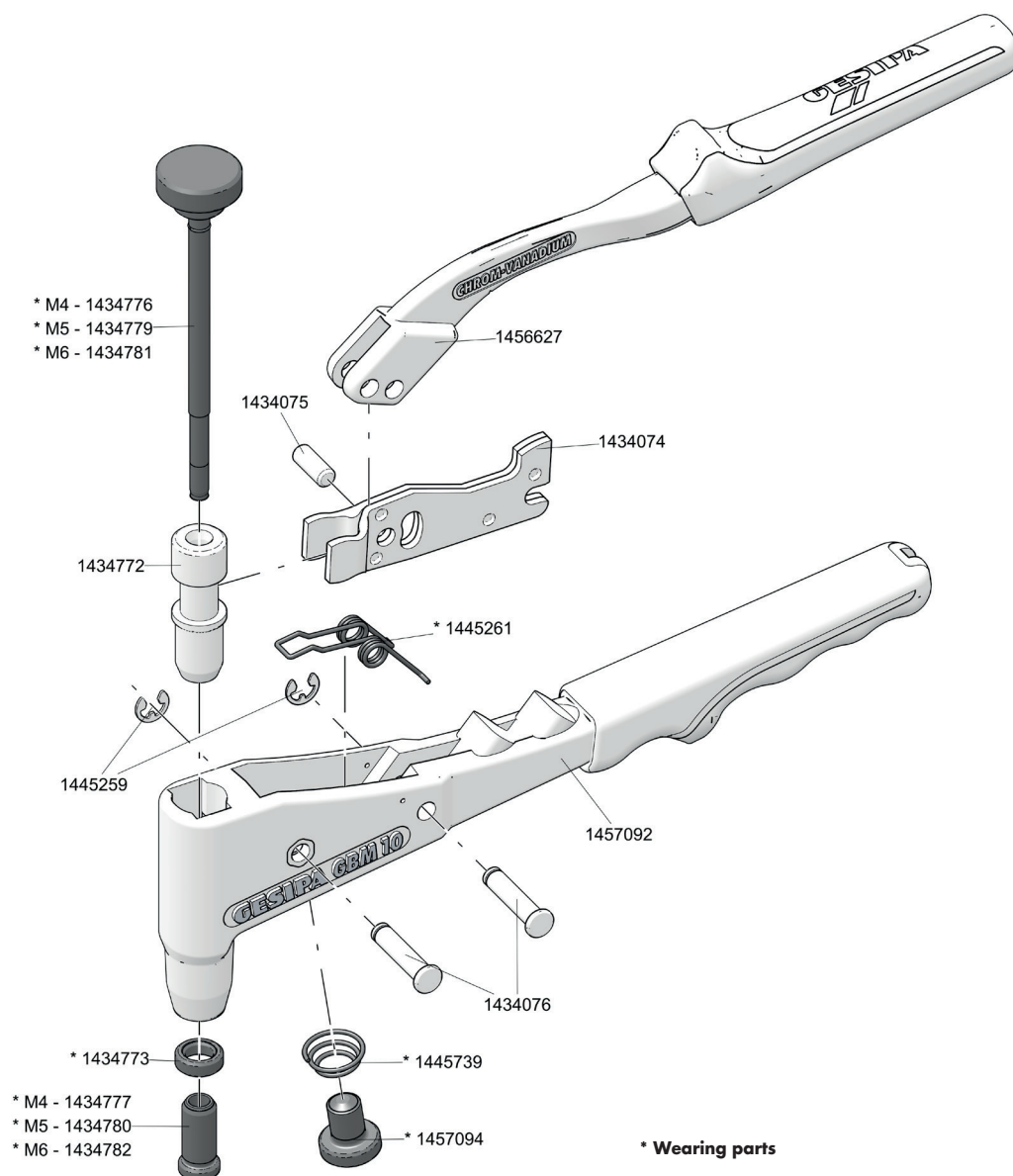

No.	
143 4074	Lever
143 4075	Bolt
143 4076	Bolt
143 4772	Lock activator
143 4773*	Locking nut
143 4776*	Threaded mandrel M 4
143 4777*	Nosepiece M 4 and 8-32"
143 4779*	Threaded mandrel M 5
143 4780*	Nosepiece M 5 and 10-32"
143 4781*	Threaded mandrel M 6
143 4782*	Nosepiece M 6 and 1/4"-20"
144 5259	Snap ring
144 5261*	Self opening spring
144 5739*	Conical spring
145 6627	Tool shanks with sleeve grip
145 7092	Tool housing with sleeve grip
145 7094	Stop screw

### \* Wearing parts



# BLIND RIVET HAND NUT SETTING TOOLS

## GBM 40-R

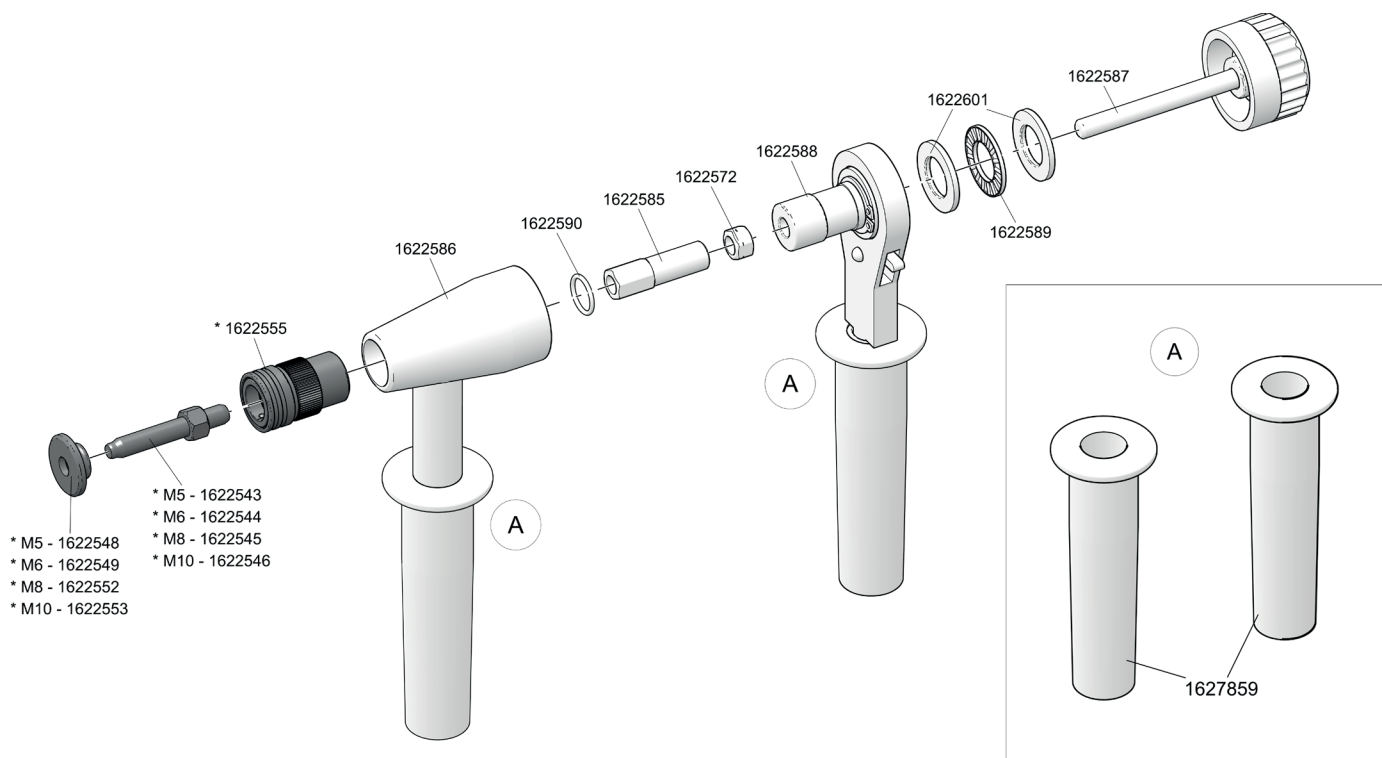

No.		No.	
162 2543*	Threaded mandrel M5	162 2572	Locking nut
162 2544*	Threaded mandrel M6	162 2585	Connecting sleeve
162 2545*	Threaded mandrel M8	162 2586	Housing with slide block, lever and grip
162 2546*	Threaded mandrel M10	162 2587	Turning handle
162 2548*	Nosepiece-bit M5	162 2588	Ratchet with Sleeve grip
162 2549*	Nosepiece-bit M6	162 2589	Needle bearing
162 2552*	Nosepiece-bit M8	162 7859	Sleeve grip
162 2553*	Nosepiece-bit M10	162 2590	O-ring
162 2555*	Nosepiece complete	162 2601	Sliding disc

\* Wearing parts



\* Wearing parts

# GBM 50

No.		No.		No.	
162 2543*	Threaded mandrel M5	162 2571	Connecting sleeve	162 2581	Bolt
162 2544*	Threaded mandrel M6	162 2572	Locking nut	162 2582	Radial bearing
162 2545*	Threaded mandrel M8	162 2573*	Adjusting sleeve	162 2583	Bolt
162 2546*	Threaded mandrel M10	162 2574	Steel head sleeve	162 2584	Lever with Sleeve grip
162 2548*	Nosepiece-bit M5	162 2575	Guide sleeve	162 6916	Threaded mandrel M3
162 2549*	Nosepiece-bit M6	162 2576*	Spring	162 7859	Sleeve grip
162 2552*	Nosepiece-bit M8	162 2577	Closure screw		
162 2553*	Nosepiece-bit M10	162 2578	Shaft		
162 2555*	Nosepiece complete	162 2579	Shaft complete		

**\* Wearing parts**

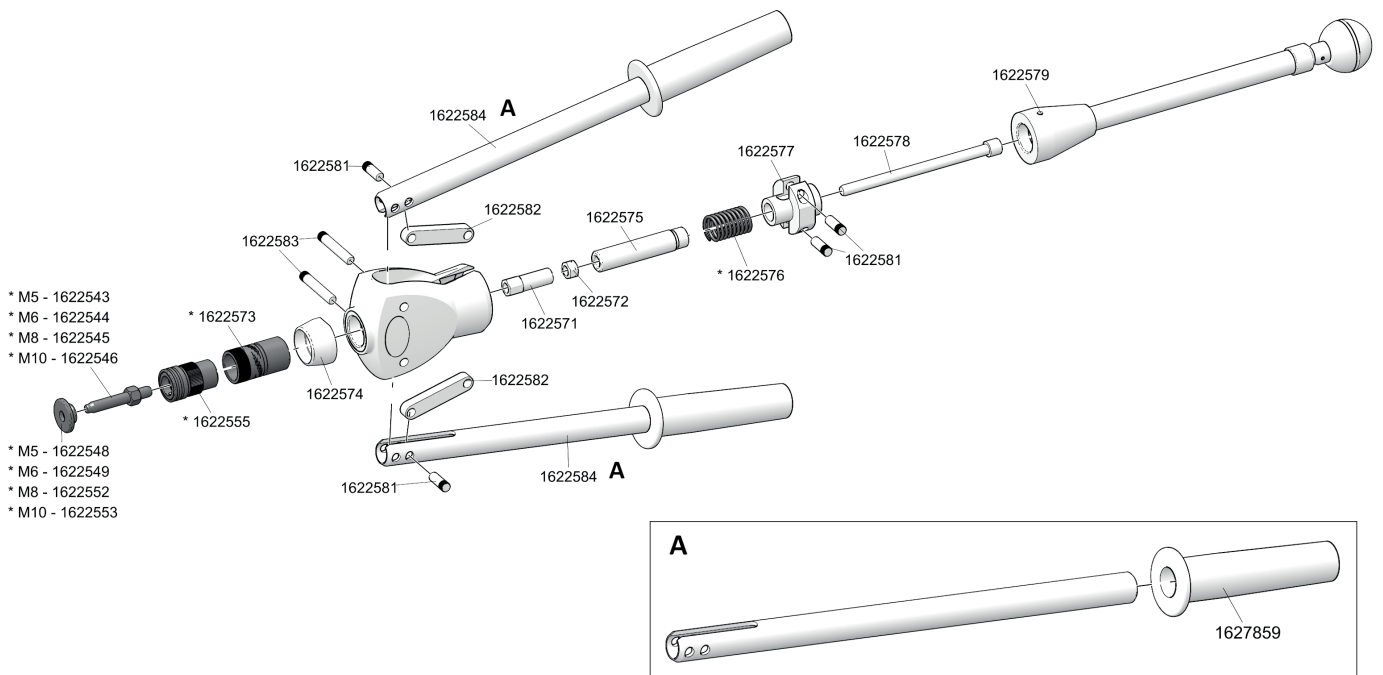

**\* Wearing parts**

# BLIND RIVET HAND NUT SETTING TOOLS

## FireFly

No.	
143 3967	Pivot bolt
143 3968	Snap ring
143 3972*	Return spring
143 3974	Drive pawl
143 3975	Storage finger (3-part) per set
143 3976	Bolt
143 3977*	Self opening spring
143 3978	Retaining spring
143 3979	Spring dowel sleeve
143 3993*	Nosepiece-bit - M5
143 3994*	Nosepiece-bit - M4
143 3995*	Nosepiece-bit - M3
143 3997*	Nosepiece-bit - M6
143 3998	Knurled handle
143 3999*	Nosepiece
143 4000*	Threaded mandrel M5
143 4001*	Threaded mandrel M4
143 4002*	Threaded mandrel M3

No.	
143 4008*	Threaded mandrel M6
143 4019*	Threaded mandrel 6-32 UNC
143 4020*	Threaded mandrel 8-32 UNC
143 4021*	Threaded mandrel 10-24 UNC
143 4022*	Threaded mandrel 10-32 UNF
143 4023*	Threaded mandrel 1/4"-20 UNC
143 4024*	Nosepiece-bit 6-32 UNC
143 4025*	Nosepiece-bit 8-32 UNC
143 4026*	Nosepiece-bit 10-24 UNC/10-32 UNF
143 4027*	Nosepiece-bit 1/4"-20 UNC
143 5671	O - ring
144 5251	Knurled nut
144 5252	Clamping sleeve
144 5253	Snap ring
145 6591	Actuating lever with Sleeve grip
145 6594	Adjustment unit
145 6595	Lock activator complete
166 8828	Housing

### \* Wearing parts

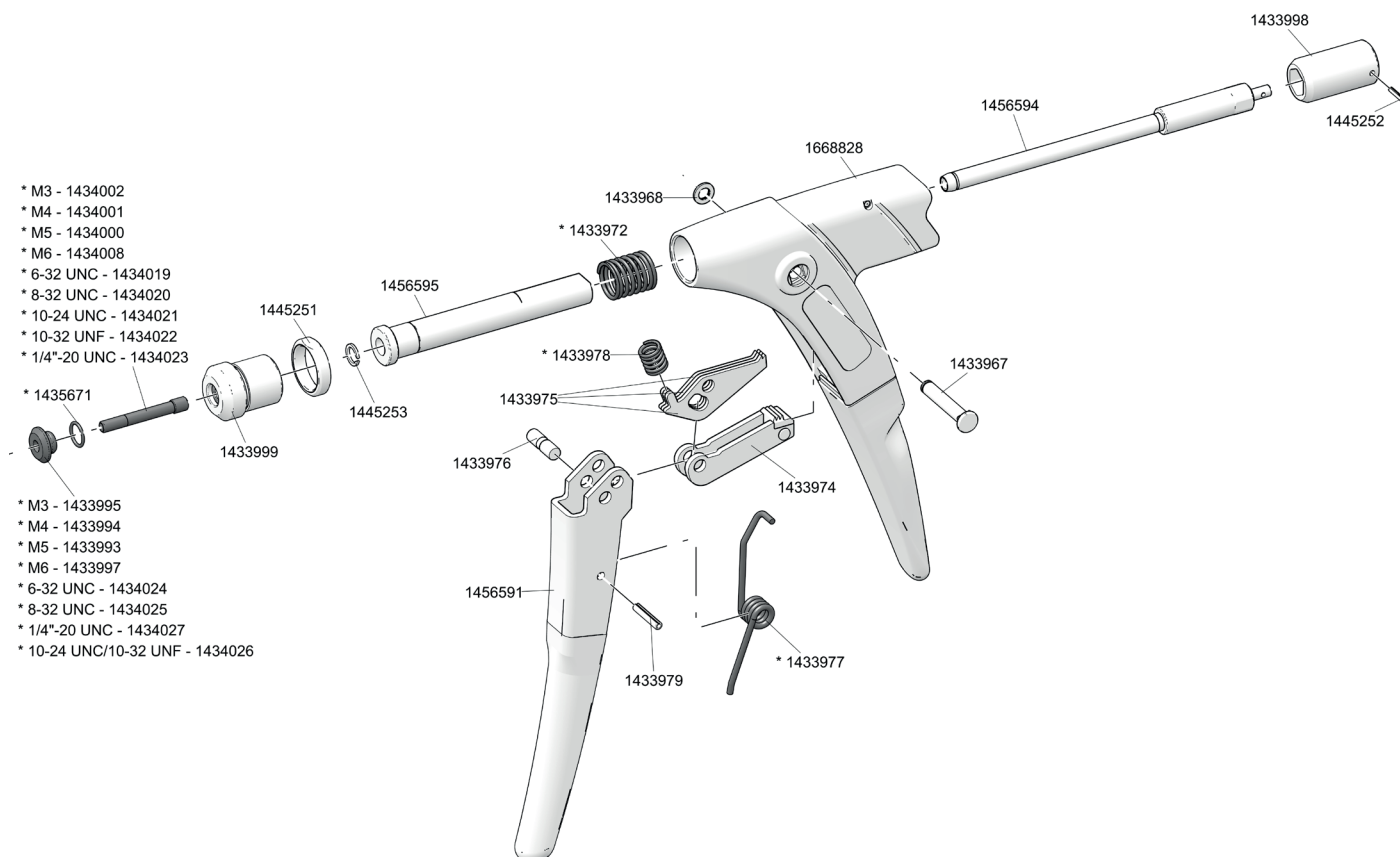

### \* Wearing parts

# BLIND RIVET HAND NUT SETTING TOOLS

## Flipper® Plus

No.	
143 3959*	Jaw housing
143 3967	Pivot bolt
143 3968	Snap ring
143 3969	Lock activator
143 3970*	Jaw Pusher
143 3971*	Compression spring
143 3972*	Compression spring
143 3974	Drive pawl
143 3975	Storage finger (3-part) per set
143 3976	Bolt
143 3977*	Self opening spring
143 3978*	Retaining spring
143 3979	Spring dowel sleeve
143 3981*	O-ring
143 4071*	Jaws (2-part)
157 2917	Assembly aid
157 2918	Assembly key

No.	
157 2920*	Nosepiece 12/20
157 2924*	Nosepiece 12/24
157 2925*	Nosepiece 12/29
157 2926*	Nosepiece M4
157 2927*	Nosepiece M5
157 2929*	Nosepiece M6
157 2931	Closure screw
157 2932	Steel head sleeve
157 3064	Spent mandrel container
157 3065*	Draw bar M4
157 3066*	Draw bar M5
157 3067*	Draw bar M6
157 3068*	Jaw mechanism
157 3069*	Jaw mechanism
157 6258	Housing with slide block, lever and grip
158 3766	Hexagon key
166 8829	Actuating lever

### \* Wearing parts

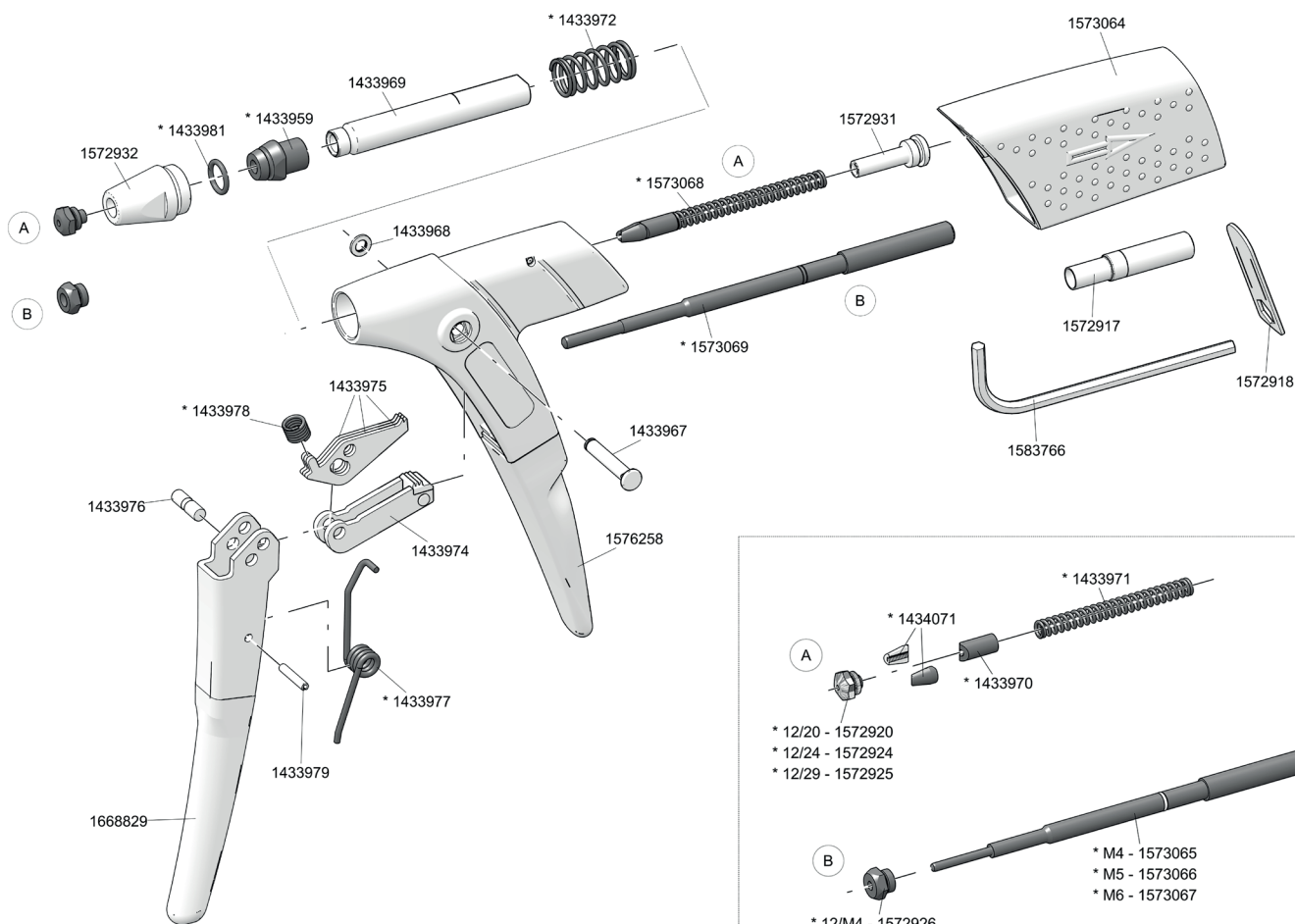

### \* Wearing parts

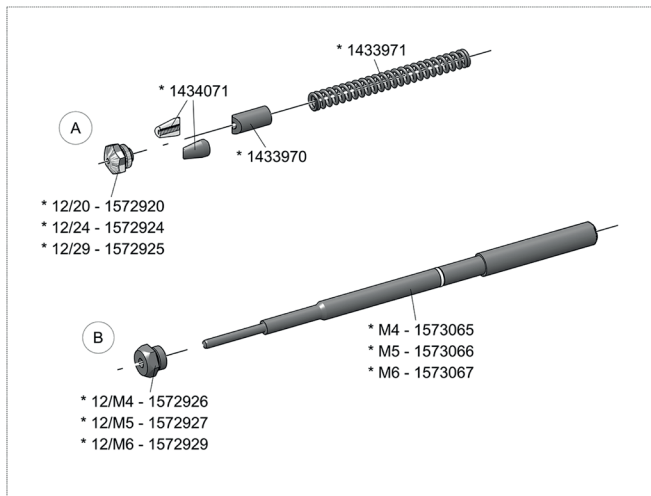

You will find detailed nosepiece allocation tables on page 128.

# BATTERY POWERED BLIND RIVET NUT SETTING TOOLS

**FireBird®**

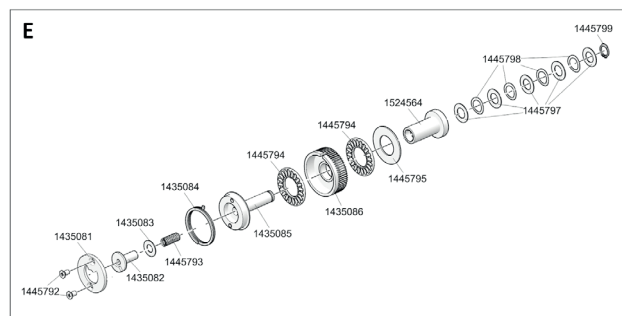
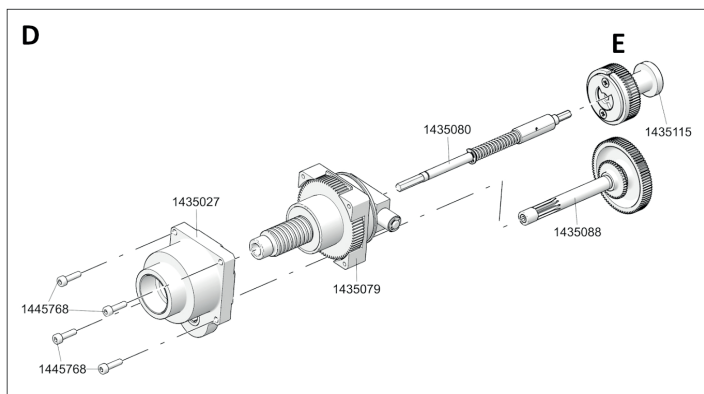
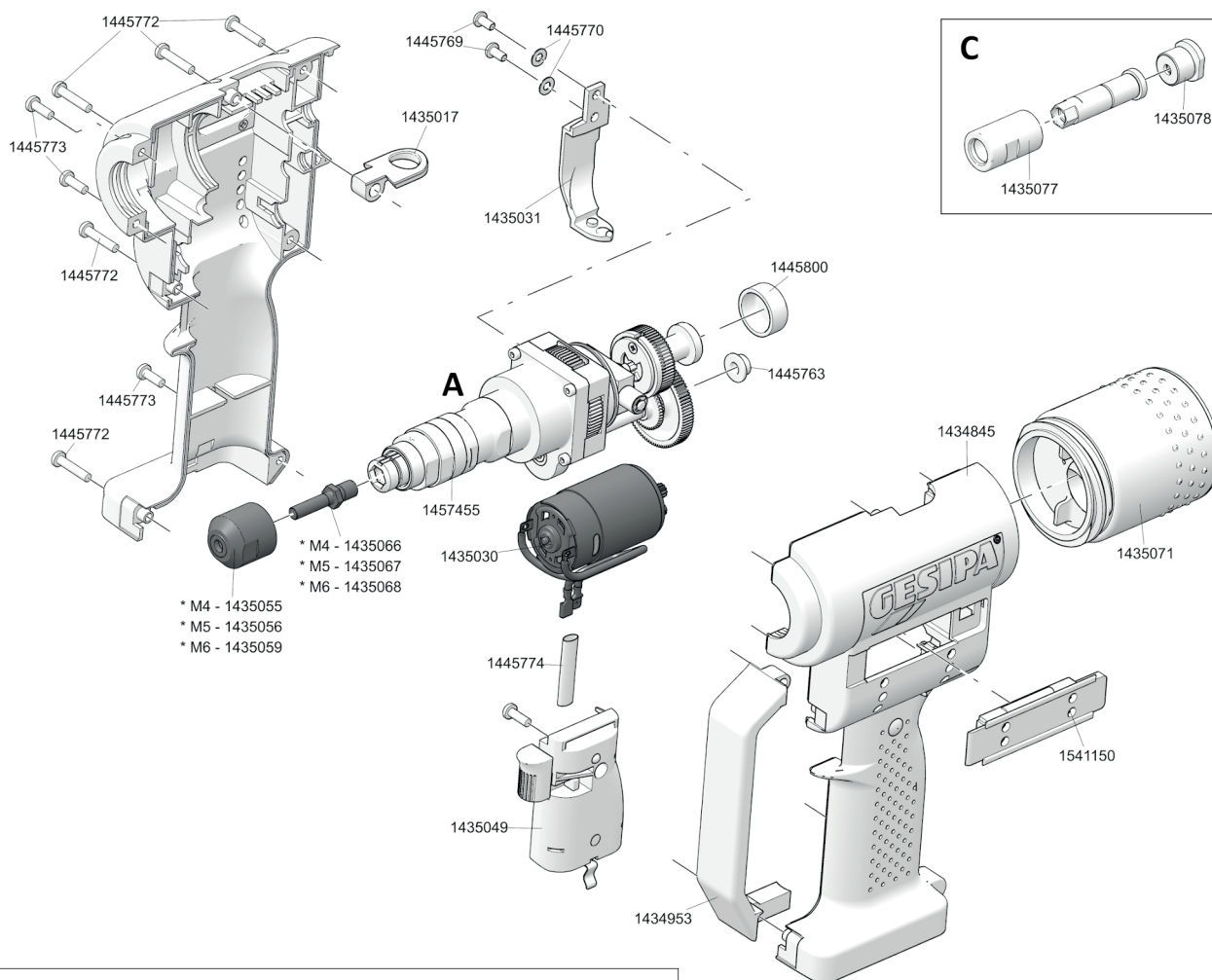
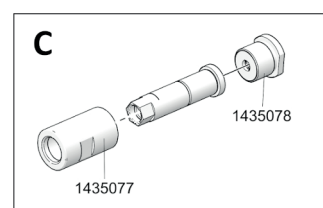
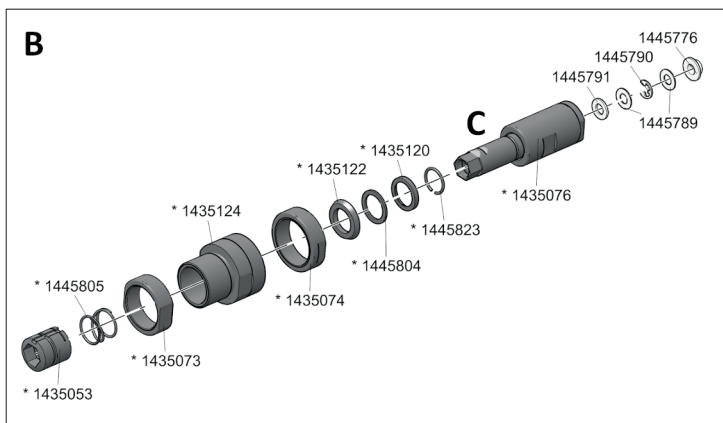
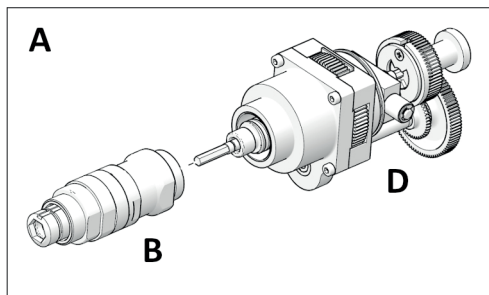



\* Wearing parts



# BATTERY POWERED BLIND RIVET NUT SETTING TOOLS

**FireBird®**

No.	
143 4845	Housing complete
143 4953	Hoop guard
143 5017	Hanger
143 5027	Bearing complete
143 5030*	Motor complete
143 5049	E control
143 5053*	Slider
143 5055*	Threaded mandrel M 4
143 5056*	Threaded mandrel M 5
143 5059*	Threaded mandrel M 6
143 5066*	Nosepiece M 4
143 5067*	Nosepiece M 5
143 5068*	Nosepiece M 6
143 5071	Accessories magazine
143 5073*	Locking nut 2
143 5074*	Locking nut 1
143 5075	Head
143 5076	Driver complete
143 5077	Lock activator
143 5078	Spacer
143 5079	Ball screw drive
143 5080	Rotating rod, complete
143 5081	Plate
143 5082	Rotary driver
143 5083	Washer
143 5084	Wrap spring
143 5085	Shaft
143 5086	Coupling
143 5088	Pinion shaft
143 5115	Coupling complete
143 5120*	Lock washer
143 5122*	Bevel washer
143 5124*	Adjusting sleeve
144 5763	Sintered-metal bushing
144 5768	Allen screw
144 5769	Magnetic holder screw
144 5772	Housing screw short long
144 5773	Housing screw short short
144 5774	Hose complete
144 5776	Slide bearing
144 5789	Washer

No.	
144 5790	Lock Washer
144 5791	Washer
144 5792	Countersunk screw
144 5793	Compression spring
144 5794	Axial needle bearing
144 5795	Axial disc
144 5797	Washer
144 5798	Spring washer
144 5799	Snap ring
144 5800	Cap
144 5804*	Washer
144 5805*	Compression spring
144 5823*	Snap ring
145 7455	Drive unit, complete
152 4564	Bushing
154 1150	End cap
	Threaded mandrels SL
	Nosepieces SL
144 5806	Double open-end spanner SW 24/27

\* Verschleißteile



You will find detailed nosepiece allocation tables on page 242.

# BATTERY POWERED BLIND RIVET NUT SETTING TOOLS

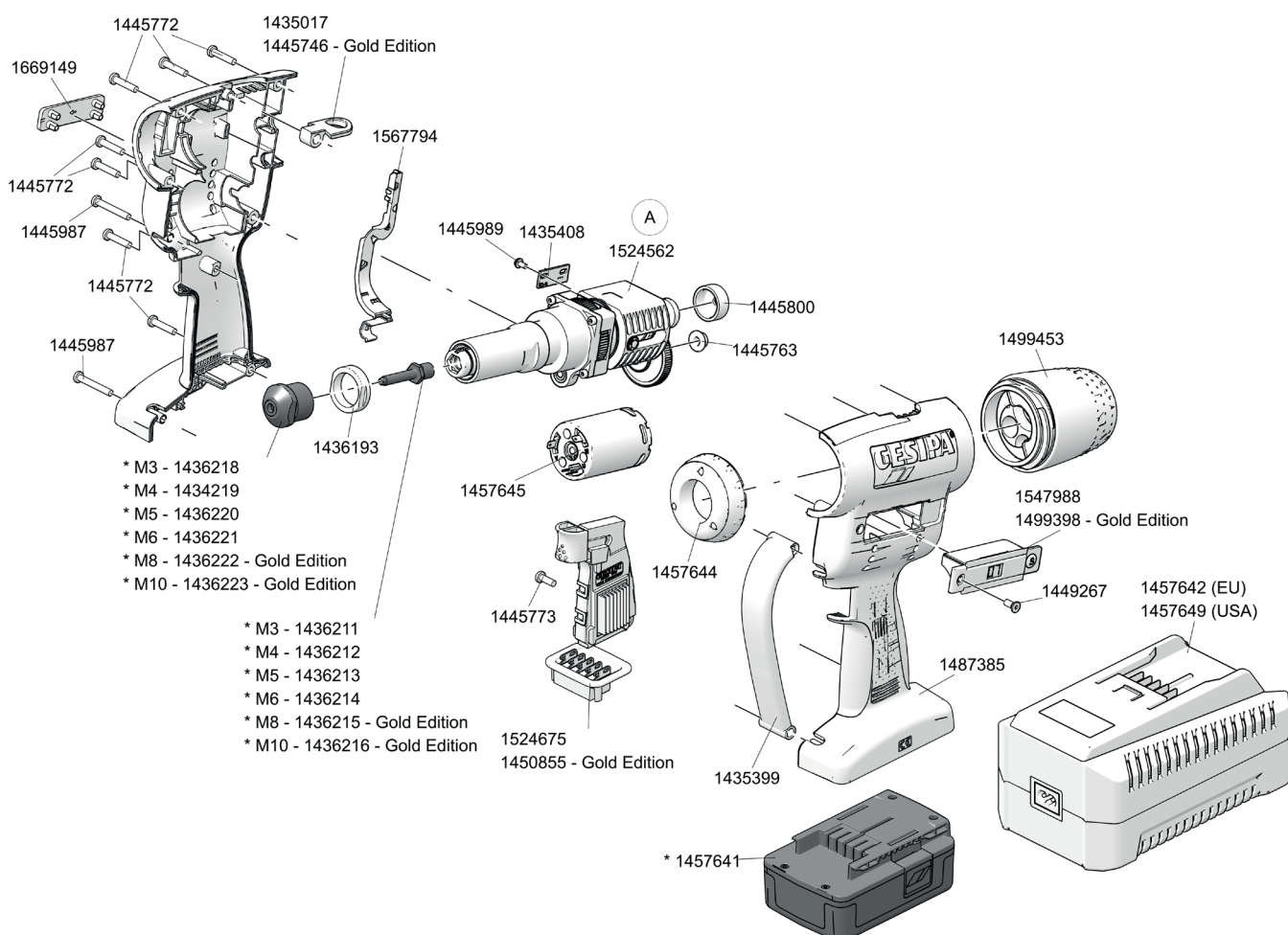
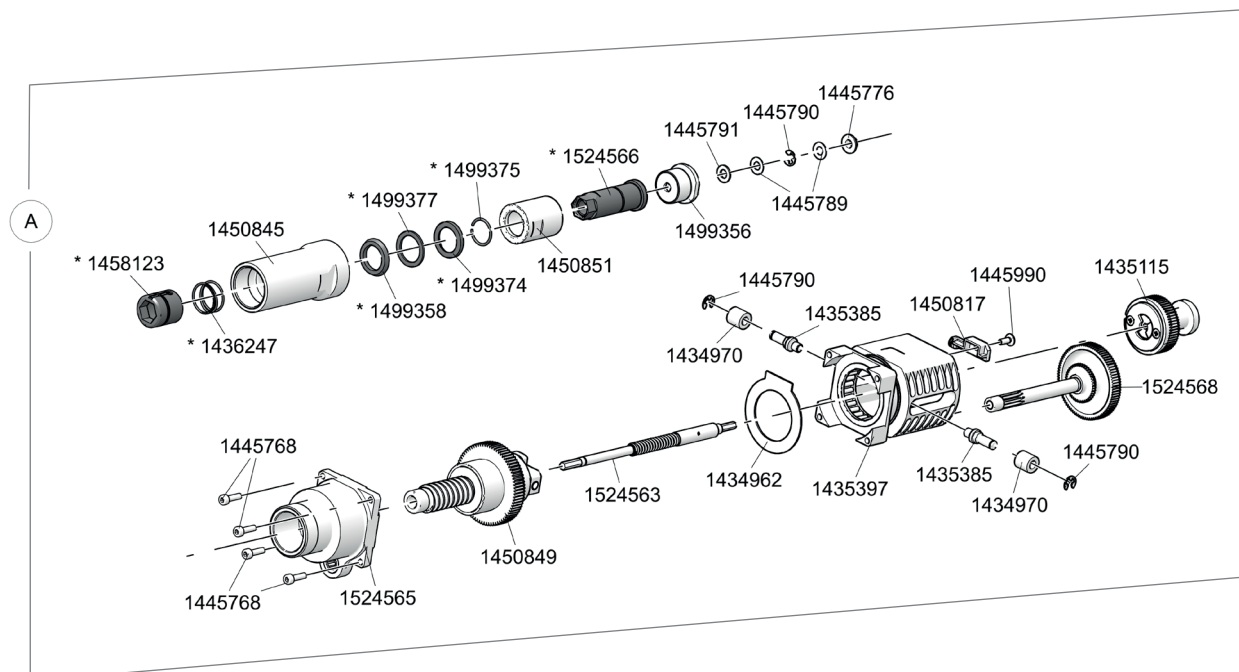

## **FireBird® Pro and FireBird® Pro Gold Edition - until April 2021**





\* Wearing parts

# BATTERY POWERED BLIND RIVET NUT SETTING TOOLS

## **FireBird® Pro and FireBird® Pro Gold Edition - until April 2021**

No.		
143 4962		Pressure disc
143 4970		Sintered metal roller
143 5017	FB Pro	Hanger
143 5082		Rotary driver
143 5083		Washer
143 5084		Wrap spring
143 5085		Shaft
143 5086		Coupling
143 5115		Coupling complete
143 5385		Pin holder
143 5397		Bearing cage
143 5399		Device hanger
143 5408		Hall pcb
143 6193		Locking nut
143 6211*		Threaded mandrel M3
143 6212*		Threaded mandrel M4
143 6213*		Threaded mandrel M5
143 6214*		Threaded mandrel M6
143 6215*	FB Pro GE	Threaded mandrel M8
143 6216*	FB Pro GE	Threaded mandrel M10
143 6218*		Nosepiece M3
143 6219*		Nosepiece M4
143 6220*		Nosepiece M5
143 6221*		Nosepiece M6
143 6222*	FB Pro GE	Nosepiece M8
143 6223*	FB Pro GE	Nosepiece M10
143 6247*		Spring
144 5746	FB Pro GE	Hanger
144 5763		Sintered-metal bushing
144 5768		Screw
144 5772		Screw
144 5773		Screw
144 5776		Plain bearings
144 5789		Washer
144 5790		Snap ring
144 5791		Washer
144 5793		Spring
144 5794		Needle bearing
144 5795		Axial disc
144 5797		Washer

No.		
144 5798		Spring washer
144 5799		Snap ring
144 5800		Cap
144 5987		Screw
144 5989		Screw
144 5990		Screw
144 9267		Screw
145 0817		Magnetic holder complete
145 0845		Head
145 0849		Ball screw drive
145 0851		Lock activator
145 0855	FB Pro GE	Control
145 7641*		Battery - while stocks last
145 7642		Battery charger EU - while stocks last
145 7644		Light, complete
145 7645		Motor
145 7649		Battery charger USA - while stocks last
145 8123*		Slider complete
148 7385		Housing, complete
149 9356		Spacer
149 9358*		Bevel washer
149 9374*		Lock washer
149 9375*		Snap ring
149 9377*		Washer
149 9398	FB Pro GE	Setting force control
149 9453		Accessories magazine
152 4562		Drive unit, complete
152 4563		Rotating rod, complete
152 4564		Coupling bush assy
152 4565		Bearing, complete
152 4566*		Driver
152 4568		Pinion shaft
152 4675		Control FireBird® Pro
154 7988	FB Pro	Setting force control
156 7794		Cable duct
166 9149		Sticker

\* Wearing parts

 You will find detailed nosepiece allocation tables on page 242.

# BATTERY POWERED BLIND RIVET NUT SETTING TOOLS

## FireBird® Pro with new CAS technology - from May 2021

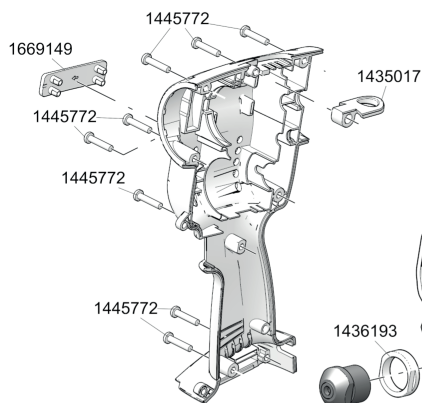
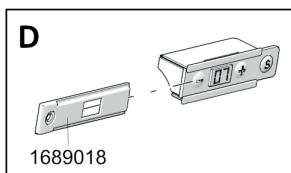
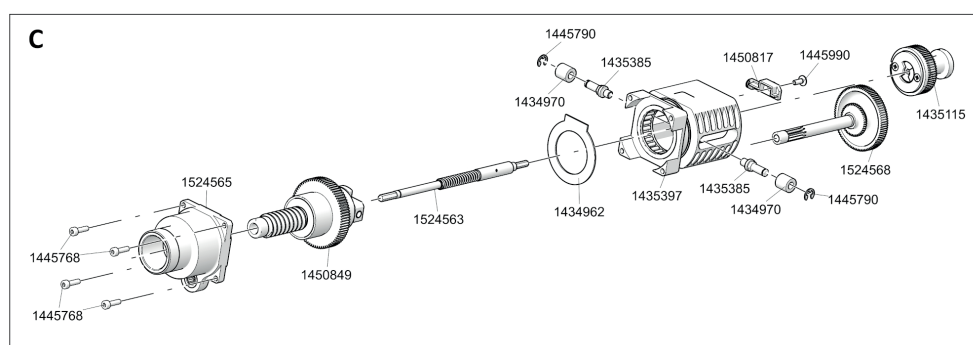
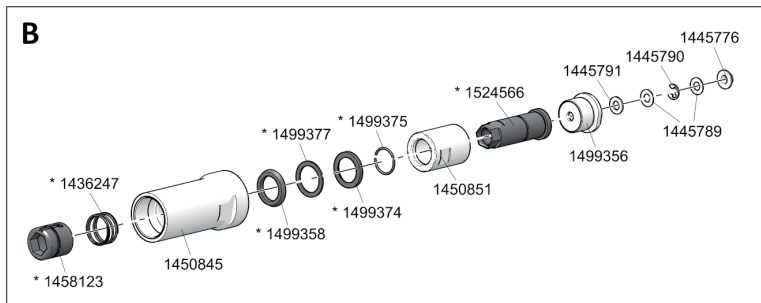
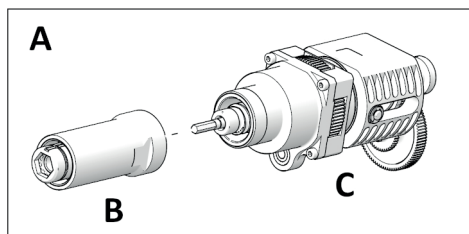

- \* M4 - 1436212
- \* M5 - 1436213
- \* M5 - 1436220
- \* M6 - 1436214
- \* M6 - 1436221

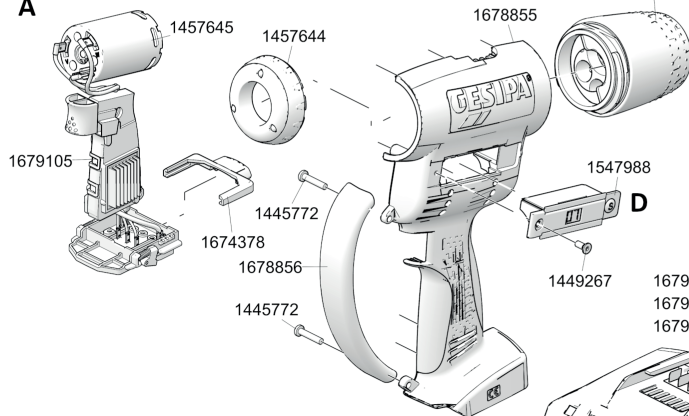
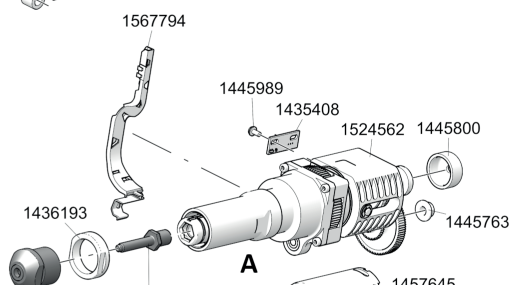

\* 1674373



\* Wearing parts

# BATTERY POWERED BLIND RIVET NUT SETTING TOOLS

## **FireBird® Pro with new CAS technology - from May 2021**

No.	
143 4962	Pressure disc
143 4970	Sintered metal roller
143 5017	Hanger
143 5115	Coupling complete
143 5385	Pin
143 5397	Bearing cage
143 5408	Hall pcb
143 6193	Locking nut
143 6212*	Threaded mandrel M 4
143 6213*	Threaded mandrel M 5
143 6214*	Threaded mandrel M 6
143 6219*	Nosepiece M 4
143 6220*	Nosepiece M 5
143 6221*	Nosepiece M 6
143 6247*	Spring
144 5768	Screw
144 5772	Screw
144 5776	Plain bearings
144 5789	Washer
144 5790	Snap ring
144 5791	Washer
144 5800	Cap
144 5989	Screw
144 5990	Screw
144 9267	Screw
145 0817	Magnetic holder complete
145 0845	Head
145 0849	Ball screw drive
145 0851	Lock activator
145 7644	Light, complete
145 7645	Motor complete
145 8123*	Slider complete

No.	
149 9356	Spacer
149 9358*	Bevel washer
149 9374*	Lock washer
149 9375*	Snap ring
149 9377*	Washer
149 9453	Accessories magazine
152 4562	Drive unit, complete
152 4563	Rotating rod, complete
152 4565	Bearing, complete
152 4566*	Driver
152 4568	Pinion shaft
154 7988	Setting force control
156 7794	Cable duct
166 9149	Sticker
167 4373*	Battery 2.0 Ah
167 4378	Locking slider
167 8855	Housing
167 8856	Hoop guard
167 9105	E control
167 9694	Charger EU
167 9695	Charger UK
167 9696	Charger USA
168 9018	Cover cap

**\* Wearing parts**

 You will find detailed nosepiece allocation tables on page 242.



# BATTERY POWERED BLIND RIVET NUT SETTING TOOLS

**FireBird® Pro Gold Edition with new CAS technology - from May 2021**

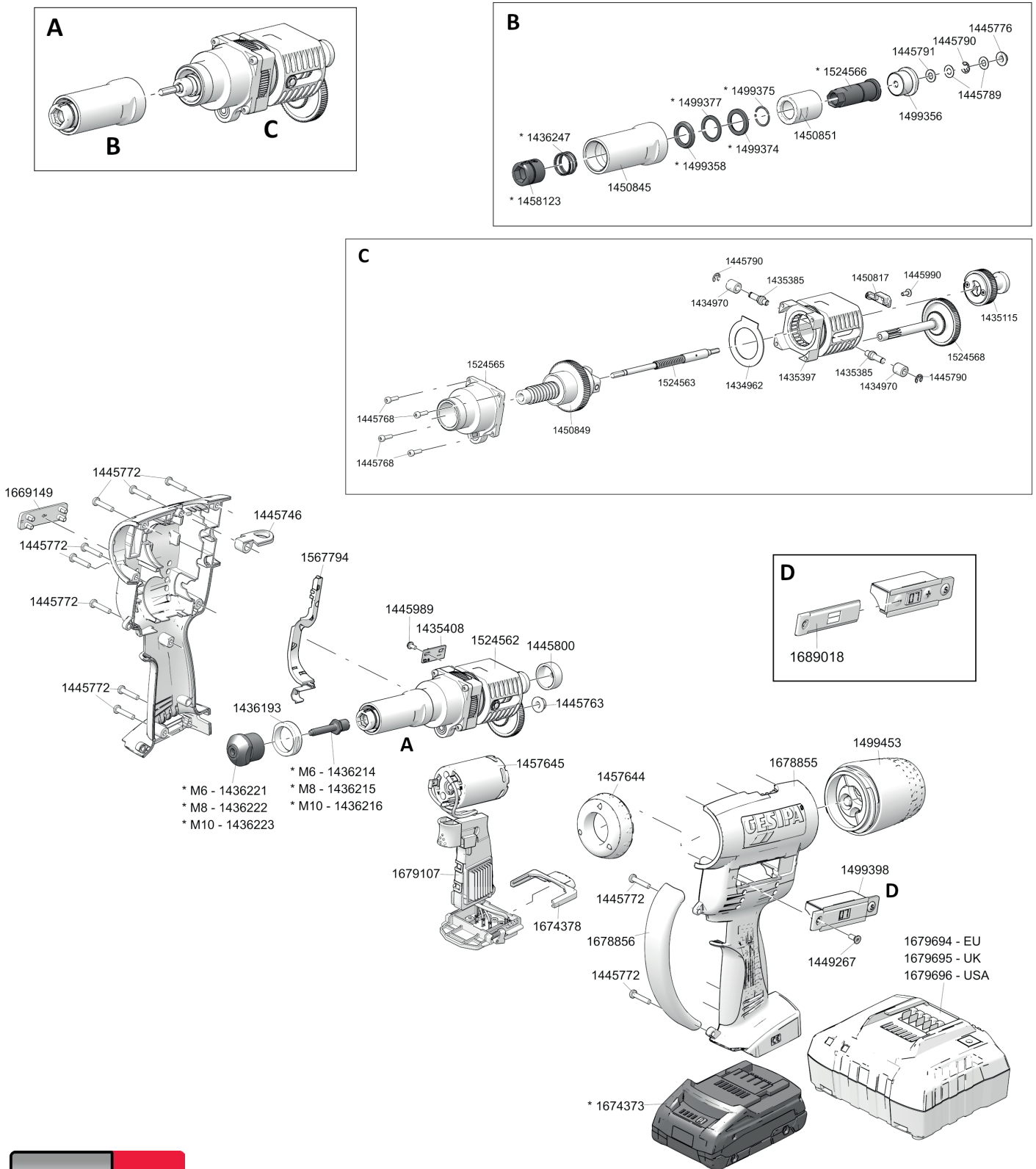

\* Wearing parts

# BATTERY POWERED BLIND RIVET NUT SETTING TOOLS

## **FireBird® Pro Gold Edition with new CAS technology - from May 2021**

No.	
143 4962	Pressure disc
143 4970	Sintered metal roller
143 5115	Coupling complete
143 5385	Pin
143 5397	Bearing cage
143 5408	Hall pcb
143 6193	Locking nut
143 6214*	Threaded mandrel M 6
143 6215*	Threaded mandrel M8
143 6216*	Threaded mandrel M10
143 6221*	Nosepiece M 6
143 6222*	Nosepiece M8
143 6223*	Nosepiece M10
143 6247*	Spring
144 5746	Hanger
144 5763	Sintered-metal bushing
144 5768	Screw
144 5772	Screw
144 5776	Plain bearings
144 5789	Pass-Washer
144 5790	Snap ring
144 5791	Washer
144 5800	Cap
144 5989	Screw
144 5990	Screw
144 9267	Screw
145 0817	Magnetic holder complete
145 0845	Head
145 0849	Ball screw drive
145 0851	Lock activator
145 7644	Light, complete
145 7645	Motor complete
145 8123*	Slider complete

No.	
149 9356	Spacer
149 9358*	Bevel washer
149 9374*	Lock washer
149 9375*	Snap ring
149 9377*	Washer
149 9398	Setting force control
149 9453	Accessories magazine
152 4562	Drive unit, complete
152 4563	Rotating rod, complete
152 4565	Bearing, complete
152 4566*	Driver
152 4568	Pinion shaft
156 7794	Cable duct
166 9149	Sticker
167 4373*	Battery 2.0 Ah
167 4378	Locking slider
167 8855	Housing
167 8856	Hoop guard
167 9107	E control
167 9694	Charger EU
167 9695	Charger UK
167 9696	Charger USA
168 9018	Cover cap

**\* Wearing parts**

 You will find detailed nosepiece allocation tables on page 242.



# BATTERY POWERED BLIND RIVET NUT SETTING TOOLS

## FireBird® Pro S Gold Edition - until April 2021

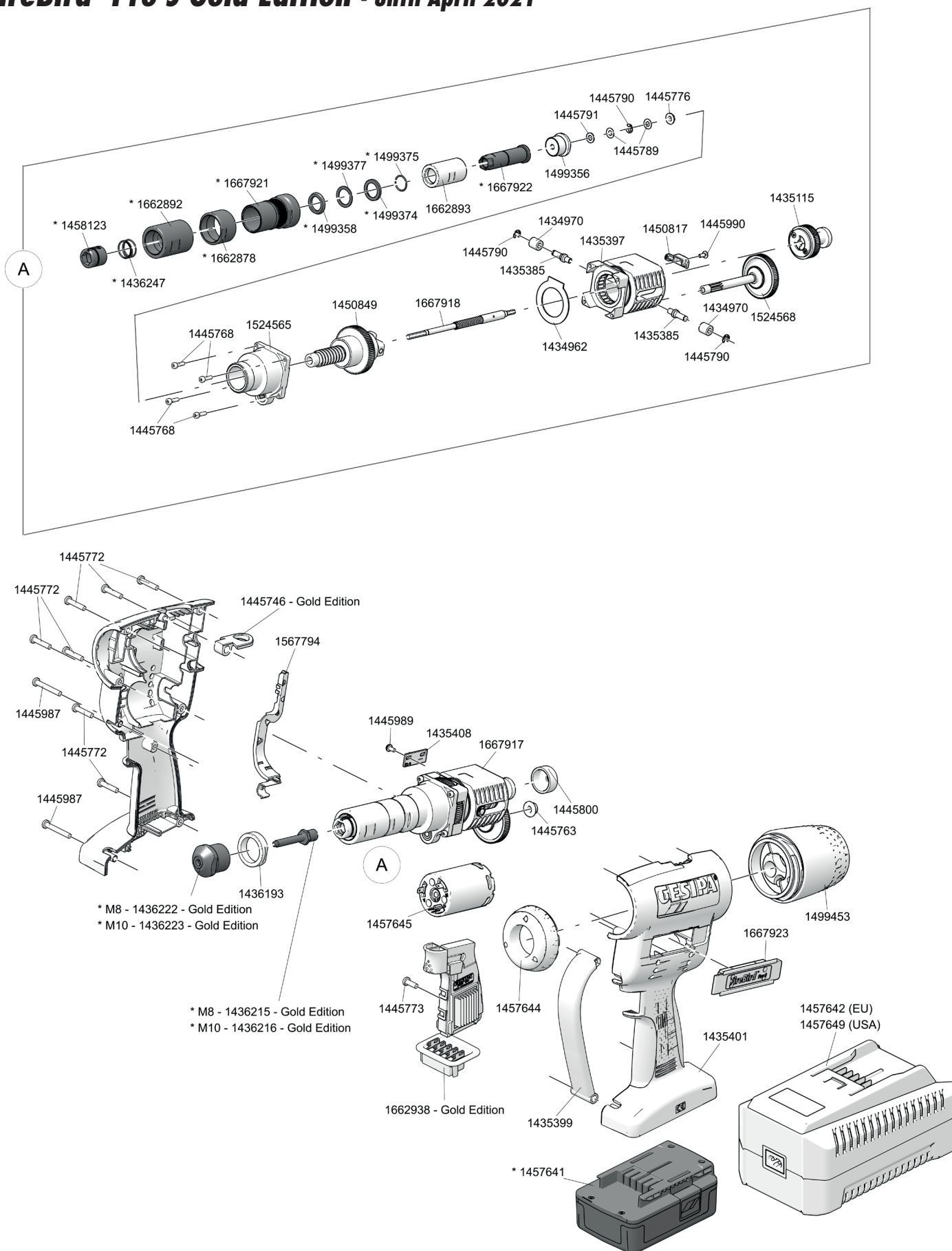

\* Wearing parts



# BATTERY POWERED BLIND RIVET NUT SETTING TOOLS

## **FireBird® Pro S Gold Edition - until April 2021**

No.	
143 4962	Pressure disc
143 4970	Sintered metal roller
143 5115	Coupling complete
143 5385	Pin
143 5397	Bearing cage
143 5399	Device hanger
143 5401	Housing complete
143 5408	LED plate
143 6193	Locking ring
143 6215*	Threaded mandrel M8
143 6216*	Threaded mandrel M10
143 6222*	Nosepiece M8
143 6223*	Nosepiece M10
143 6247*	Spring
144 5746	Hanger Gold Edition
144 5763	Sintered-metal bushing
144 5768	Allen screw
144 5772	Screw
144 5773	Screw
144 5776	Plain bearings
144 5789	Washer
144 5790	Snap ring
144 5791	Washer
144 5800	Cap
144 5987	Screw
144 5989	Screw
145 0817	Magnetic holder
145 0849	Ball screw drive
145 5990	Screw
145 7641*	Battery - while stocks last
145 7642	Battery charger EU - while stocks last
145 7644	Light, complete

No.	
145 7645	Motor
145 7649	Battery charger USA while stocks last
145 8123*	Slider complete
149 9356	Spacer
149 9374*	Washer
149 9375*	Snap ring
149 9377*	Washer
149 9453	Accessories magazine
149 9358*	Washer
152 4565	Bearing
152 4568	Pinion shaft
156 7794	Cable duct
166 2878*	Adjusting nut
166 2892*	Adjusting sleeve
166 2893	Lock activator
166 2938	Control Gold Edition
166 7917	Drive unit, complete
166 7918	Rotating rod
166 7921*	Head
166 7922	Driver
166 7923	Cover

\* Wearing parts





You will find detailed nosepiece allocation tables on page 242.



# BATTERY POWERED BLIND RIVET NUT SETTING TOOLS

## **FireBird® Pro S Gold Edition with new CAS technology - from May 2021**

No.	
143 4962	Pressure disc
143 4970	Sintered metal roller
143 5115	Coupling complete
143 5385	Pin
143 5397	Bearing cage
143 5399	Device hanger
143 5408	LED plate
143 6193	Locking ring
143 6214*	Threaded mandrel M6
143 6215*	Threaded mandrel M8
143 6216*	Threaded mandrel M10
143 6221*	Nosepiece M6
143 6222*	Nosepiece M8
143 6223*	Nosepiece M10
143 6247*	Spring
144 5746	Hanger Gold Edition
144 5763	Sintered-metal bushing
144 5768	Screw
144 5772	Screw
144 5776	Plain bearings
144 5789	Washer
144 5790	Snap ring
144 5791	Washer
144 5800	Cap
144 5989	Screw
144 5990	Screw
145 0817	Magnetic holder
145 0849	Ball screw drive
145 7644	Light, complete

No.	
145 7645	Motor
145 8123*	Slider complete
149 9356	Spacer
149 9374*	Washer
149 9375*	Snap ring
149 9377*	Washer
149 9453	Accessories magazine
152 4565	Bearing
152 4568	Pinion shaft
166 2878*	Adjusting nut
166 2892*	Adjusting sleeve
166 2893	Lock activator
166 7917	Drive unit, complete
166 7918	Rotating rod
166 7921*	Head
166 7922*	Driver
166 7923	Cover
167 4373*	Battery 2.0 Ah
167 4378	Locking slider
167 8855	Housing
167 8856	Device hanger
167 9110	E control

\* Wearing parts

 You will find detailed nosepiece allocation tables on page 242.





# HYDRO-PNEUMATIC BLIND RIVET NUT SETTING TOOLS

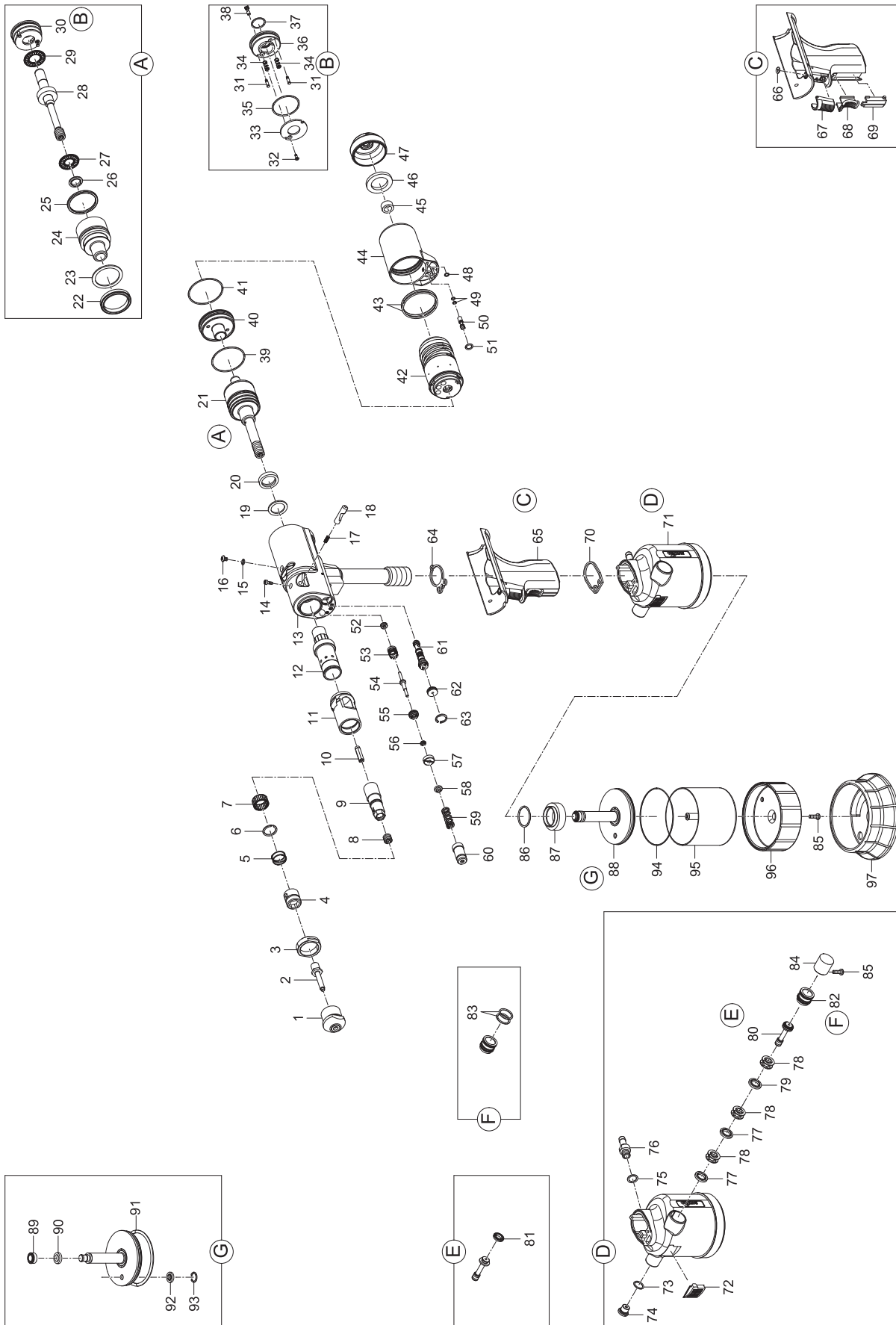

## Firefox® 1



# HYDRO-PNEUMATIC BLIND RIVET NUT SETTING TOOLS

## FireFox® 1

	No.	
1 •	1436218	Nosepiece M 3
	1436219	Nosepiece M 4
	1436220	Nosepiece M 5
	1436221	Nosepiece M 6
2 •	1436211	Threaded mandrel M 3
	1436212	Threaded mandrel M 4
	1436213	Threaded mandrel M 5
	1436214	Threaded mandrel M 6
3	1436193	Locking ring
4	1458123	Slider
5	1436247	Compression spring
6	1446189	Snap ring
7	1446190	Needle ring
8	1446187	Stud bolt
9	1436179	Driver
10	1436201	Hexagonal rod
11	1436192	Steel head sleeve
12	1451094	Stroke adjuster
13	1659541	Tool head assembled
14	1445427	Screw
15	1435612	Sealing ring
16	1446013	Oil screw plug
17	1436244	Spring
18	1436180	Locating bolt
19 •	1436230	Supporting ring
20 •	1436234	Rod seal
21	1605693	Draw bar, complete
22 •	1436227	Piston seal
23 •	1436229	Supporting ring
24	1436204	Draw bar
25 •	1436231	Seal
26	1435236	Seal kit
27	1446191	Axial needle bearing
28	1605692	Tie anchor complete
29	1445794	Axial needle bearing
30	1458125	Closure complete
31	1436183	Plug bolt
32	1446188	Screw
33	1436205	Washer
34	1436293	Spring
35	1436238	O-ring
36	1436197	Closure
37	1436239	O-ring
38	1458124	Valve key complete
39	1436236	O-ring
40	1436198	End cap
41	1436237	O-ring
42	1436168	Air motor complete
43	1436243	O-ring
44	1436170	Adapter
45	1436173	Absorber disc

	No.	
46	1436174	Absorber disc
47	1436175	Noise suppressor cover
48	1436242	O-ring
49	1436291	O-ring
50	1436292	Valve key
51	1435519	O-ring
52	1436233	Rod seal
53	1605656	Bit
54	1605658	Plunger
55	1605657	Sealing washer complete
56	1605600	Groove ring
57	1605592	Threaded ring
58	1436178	Bevel washer
59	1436374	Spring
60	1451112	Spring compressor
61	1436297	Distributing valve, complete
62	1451053	Stopper, complete
63	1445285	Snap ring
64 •	1435472	Flat gasket 1
65	1605659	Grip, complete
66	1436241	O-ring
67	1446025	Activation button
68	1435642	Slider
69	1436169	Orifice
70 •	1435480	Flat gasket 2
71	1605660	Air cylinder, complete
72	1515051	Silencer complete
73	1435484	O-ring
74	1457750	Safety valve, complete
75	1446030	Sealing ring
76	1435667	Connecting nipple
77	1435647	Rod seal
78	1435648	Spacer cage
79	1436248	Washer
80	1605671	Control piston
81 •	1435675	Piston seal
82	1457693	Piston housing
83	1435688	O-ring
84	1446026	Stopper
85	1445773	Screw
86	1435486	O-ring
87	1435492	Al nut
88	1451107	Air piston complete
89 •	1436007	Piston seal
90 •	1436006	Guide ring 4
91 •	1435660	O-ring
92	1435659	Rod seal
93	1446027	Snap ring
94	1435680	O-ring
95	1451111	Cylinder 1, complete
96	1435508	Bottom
97	1436394	Rubber foot

• Wearing parts



You will find detailed nosepiece allocation tables on page 242.  
You will find spare part kits for FireFox® 1 on page 356.



# HYDRO-PNEUMATIC BLIND RIVET NUT SETTING TOOLS

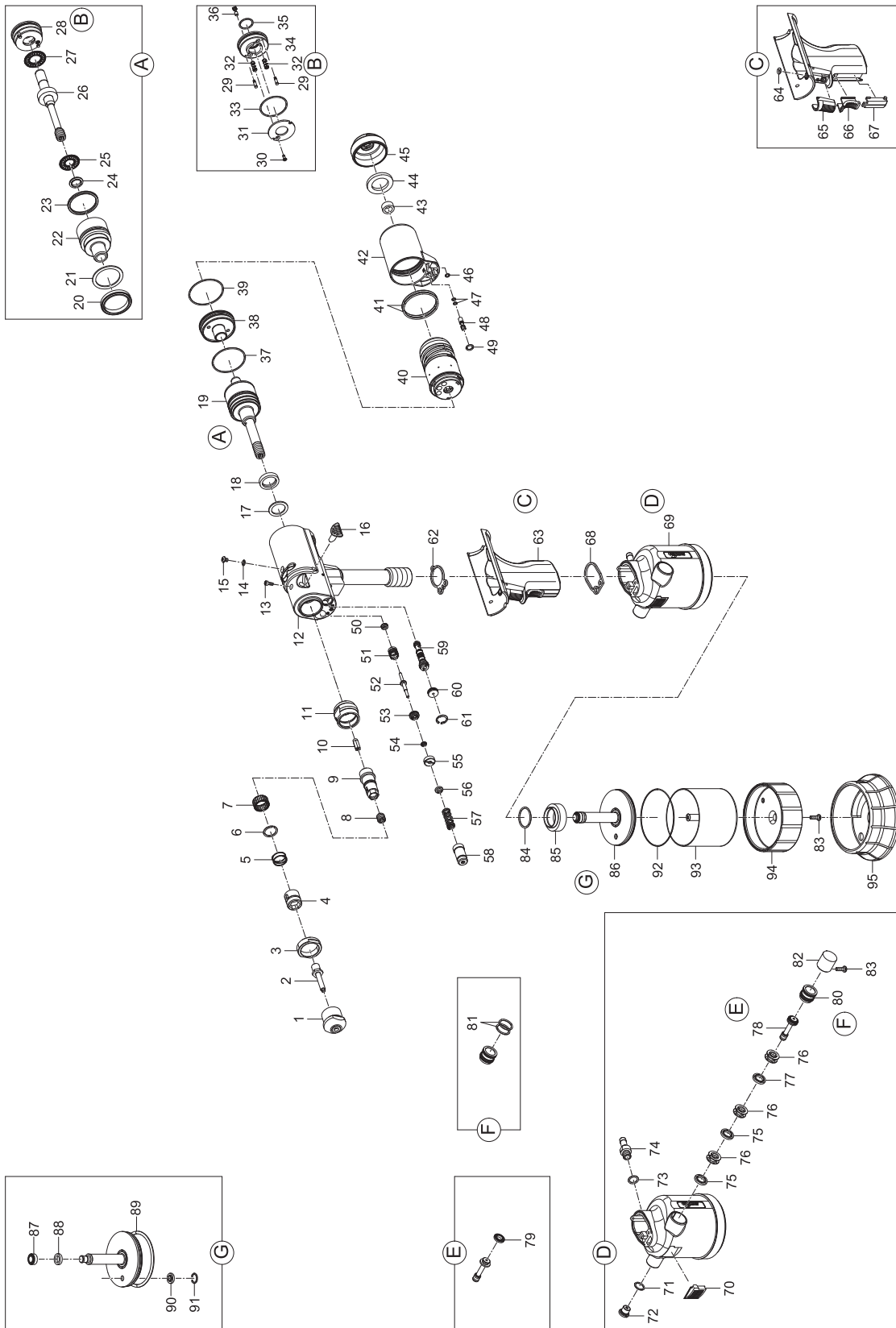

## Firefox® 1 F



# HYDRO-PNEUMATIC BLIND RIVET NUT SETTING TOOLS

## FireFox® 1 F

	No.	
1 •	143 6218	Nosepiece M 3
	143 6219	Nosepiece M 4
	143 6220	Nosepiece M 5
	143 6221	Nosepiece M 6
2 •	143 6211	Threaded mandrel M 3
	143 6212	Threaded mandrel M 4
	143 6213	Threaded mandrel M 5
	143 6214	Threaded mandrel M 6
3	143 6193	Locking ring
4	145 8123	Slider
5	143 6247	Compression spring
6	144 6189	Snap ring
7	144 6190	Needle ring
8	144 6187	Stud bolt
9	143 6181	Driving pin
10	143 6390	Hexagonal rod
11	143 6393	Steel head sleeve 1
12	160 5655	Tool head 1 assembled
13	144 5427	Allen screw
14	143 5612	Sealing ring M4
15	144 6013	Oil screw plug
16	143 6204	Draw bar
17 •	143 6230	Supporting ring
18 •	143 6234	Rod seal
19	145 8201	Draw bar 1, complete
20 •	143 6227	Piston seal
21 •	143 6229	Supporting ring
22	143 6204	Draw bar
23	143 6231	Seal
24 •	143 5236	Seal kit
25	144 6191	Axial needle bearing
26	145 1110	Tie anchor 1, complete
27	144 5794	Axial needle bearing
28	145 8125	Closure complete
29	143 6183	Plug bolt
30	144 6188	Screw
31	143 6205	Washer
32	143 6293	Spring
33	143 6238	Closure
34	143 6197	Closure
35	143 6239	O-ring
36	145 8124	Valve key 4 complete
37	143 6236	O-ring

	No.	
38	143 6198	End cap
39	143 6237	O-ring
40	143 6168	Air motor complete
41	143 6243	O-ring
42	143 6170	Adapler
43	143 6173	Absorber disc 1
44	143 6174	Absorber disc 2
45	143 6175	Noise suppressor cover
46	143 6242	O-ring
47	143 6291	O-ring
48	143 6292	Valve key 5
49	143 5519	O-ring
50	143 6233	Rod seal
51	160 5656	Bit
52	160 5658	Plunger
53	160 5657	Sealing washer complete
54	160 5600	Groove ring
55	160 5592	Threaded ring
56	143 6178	Bevel washer
57	143 6374	Spring
58	145 1112	Spring compressor
59	143 6297	Distributing valve, complete
60	145 1053	Stopper, complete
61	144 5285	Snap ring
62 •	143 5472	Flat gasket 1
63	160 5659	Grip, complete
64	143 6241	O-ring
65	144 6025	Activation button
66	143 5642	Slider
67	143 6169	Orifice
68 •	143 5480	Flat gasket 2
69	160 5660	Air cylinder, complete
70	151 5051	Silencer complete
71	143 5484	O-ring
72	145 7750	Safety valve, complete
73	144 6030	Sealing ring
74	143 5667	Connecting nipple
75	143 5647	Rod seal
76	143 5648	Spacer cage
77	143 6248	Washer
78	160 5671	Control piston
79	143 5675	Piston seal
80	145 7693	Piston housing
81	143 5688	O-ring
82	144 6026	Stopper
83	144 5773	Screw
84	143 5486	O-ring
85	143 5492	Al nut
86	145 1107	Air piston complete
87 •	143 6007	Piston seal
88 •	143 6006	Guide ring 4
89 •	143 5660	O-ring
90	143 5659	Rod seal
91	144 6027	Snap ring
92	143 5680	O-ring
93	145 1111	Cylinder 1, complete
94	143 5508	Bottom 1
95	143 6394	Rubber foot 1
	144 5294	Hydraulic oil refill bottle, 100 ml

• Wearing parts



You will find detailed nosepiece allocation tables on page 242.  
You will find spare part kits for FireFox® 1 F on page 356.

# HYDRO-PNEUMATIC BLIND RIVET NUT SETTING TOOLS

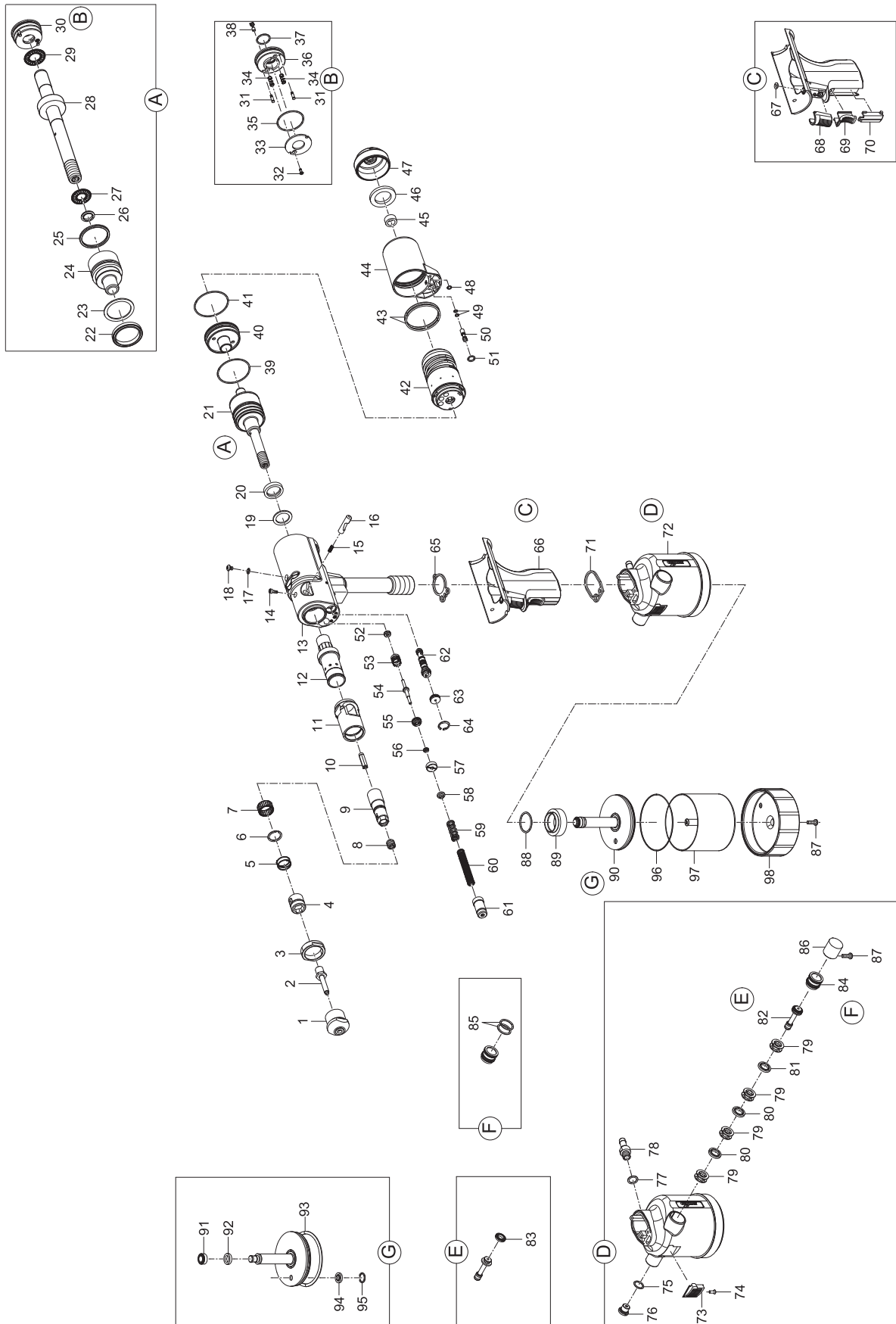

## Firefox® 2







# HYDRO-PNEUMATIC BLIND RIVET NUT SETTING TOOLS

## FireFox® 2

	No.	
1 •	143 6219	Nosepiece M 4
	143 6220	Nosepiece M 5
	143 6221	Nosepiece M 6
	143 6222	Nosepiece M 8
2 •	143 6212	Threaded mandrel M 4
	143 6213	Threaded mandrel M 5
	143 6214	Threaded mandrel M 6
	143 6215	Threaded mandrel M 8
3	143 6193	Locking ring
4	145 8123	Slider complete
5	143 6247	Compression spring
6	144 6189	Snap ring
7 •	144 6190	Needle ring
8	144 6187	Stud bolt
9	143 6179	Driving pin
10	143 6201	Hexagonal rod
11	143 6192	Steel head sleeve
12	145 1094	Stroke adjuster, complete
13	165 9529	Tool head assembled
14	143 6244	Spring
15	143 6180	Locating bolt
16	144 5427	Allen screw
17	143 5612	Sealing ring M4
18	144 6013	Oil screw plug
19 •	143 6230	Supporting ring
20 •	143 6234	Rod seal
21	160 5693	Draw bar complete
22 •	143 6227	Piston seal
23 •	143 6229	Supporting ring
24	143 6204	Draw bar
25 •	143 6231	Seal
26	143 5236	Seal kit
27 •	144 6191	Axial needle bearing
28	160 5692	Tie anchor complete
29 •	144 5794	Axial needle bearing
30	145 8125	Closure cover, complete
31	143 6183	Stud bolt
32	144 6188	Screw
33	143 6205	Stop disc
34	143 6293	Spring
35 •	143 6225	O-ring
36	143 6197	Closure
37 •	143 6239	O-ring
38 •	145 8124	Valve key 4, complete
39	143 6236	O-ring
40	143 6198	End closure
41	143 6237	O-ring
42	143 6168	Air motor complete
43	143 6243	O-ring

	No.	
44	143 6170	Adapter
45	143 6173	Absorber disc 1
46	143 6174	Absorber disc 2
47	143 6175	Noise suppressor cover
48	143 6242	O-ring
49 •	143 6291	O-ring
50	143 6292	Valve key 5
51	143 5519	O-ring
52 •	143 6233	Rod seal
53 •	160 5656	Bit
54 •	160 5658	Plunger
55	160 5657	Sealing washer
56	160 5600	Groove ring
57	160 5592	Threaded ring
58	143 6178	Bevel washer
59 •	144 6192	Compression spring
60 •	143 6245	Compression spring
61	145 1093	Spring compressor complete
62 •	143 6297	Distributing valve complete
63	145 1053	Stopper complete
64	144 5285	Snap ring
65 •	143 5472	Flat gasket 1
66	160 5659	Grip, complete
67	143 6241	O-ring
68	144 6025	Activation button
69	143 5642	Slider
70	143 6169	Orifice
71 •	143 5480	Flat gasket 2
72	160 5728	Air cylinder 2, complete
73	145 7862	Silencer complete
74	144 6089	Screw
75	143 5484	O-ring
76	145 7750	Pressure relief valve
77	144 6030	Sealing ring
78	143 5667	Hose fitting
79	143 5648	Spacer cage
80	143 5647	Airzet rod seal
81	143 6248	Washer
82	164 5508	Control piston
83 •	143 5675	Piston seal
84	145 7693	Piston housing
85 •	143 5688	O-ring
86	144 6075	Stopper
87	144 5773	Housing screw short
88	143 5486	O-ring
89	143 5492	Alu nut
90	145 8116	Air piston 2, complete
91 •	143 6226	Piston seal
92 •	143 6235	Guide ring
93 •	143 5834	O-ring
94	143 5635	Airzet rod seal
95	144 6082	V-profile ring JV15
96	143 5839	O-ring
97	145 8114	Cylinder 2, complete
98	143 5761	Bottom
	144 5294	Hydraulic oil refill bottle, 100 ml

• Wearing parts



You will find detailed nosepiece allocation tables on page 242.  
You will find spare part kits for FireFox® 2 on page 356.



# HYDRO-PNEUMATIC BLIND RIVET NUT SETTING TOOLS

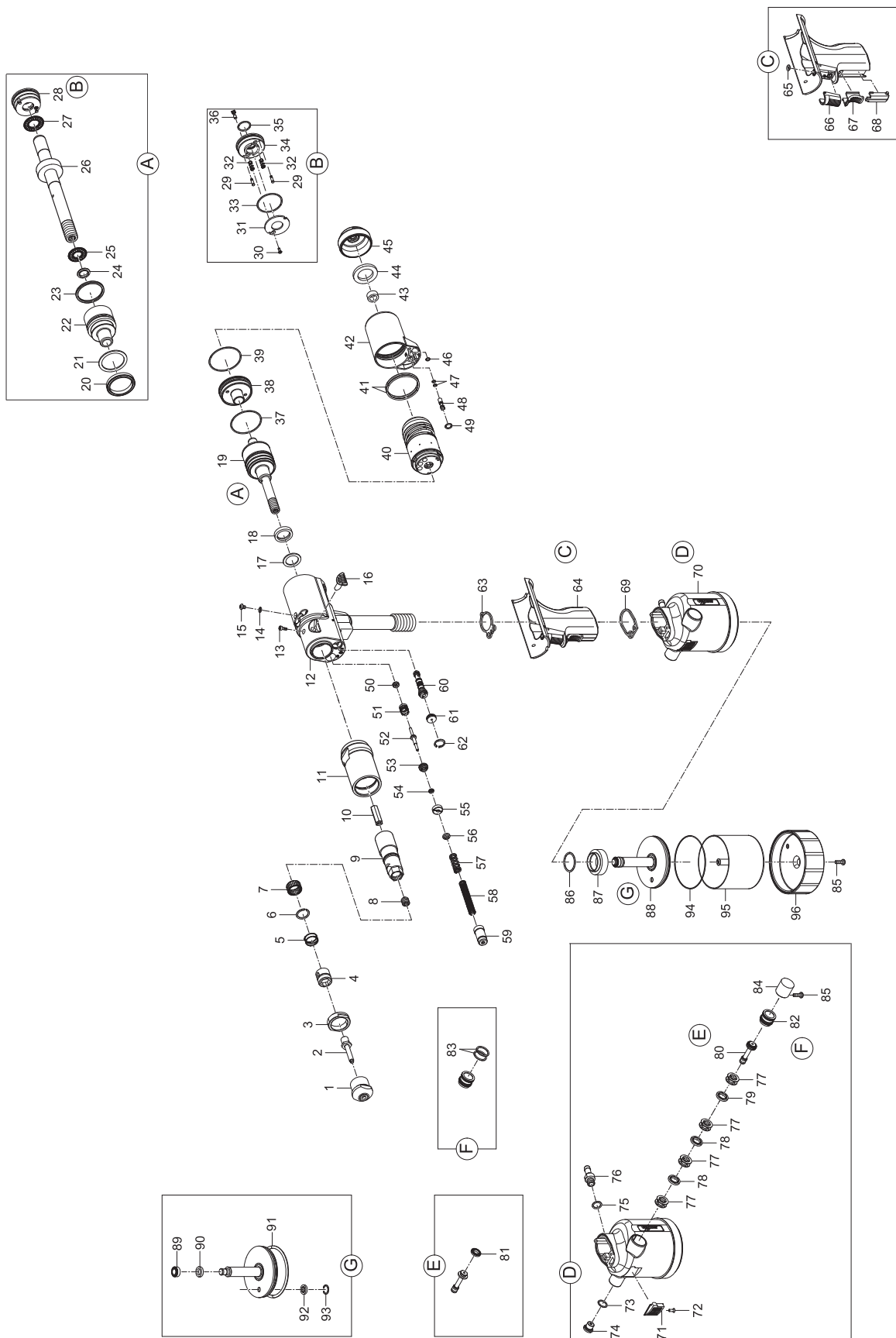

## FireFox® 2 F



# HYDRO-PNEUMATIC BLIND RIVET NUT SETTING TOOLS

## FireFox® 2 F

	No.	
1 •	143 6219	Nosepiece M 4
	143 6220	Nosepiece M 5
	143 6221	Nosepiece M 6
	143 6222	Nosepiece M 8
2	143 6212	Threaded mandrel M 4
	143 6213	Threaded mandrel M 5
	143 6214	Threaded mandrel M 6
	143 6215	Threaded mandrel M 8
3	143 6193	Locking ring
4	145 8123	Slider complete
5	143 6247	Compression spring
6	144 6189	Snap ring
7 •	144 6190	Needle ring
8	144 6187	Stud bolt
9	143 6179	Driving pin
10	143 6201	Hexagonal rod
11	143 6384	Steel head sleeve
12	160 9547	Tool head assembled
13	144 5427	Allen screw
14	143 5612	Sealing ring M4
15	144 6013	Oil screw plug
16	144 6204	Cap
17 •	143 6230	Supporting ring
18 •	143 6234	Rod seal
19	145 8126	Draw bar complete
20 •	143 6227	Piston seal
21 •	143 6229	Supporting ring
22	143 6204	Draw bar
23 •	143 6231	Seal
24	143 5236	Seal kit
25 •	144 6191	Axial needle bearing
26	143 6296	Tie anchor complete
27 •	144 5794	Axial needle bearing
28	145 8125	Closure cover, complete
29	143 6183	Stud bolt
30	144 6188	Screw
31	143 6205	Stop disc
32	143 6293	Spring
33 •	143 6238	O-ring
34	143 6197	Closure
35 •	143 6239	O-ring
36 •	145 8124	Valve key 4, complete
37	143 6236	O-ring
38	143 6198	End closure
39	143 6237	O-ring
40	143 6168	Air motor complete
41	143 6243	O-ring

	No.	
42	143 6170	Adapter
43	143 6173	Absorber disc 1
44	143 6174	Absorber disc 2
45	143 6175	Noise suppressor cover
46	143 6242	O-ring
47 •	143 6291	O-ring
48	143 6292	Valve key 5
49	143 5519	O-ring
50 •	143 6233	Rod seal
51 •	160 5656	Bit
52 •	160 5658	Plunger
53	160 5657	Sealing washer
54	160 5600	Groove ring
55	160 5592	Threaded ring
56	143 6178	Bevel washer
57 •	144 6192	Compression spring
58 •	143 6245	Compression spring
59	145 1093	Spring compressor complete
60 •	143 6297	Distributing valve complete
61	145 1053	Stopper complete
62	144 5285	Snap ring
63 •	143 5472	Flat gasket 1
64	160 5659	Grip, complete
65	143 6241	O-ring
66	144 6025	Activation button
67	143 5642	Slider
68	143 6169	Orifice
69 •	143 5480	Flat gasket 2
70	160 5706	Air cylinder 2, complete
71	145 7862	Silencer complete
72	144 6089	Screw
73	143 5484	O-ring
74	145 7750	Pressure relief valve, complete
75	144 6030	Sealing ring
76	143 5667	Hose fitting
77	143 5648	Spacer cage
78	143 5647	Airzet rod seal
79	143 6248	Washer
80	164 5508	Rod seal
81 •	143 5675	Piston seal
82	143 7693	Piston housing
83 •	143 5688	O-ring
84	144 6075	Stopper
85	144 5773	Housing screw short
86	143 5486	O-ring
87	143 5492	Alu nut
88	145 8116	Air piston 2, complete
89 •	143 6226	Piston seal
90 •	143 6235	Guide ring
91 •	143 5834	O-ring
92	143 5635	Airzet rod seal
93	144 6082	V-profile ring JV15
94	143 5839	O-ring
95	145 8114	Cylinder 2, complete
96	143 5761	Bottom
• Wearing parts	144 5294	Hydraulic oil refill bottle, 100 ml



You will find detailed nosepiece allocation tables on page 242.  
You will find spare part kits for FireFox® 2 F on page 356.



# HYDRO-PNEUMATIC BLIND RIVET NUT SETTING TOOLS

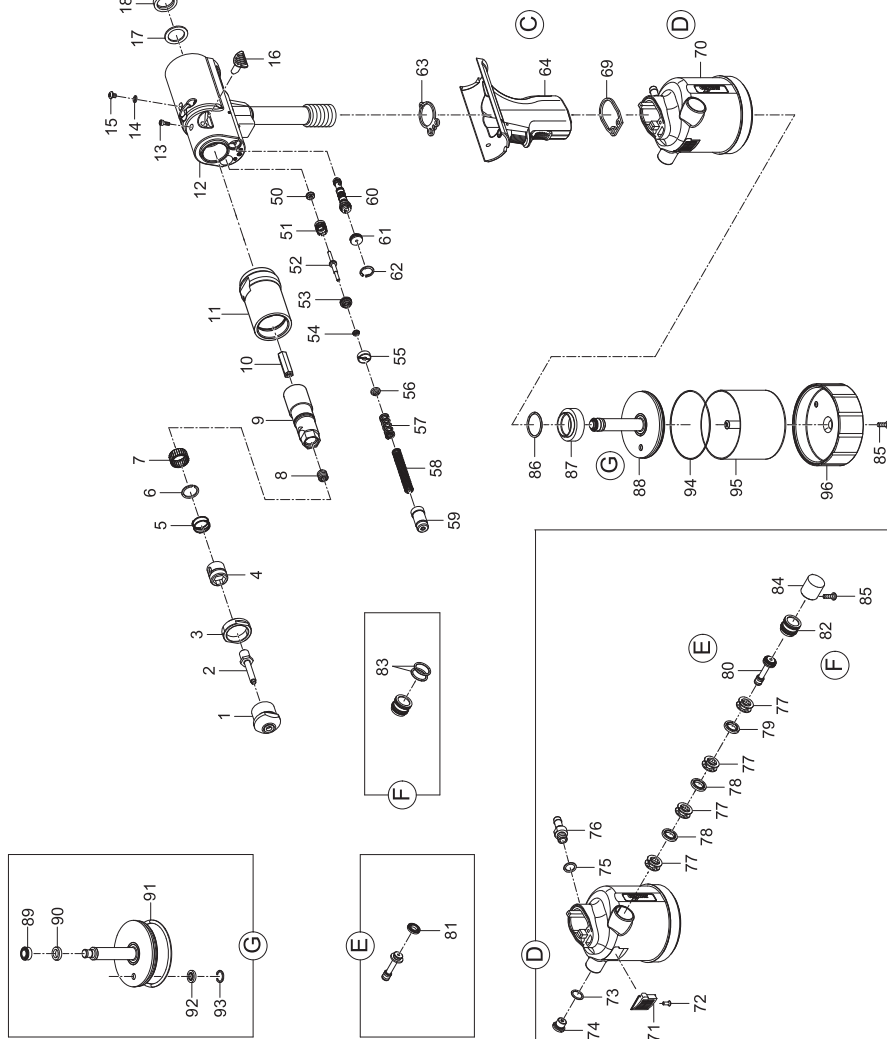
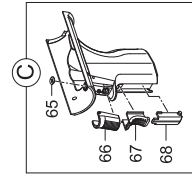
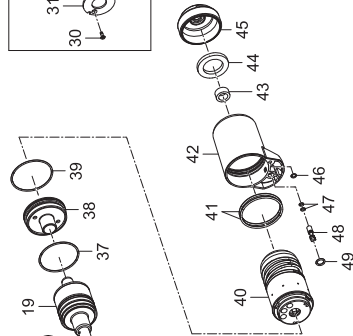
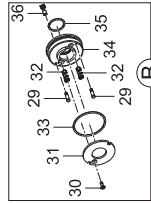
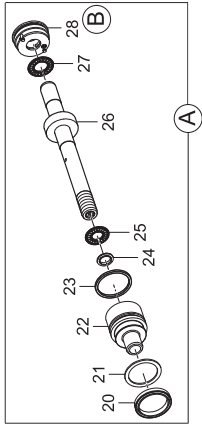

## FireFox® 2 F L



# HYDRO-PNEUMATIC BLIND RIVET NUT SETTING TOOLS

## FireFox® 2 F L

	No.	
1 •	143 6218	Nosepiece M3
	143 6219	Nosepiece M 4
	143 6220	Nosepiece M 5
	143 6221	Nosepiece M 6
	143 6222	Nosepiece M 8
	143 6223	Nosepiece M 10
	143 6224	Nosepiece M 12
2 •	143 6363	Threaded mandrel M 3
	143 6364	Threaded mandrel M 4
	143 6365	Threaded mandrel M 5
	143 6366	Threaded mandrel M 6
	143 6367	Threaded mandrel M 8
	143 6368	Threaded mandrel M 10
	143 6369	Threaded mandrel M 12
3	143 6193	Locking ring
4	145 8123	Slider
5	143 6247	Compression spring
6	144 6189	Snap ring
7 •	144 6190	Needle ring
8	144 6187	Stud bolt
9	143 6179	Driver
10	143 6201	Hexagonal rod
11	143 6384	Steel head sleeve
12	160 9547	Tool head, assembled
13	144 5427	Allen screw
14	143 5612	Sealing ring M4
15	144 6013	Oil screw plug
16	144 6204	Cap
17 •	143 6230	Supporting ring
18 •	143 6234	Rod seal
19	145 8126	Draw bar, complete
20 •	143 6227	Piston seal
21 •	143 6229	Supporting ring
22	143 6204	Draw bar
23 •	143 6231	Seal
24	143 5236	Seal kit
25 •	144 6191	Axial needle bearing
26	143 6296	Tie anchor complete
27 •	144 5794	Axial needle bearing
28	145 8125	Closure cover, complete
29	143 6183	Stud bolt
30	144 6188	Screw
31	143 6205	Stop disc
32	143 6293	Spring
33 •	143 6238	O-ring
34	143 6197	Closure cover, complete
35 •	143 6239	O-ring
36 •	145 8124	Valve key 4, complete
37	143 6236	O-ring
38	143 6198	End cap
39	143 6237	O-ring
40	143 6370	Air motor complete
41	143 6243	O-ring

	No.	
42	143 6170	Adapter
43	143 6173	Absorber disc 1
44	143 6174	Absorber disc 2
45	143 6175	Noise suppressor cover
46	143 6242	O-ring
47 •	143 6291	O-ring
48	143 6292	Valve key 5
49	143 5519	O-ring
50 •	143 6233	Rod seal
51 •	160 5656	Bit
52 •	160 5658	Plunger
53	160 5657	Sealing washer
54	160 5600	Groove ring
55	160 5592	Threaded ring
56	143 6178	Bevel washer
57 •	144 6192	Compression spring
58 •	143 6245	Compression spring
59	145 1093	Clamps
60 •	143 6297	Distributing valve complete
61	145 1053	Stopper
62	144 5285	Snap ring
63 •	143 5472	Flat gasket 1
64	160 5659	Grip, complete
65	143 6241	O-ring
66	144 6025	Activation button
67	143 5642	Slider
68	143 6169	Orifice
69 •	143 5480	Flat gasket 2
70	165 0705	Air cylinder, complete
71	145 7862	Silencer complete
72	144 6089	Screw
73	143 5484	O-ring
74	145 7750	Pressure relief valve
75	144 6030	Sealing ring
76	143 5667	Connecting nipple
77	143 5648	Spacer cage
78	143 5647	Airzet Rod seal
79	143 6248	Washer
80	164 5508	Control piston
81 •	143 5675	Piston seal
82	145 7693	Piston housing
83 •	143 5688	O-ring
84	144 6075	Stopper
85	144 5773	Housing screw short
86	143 5486	O-ring
87	143 5492	Alu nut
88	145 8116	Air piston complete
89 •	143 6226	Piston seal
90 •	143 6235	Guide ring
91 •	143 5834	O-ring
92	143 5635	Airzet Rod seal
93	144 6082	V-ring JV15
94	143 5839	O-ring
95	145 8114	Cylinder complete
96	143 5805	Bottom
	144 5294	Hydraulic oil refill bottle, 100 ml

• Verschleißteile



You will find detailed nosepiece allocation tables on page 242.  
You will find spare part kits for FireFox® 2 F L on page 356.

# HYDRO-PNEUMATIC BLIND RIVET NUT SETTING TOOLS

## FireFox® 1 F Axial eco

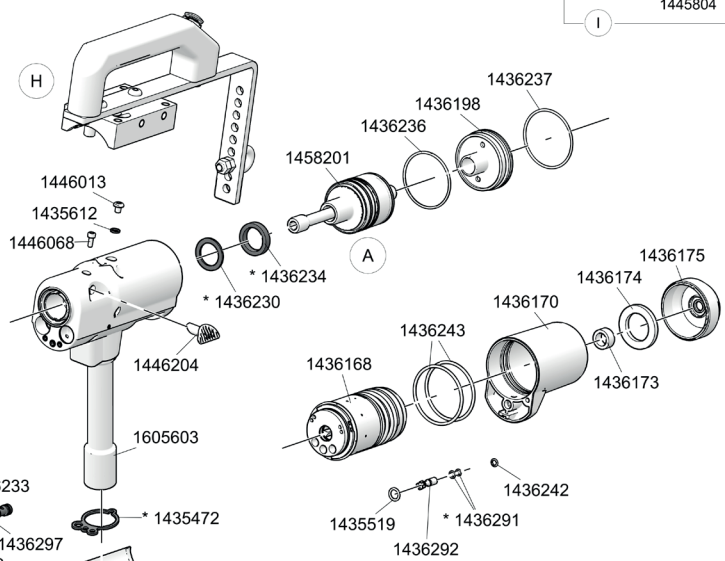
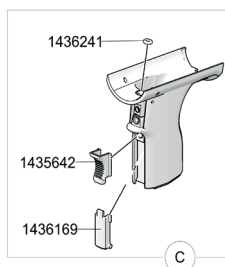
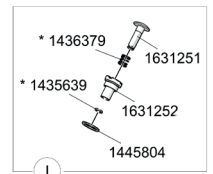
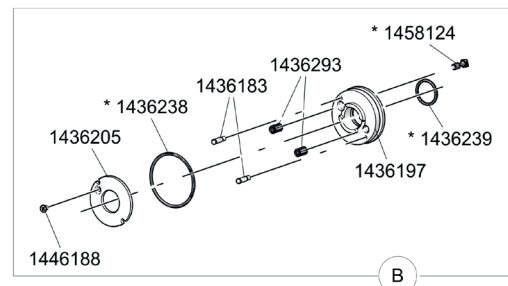
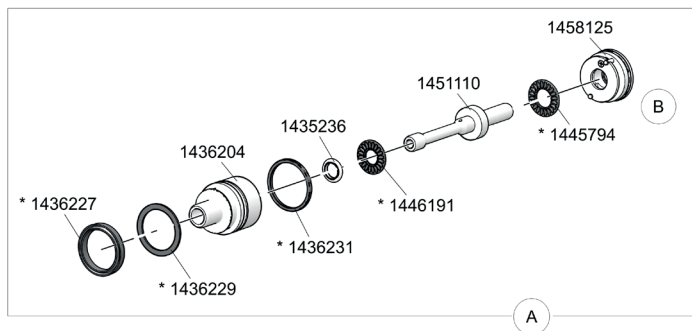

- \* M3 - 1436211
- \* M4 - 1436212
- \* M5 - 1436213
- \* M6 - 1436214

- \* M3 - 1436218
- \* M4 - 1436219
- \* M5 - 1436220
- \* M6 - 1436221

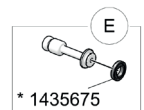
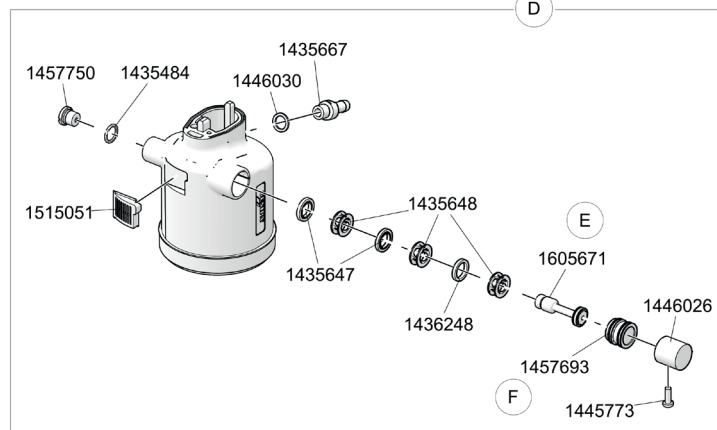
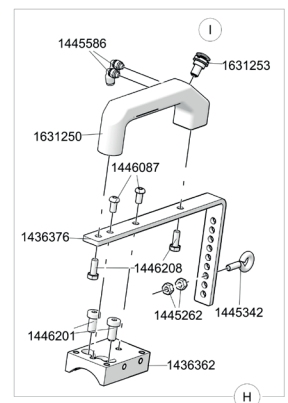
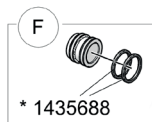
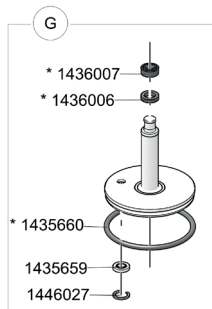
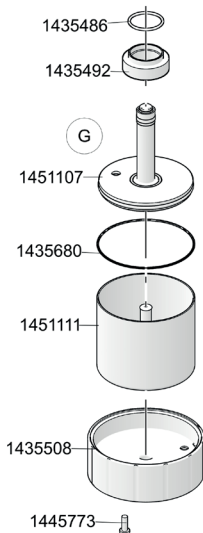
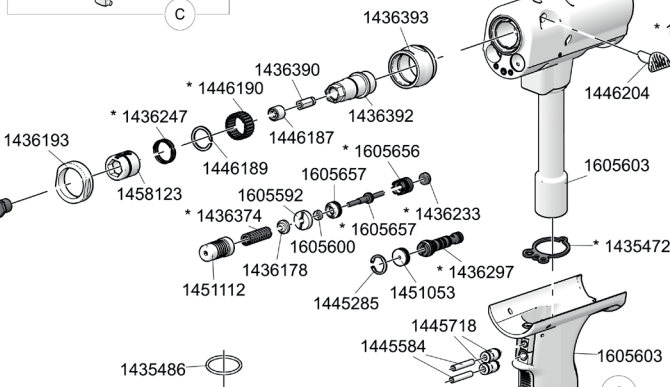

\* Wearing parts

# HYDRO-PNEUMATIC BLIND RIVET NUT SETTING TOOLS

## FireFox® 1 F Axial eco

No.	
143 5236	Sealing washer
143 5472*	Flat gasket
143 5480*	Flat gasket
143 5484	O-ring
143 5486	O-ring
143 5492	Alu nut
143 5508	Bottom
143 5519	O-ring
143 5612	Sealing ring
143 5639*	O-ring
143 5642	Slider
143 5647	Airzet Rod seal
143 5648	Spacer cage
143 5659	Airzet Rod seal
143 5660*	O-ring
143 5667	Connecting nipple
143 5675*	Piston seal
143 5680	O-ring
143 5688*	O-ring
143 6006 *	Guide ring
143 6007*	Piston seal
143 6168	Air motor complete
143 6169	Orifice
143 6170	Adapter
143 6173	Absorber disc
143 6174	Absorber disc
143 6175	Noise suppressor cover
143 6178	Bevel washer
143 6183	Stud bolt
143 6193	Locking ring
143 6197	Closure cover, complete
143 6198	End cap
143 6204	Draw bar
143 6205	Stop disc
143 6211*	Threaded mandrel M 3
143 6212*	Threaded mandrel M 4
143 6213*	Threaded mandrel M 5
143 6214*	Threaded mandrel M 6
143 6218*	Nosepiece M 3
143 6219*	Nosepiece M 4
143 6220*	Nosepiece M 5
143 6221*	Nosepiece M 6
143 6227*	Piston seal
143 6229*	Supporting ring
143 6230*	Supporting ring
143 6231*	Ring seal
143 6233*	Rod seal
143 6234*	Rod seal
143 6236	O-ring
143 6237	O-ring
143 6238*	O-ring
143 6239*	O-ring
143 6241	O-ring
143 6242	O-ring
143 6243	O-ring
143 6247*	Compression spring
143 6248	Washer
143 6291*	O-ring

No.	
143 6292	Valve key
143 6293	Compression spring
143 6297*	Distributing valve
143 6362	Holder
143 6374*	Compression spring
143 6376	Hanger
143 6379*	Spring
143 6390	Hexagonal rod
143 6392	Driver
143 6393	Steel head sleeve
144 5262	Nut
144 5285	Snap ring
144 5342	Screw
144 5586	Screw connection
144 5773	PT screw
144 5794*	Axial needle bearing
144 5804	U washer
144 6013	Oil screw plug
144 6026	Stopper
144 6027	Snap ring
144 6030	Sealing ring
144 6068	Allen screw
144 6087	Fillister head screw
144 6187	Stud bolt
144 6188	Countersunk screw
144 6189	Snap ring
144 6190*	Needle ring
144 6191*	Axial needle bearing
144 6201	Allen screw
144 6204	Venting cap
144 6208	Hexagon head screw
145 1053	Stopper
145 1107	Air piston
145 1110	Tie anchor complete
145 1111	Cylinder
145 1112	Spring compressor complete
145 7693	Piston housing
145 7750	Pressure relief valve
145 8123	Slider
145 8124*	Valve key
145 8125	Closure cover
145 8201	Draw bar
151 5051	Silencer
160 5592	Threaded ring
160 5600	Groove ring
160 5603	Tool head
160 5604	Air cylinder
160 5656	Bit
160 5656*	Bit
160 5657*	Sealing washer
160 5658	Plunger
160 5671	Control piston
163 1250	Grip
163 1251	Valve
163 1252	Valve seat
163 1253	Valve

### \* Wearing parts



You will find detailed nosepiece allocation tables on page 242.  
You will find spare part kits for FireFox® 1 F Axial eco on page 356.

# HYDRO-PNEUMATIC BLIND RIVET NUT SETTING TOOLS

## FireFox® 2 F Axial eco

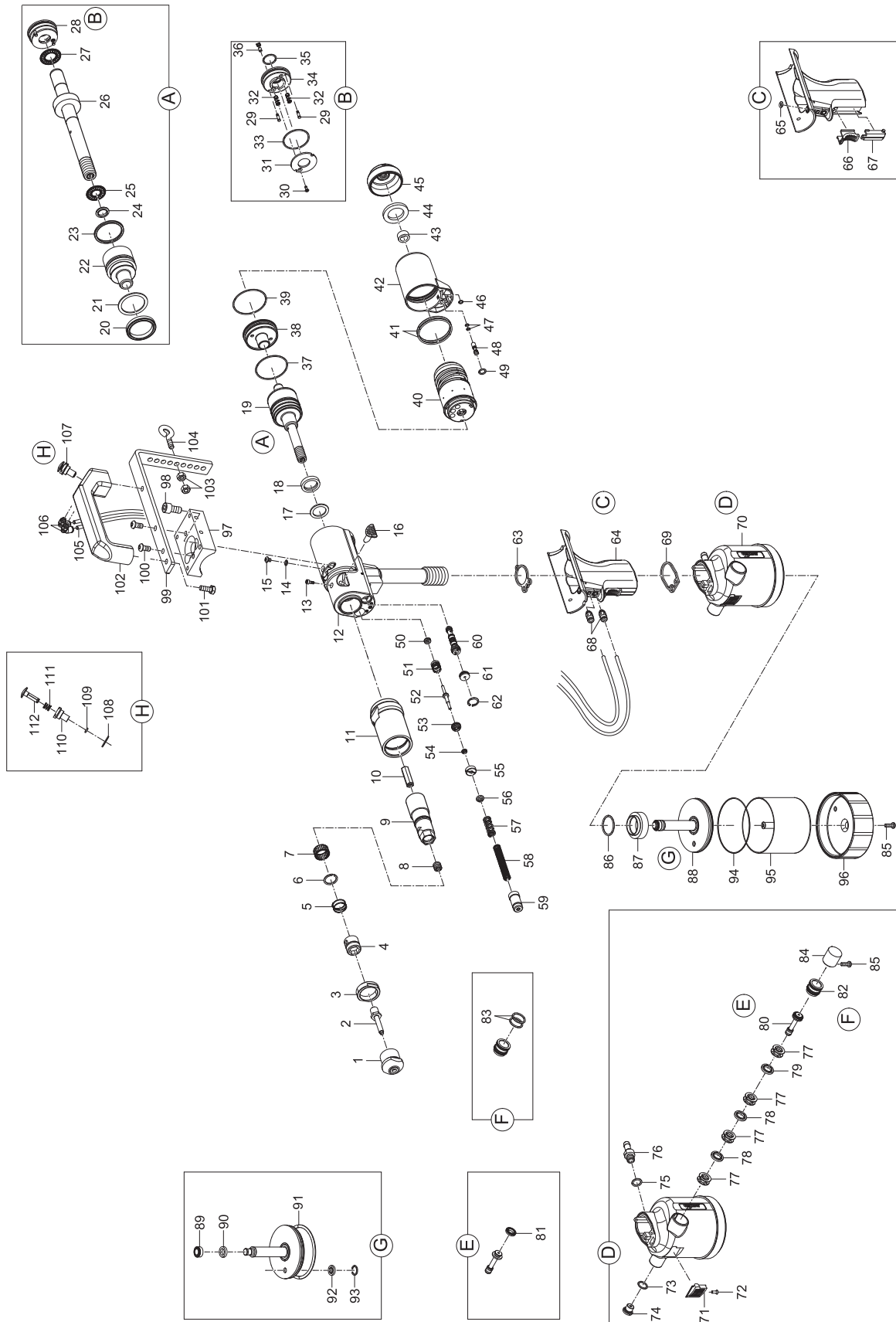





# HYDRO-PNEUMATIC BLIND RIVET NUT SETTING TOOLS

## FireFox® 2 F Axial eco

	No.	
1 •	143 6221	Nosepiece M 6
	143 6222	Nosepiece M 8
	143 6223	Nosepiece M 10
	143 6224	Nosepiece M 12
2 •	143 6214	Threaded mandrel M 6
	143 6215	Threaded mandrel M 8
	143 6216	Threaded mandrel M 10
	143 6217	Threaded mandrel M 12
3	143 6193	Locking ring
4	145 8123	Slider complete
5	143 6247	Compression spring
6	144 6189	Snap ring
7 •	144 6190	Needle ring
8	144 6187	Stud bolt
9	143 6179	Driving pin
10	143 6201	Hexagonal rod
11	143 6384	Steel head sleeve
12	160 9547	Tool head complete
13	144 5427	Allen screw
14	143 5612	Sealing ring
15	144 6013	Screw
16	144 6204	Cap piece
17 •	143 6230	Supporting ring
18 •	143 6234	Rod seal
19	145 8126	Draw bar complete
20 •	143 6227	Piston seal
21 •	143 6229	Supporting ring
22	143 6204	Draw bar
23 •	143 6231	Seal
24	143 5236	Seal kit
25 •	144 6191	Axial needle bearing
26	143 6296	Tie anchor
27 •	144 5794	Axial needle bearing
28	145 8125	Closure
29	143 6183	Stud bolt
30	144 6188	Screw
31	143 6205	Stop disc
32	143 6293	Spring
33 •	143 6238	O-ring
34	143 6197	Closure
35 •	143 6239	O-ring
36 •	145 8124	Valve key
37	143 6236	O-ring
38	143 6198	End cap
39	143 6237	O-ring
40	143 6168	Air motor
41	143 6243	O-ring
42	143 6170	Adapter
43	143 6173	Absorber disc 1
44	143 6174	Absorber disc 2
45	143 6175	Closure
46	143 6242	O-ring
47 •	143 6291	O-ring
48	143 6292	Valve key
49	143 5519	O-ring
50 •	143 6233	Rod seal
51 •	160 5656	Bit

	No.	
52 •	160 5658	Plunger
53	160 5657	Washer
54	160 5600	Groove ring
55	160 5592	Threaded ring
56	143 6178	Washer
57 •	144 6192	Compression spring
58 •	143 6245	Compression spring
59	145 1093	Spring compressor complete
60 •	143 6297	Distributing valve
61	145 1053	Stopper
62	144 5285	Snap ring
63 •	143 5472	Flat gasket
64	160 5602	Grip complete
65	143 6241	O-ring
66	144 5718	Screw connection
67	143 5642	Slider
68	143 6169	Orifice
69 •	143 5480	Flat gasket
70	160 5706	Air cylinder
71	143 5484	O-ring
72	145 7750	Pressure relief valve
73	145 7862	Silencer
74	144 6089	Screw
75	145 5484	O-ring
76	145 7750	Pressure relief valve
77	144 6030	Sealing ring
78	143 5667	Connecting nipple
79	143 5648	Spacer cage
80	143 5647	Rod seal
81	143 6248	Washer
82	164 5508	Control piston
83 •	143 5675	Piston seal
84	145 7693	Piston housing
85 •	143 5688	O-ring
86	144 6075	Stopper
87	144 5773	Housing screw, short
88	143 5486	O-ring
89	143 5492	Al nut
90 •	145 8116	Air piston complete
91 •	143 6226	Piston seal
92 •	143 6235	Guide ring
93 •	143 5834	O-ring
94	143 5635	Airezit rod seal
95	144 6082	Snap ring
96	143 5839	O-ring
97	145 8114	Cylinder
98	143 5761	Bottom
99	143 6362	Hanger
100	144 6201	Cylinder head screw
101	143 6376	Hanger
102	144 6087	Fillister head screw
103	144 6208	Hexagon head screw
104	163 1250	Grip
105	144 5262	Nut
106	144 5342	Screw
107	144 5584	Tube*
108	144 5586	Screw connection
109	163 1253	Valve complete
110	144 5804	Washer
111	143 5639	O-ring
112	163 1252	Valve seat
113	143 6379	Spring
114	163 1251	Valve
	144 5294	Hydraulic oil refill bottle, 100 ml

• Wearing parts

\* The length required must always be specified on the order; the article numbers always refers to the price per metre.



You will find detailed nosepiece allocation tables on page 242.  
You will find spare part kits for FireFox® 2 F Axial eco on page 356.

# HYDRO-PNEUMATIC BLIND RIVET NUT SETTING TOOLS

## Repair tools for FireFox®

Article no. 145 8130

No.	
143 5672*	Allen key
143 5674*	Slot wrench
143 6262	Insertion tool for seal
143 6304	Extraction tool
143 6306	Allen key for end cap
143 6307	Assembly device
143 6308	Clamp element for FireFox tool head
143 6311	Insertion tool for bit
144 6031*	Turning tool for threaded ring

\*These tools are also suitable for TAURUS® 1 - 4

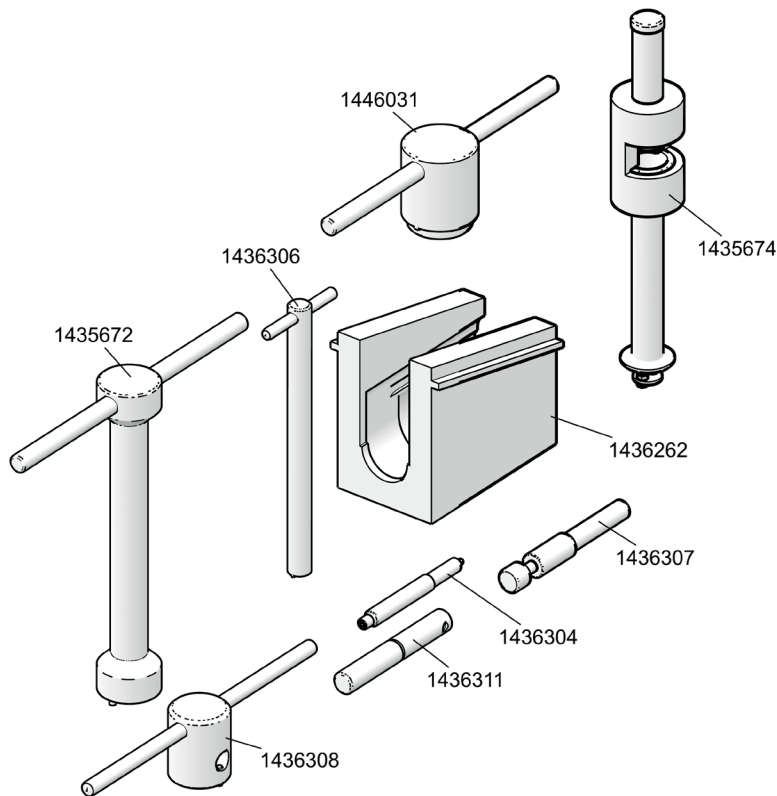

# SPARE PART KITS

The spare part kits contain carefully composed sets with exactly the parts that you need for your maintenance or repair.

## TAURUS® 1-4

**Spare part kit: 145 7720 - Grip seal set for TAURUS® 1-4**

Spare part no.	Article no.	Designation
36	143 5472	Flat gasket 1
42	143 5480	Flat gasket 2
59	143 5486	O-ring

**Spare part kit: 145 7721 - Lock activator seal set for TAURUS® 1-4**

Spare part no.	Article no.	Designation
19	143 5632	Piston seal
20	143 5488	Supporting ring
21	143 5485	Piston seal

## TAURUS® 2-4

**Spare part kit: 145 7853 - Mandrel retainer set for TAURUS® 2-4**

Spare part no.	Article no.	Designation
30	144 6028	Retaining spring
31	143 5664	Retainer
32	143 5663	Adapter
33	143 5842	Lock washer
34	143 5766	Connecting piece nut 2/3

**Spare part kit: 145 7723 - Control piston seal set for TAURUS® 2-4**

Spare part no.	Article no.	Designation
51	143 5648	Spacer cage (4x)
52	143 5647	Rod seal (3x)
53	145 7694	Control piston
54	143 5675	Piston seal
55	145 7693	Piston housing
56	143 5688	O-ring (2x)

## TAURUS® 1

**Spare part kit: 145 7719 - Air piston seal set for TAURUS® 1**

Spare part no.	Article no.	Designation
62	143 5658	Piston seal
63	143 5657	Guide ring 1
64	143 5656	Piston seal
65	143 5660	O-ring
66	143 5659	Rod seal
67	144 6027	Snap ring
68	143 5680	O-ring

**Spare part kit: 145 7722 - Control piston seal set for TAURUS® 1**

Spare part no.	Article no.	Designation
51	143 5648	Spacer cage (3x)
52	143 5647	Rod seal (3x)
53	145 7694	Control piston
54	143 5675	Piston seal
55	145 7693	Piston housing
56	143 5688	O-ring (2x)

**Spare part kit: 145 7724 - Mandrel retainer set for TAURUS® 1**

Spare part no.	Article no.	Designation
30	144 6028	Retaining spring
31	143 5664	Retainer
32	143 5663	Adapter
33	143 5842	Lock washer
34	143 5849	Connecting piece nut 1

## TAURUS® 2

**Spare part kit: 145 7852 - Air piston seal set for TAURUS® 2**

Spare part no.	Article no.	Designation
25	143 5635	Rod seal
62	143 5841	Piston seal
63	143 5825	Guide ring 2
64	143 5670	Piston seal
65	143 5834	O-ring
67	144 6082	V-profile ring
68	143 5839	O-ring

# SPARE PART KITS

## TAURUS® 3

### Spare part kit: 145 7924 - Air piston seal set for TAURUS® 3

Spare part no.	Article no.	Designation
25	143 5635	Rod seal
62	143 5841	Piston seal
63	143 5825	Guide ring 2
64	143 5670	Piston seal
65	143 5937	O-ring
67	144 6082	V-profile ring
68	143 5927	O-ring

## TAURUS® 4

### Spare part kit: 145 8000 - Seal set Air piston TAURUS® 4

Spare part no.	Article no.	Designation
25	143 5635	Rod seal
54	143 5675	Piston seal
62	143 6007	Piston seal
63	143 6006	Guide ring 4
64	143 5937	O-ring
67	144 6082	V-profile ring
68	143 5927	O-ring

## PH 1/PH 2

### Spare part kit: 145 6778 - K seal set PH1/PH2

Spare part no.	Article no.	Designation
10 •	143 4323	K seal
13 •	143 4324	K seal
15 •	143 4326	K seal

## FireFox® 1 F, 2, 2 F

### Spare part kit: 145 8202 - Air piston seal set for FireFox® 1 F

Spare part no.	Article no.	Designation
87	143 6007	Piston seal
92	143 5680	O-ring
88	143 6006	Guide ring 4
89	143 5660	O-ring
91	144 6027	Snap ring
90	143 5659	Rod seal

### Spare part kit: 145 8179 - Distributing valve complete for FireFox® 1 F, 2, 2 F

Spare part no.			Article no.	Designation
FireFox® 1 F	FireFox® 2	FireFox® 2 F		
59	62	60	143 6297	Distributing valve complete
61	64	62	144 5285	Snap ring
60	63	61	145 1053	Stopper complete

### Spare part kit: 145 7720 - Grip seal set for FireFox® 1 F, 2, 2 F

Spare part no.			Article no.	Designation
FireFox® 1 F	FireFox® 2	FireFox® 2 F		
62	65	63	143 5472	Flat gasket 1
68	71	69	143 5480	Flat gasket 2
84	88	86	143 5486	O-ring

### Spare part kit: 145 8180 - Air piston seal set for FireFox® 2 - 2 F

Spare part no.		Article no.	Designation
FireFox® 2	FireFox® 2 F		
91	89	143 6226	Piston seal
96	94	143 5839	O-ring
92	90	143 6235	Guide ring
93	91	143 5834	O-ring
95	93	144 6082	V-profile ring
94	92	143 5635	Airzet Rod seal

# SPARE PART KITS

## AccuBird®

Spare part kit 160 3642 - Wearing parts set AccuBird®

Article no.	Designation
143 4958	Jaws
143 4959	Jaw Pusher
144 5314	Compression spring

## AccuBird® Pro

Spare part kit 160 3644 - Wearing parts set AccuBird® Pro

Article no.	Designation
143 5568	Jaws
143 5448	Jaw Pusher
143 5412	Compression spring

## PowerBird®

Spare part kit 160 3643 - Wearing parts set PowerBird®

Article no.	Designation
143 4104	Jaws
143 4861	Jaw Pusher
144 5747	Compression spring

## PowerBird® Pro

Spare part kit 160 3645 - Wearing parts set PowerBird® Pro

Article no.	Designation
143 5568	Jaws
143 5384	Jaw Pusher
143 5412	Compression spring

We reserve the right to make changes for the entire catalogue. We do not accept liability for errors or misprints.

The applicable terms and conditions of guarantee shall apply and can be viewed under following link:  
[www.gesipa.com/agb](http://www.gesipa.com/agb)

Damages resulting from natural wear and tear, overloading, use of unsuitable batteries or inexperienced handling will be excluded from the guarantee. Damages resulting from material or manufacturing faults will be repaired or replaced free of charge. Claims can only be accepted if the complete riveting tool is returned to the distributor or GESIPA®.

# INDEX

<b>A</b>	
A2 stainless steel blind rivets .....	29
A4 stainless steel blind rivets .....	31
AccuBird® .....	90, 260
AccuBird® Pro .....	76, 264, 266
Alu/Alu blind rivets .....	25
Alu/Nirosta blind rivets.....	23
Alu/steel blind rivets .....	20
Assembly cell.....	148, 149
<b>B</b>	
Balancer .....	125
Battery pack for Bird series .....	94, 222
Battery pack for Bird series .....	88, 222
BLDC .....	214
Blind rivets .....	20
Blind rivet nuts .....	172
Blind rivet nuts Alu .....	177
Blind rivet nuts Alu closed end (CAP®) .....	186
Blind rivet nut box .....	206
Blind rivet nuts stainless steel A2 .....	181
Blind rivet nuts stainless steel A2 half hexagonal .....	182
Blind rivet nuts stainless steel A4 .....	183
Blind rivet nuts stainless steel A4 half hexagonal .....	184
Blind rivet nuts G-Sealed.....	192
Blind rivet nuts High strenght.....	190
Blind rivet nuts with hose connection .....	201
Blind rivet nuts Light weight .....	188
Blind rivet nuts Monel® .....	185
Blind rivet nuts SoftGrip® .....	196
Blind rivet nuts steel splined .....	178
Blind rivet nuts steel closed end (CAP®) .....	187
Blind rivet nuts Torque resistant .....	191
Blind rivet nut studs .....	198
BULB-TITE® .....	56
<b>C</b>	
CAP® blind rivets .....	43
Charger.....	88, 94, 222
Conversion kit .....	66, 89, 94, 107, 112, 207, 208, 210, 223, 237, 238, 256, 285, 290
Conversion kit for small feeding unit for Bird Pro tools.....	89
Copper/steel blind rivets.....	28
Counter device eco.....	101, 113
<b>D</b>	
Delay valve .....	126
Do it yourself .....	248
<b>E</b>	
Extended spent mandrel container .....	88, 94
External triggering.....	100
Extension unit.....	89, 95, 100, 108, 126, 281 - 283, 291 - 293, 317
<b>F</b>	
Coloured blind rivets .....	39
FireBird® .....	220, 328

<b>FireBird® for blind rivet nut studs conversion kit</b> .....	221
<b>FireBird® Pro</b> .....	216, 330, 332
<b>FireBird® Pro Gold Edition</b> .....	217, 330, 334
<b>FireBird® Pro S Gold Edition</b> .....	218, 338, 336
<b>FireFly</b> .....	209, 326
<b>FireFox® 1</b> .....	226, 340
<b>FireFox® 1 F</b> .....	227, 231, 342
<b>FireFox® 1 F Axial eco</b> .....	232, 350
<b>FireFox® 1 F for blind rivet nut studs conversion kit</b> .....	231
<b>FireFox® 2</b> .....	228, 344, 231
<b>FireFox® 2 C</b> .....	235
<b>FireFox® 2 F</b> .....	229, 346
<b>FireFox® 2 F Axial eco</b> .....	233, 352
<b>FireFox® 2 F Axial eco with contact pressure monitoring and counting sensor</b> .....	234
<b>FireFox® 2 F L</b> .....	230, 348
<b>FireFox® 2 for blind rivet nut studs conversion kit</b> .....	231
<b>FireRex®</b> .....	239
<b>FireRex® as robot application</b> .....	240
<b>FireRex® 2 C</b> .....	241
<b>Flipper®</b> .....	66, 256
<b>Flipper® box</b> .....	67, 256
<b>Flipper® Plus</b> .....	68, 69, 211, 257

## G

<b>GAV 8000 eco</b> .....	140, 141, 143
<b>GAV 8000 electronic</b> .....	140, 141, 142
<b>GAV HF</b> .....	141, 145
<b>GBM 5</b> .....	249, 322
<b>GBM 10</b> .....	205, 323
<b>GBM 40-R</b> .....	207, 324
<b>GBM 50</b> .....	208, 325
<b>G-Bulb</b> .....	49
<b>Grooved blind rivet</b> .....	47
<b>GRiv-Amp</b> .....	101, 112
<b>GRiv-Count</b> .....	101, 112
<b>G-Speed®</b> .....	153

## H

<b>Head modules</b> .....	125, 293
<b>HN 2</b> .....	70, 258
<b>HN 2-BT</b> .....	70, 258

## I

<b>Interface 4.0</b> .....	100, 116, 126, 146
<b>iBird® Pro</b> .....	80, 276, 274
<b>iBird® Pro C</b> .....	84

## J

<b>Jaws</b> .....	64, 65, 70, 71, 88, 94, 106, 109, 122, 123, 124
<b>Junior rivet box</b> .....	67

# INDEX

## L

Li-Ion batteries .....	94, 222
Lockbolts .....	166

## M

Mandrel extraction tube .....	107
MEGA GRIP® .....	54
Mini pack PolyGrip® .....	251
Mini packs .....	210, 250

## N

Nietboy .....	248
Nosepieces .....	71, 77, 79, 81, 88, 91, 94, 95, 105, 106, 127 - 130, 134, 167 - 169, 206 - 208, 210, 219, 221, 222, 236, 242, 243
NTS .....	64, 248
NTX .....	63, 65, 67, 255
NTX-F .....	63, 65, 255

## O

Offset head .....	127
Overhead pistol .....	144

## P

Peel nosepiece .....	164, 165
Peel rivet .....	48
PH 2 .....	122, 312
PH 2-VK .....	123
PH Axial .....	124, 313
Plastic blind rivets .....	47
Point of sale .....	246, 247
PolyBulb .....	52
PolyGrip® .....	33 - 38
PolyGrip® blind rivet nuts .....	193
PolyGrip® blind rivet nuts splined .....	195
PolyGrip® blind rivet nut studs splined .....	200
PowerBird® Pro Gold Edition .....	78, 270, 272
PowerBird® Pro Gold Edition with spring loaded trigger system .....	86, 278
Profile clinching .....	48
Protective sleeve .....	236

## R

Retaining mouthpiece .....	88, 94, 131
Rivet box .....	67
Rivet counting sensor .....	112, 290
Rivet spring .....	164
Robotic pistol .....	144
Rubber foot .....	101, 106, 236

## S

Service pack .....	249
Setting process monitoring .....	100, 116, 138, 142, 148, 235, 241
Small feeding unit .....	106, 126



<b>SN 2</b> .....	71, 259
<b>SolarGrip®</b> .....	41
<b>Spent mandrel container</b> .....	88, 94, 101, 107, 121, 127
<b>Spring loaded trigger system</b> .....	86, 89, 92, 100, 108, 114, 115, 134, 135, 278, 279, 306, 307
<b>Speed Bulb®</b> .....	158
<b>Standard pistol</b> .....	144
<b>Steel/steel blind rivets</b> .....	26
<b>Steel head sleeve with protective sleeve</b> .....	107
<b>Stinox blind rivet</b> .....	32
<b>Swivel air connector</b> .....	100, 106, 236

## T

<b>TAUREX 1-6</b> .....	118, 296 - 299
<b>TAUREX Axial 1-4</b> .....	119, 304
<b>TAUREX Axial 1-4 compact</b> .....	120
<b>TAURUS® 1-4</b> .....	102, 284
<b>TAURUS® 1-4 Axial</b> .....	114, 302
<b>TAURUS® 1-4 Axial eco</b> .....	115, 300
<b>TAURUS® 1-4 C AV</b> .....	116, 288
<b>TAURUS® 1-4 with counter device</b> .....	112
<b>TAURUS® 1-4 with counter device eco</b> .....	113
<b>TAURUS® 1 Speed Rivet</b> .....	161, 308
<b>TAURUS® 1 Speed Rivet Axial eco</b> .....	163, 310
<b>TAURUS® 2/24</b> .....	111
<b>TAURUS® 2/AS</b> .....	111
<b>TAURUS® 2/K</b> .....	111
<b>TAURUS® 2 Speed Rivet</b> .....	162, 308
<b>TAURUS® 2 Speed Rivet Axial eco</b> .....	163, 310
<b>TAURUS® 3 SRB</b> .....	167, 320
<b>TAURUS® 4 SRB</b> .....	168, 320
<b>TAURUS® 4 SRB with angle head 90°</b> .....	169, 318
<b>TAURUS® 5-6</b> .....	104, 286
<b>TAURUS® WinTech</b> .....	117
<b>Threaded blind rivet</b> .....	47
<b>Tool mount</b> .....	101, 106, 236
<b>TRI-FOLD®</b> .....	58

## U

<b>Universal nosepiece</b> .....	95, 127
----------------------------------	---------

## V

<b>VAS</b> .....	127, 314
------------------	----------

## W

<b>Angle head 90°</b> .....	87, 89, 109, 295, 314
<b>Angle head 90° compact</b> .....	93, 109, 280, 294

# NOTES

---

A series of horizontal dotted lines for writing notes.



# NOTES

---

A series of horizontal dotted lines for writing notes.

**Germany**

SFS Group – Division Riveting  
GESIPA Blindniettechnik GmbH  
Nordendstraße 13-39  
64546 Mörfelden-Walldorf  
T +49 6105 962 0  
info@gesipa.com  
www.gesipa.com

**Great Britain**

SFS Group Fastening  
Technology Ltd.  
Division Riveting (GESIPA)  
Dalton Lane, Keighley  
West Yorkshire BD21 4JU  
T +44 1535 212 200  
info.uk@gesipa.com  
www.gesipa.co.uk

**France**

SFS Group SAS  
Division Riveting (GESIPA)  
39, rue Georges Méliès  
FR-26000 VALENCE  
T +33 4 757569 21/22  
info@gesipa.fr  
www.gesipa.fr

**India**

Indo-Schöttle Auto Parts Pvt.Ltd.  
Division Riveting (GESIPA)  
Gat N° 378/387/389  
Village Urawade, Taluka Mulshi  
Pirangut, Dist. Pune - 412 115  
Maharashtra State, India  
T +91 20 325 400 50  
mraman@indoschottle.com  
www.gesipa.in

**Turkey**

SFS intec Bağlantı Teknolojileri  
San. ve Tic. AŞ  
Division Riveting (GESIPA)  
Celal Umur Cad. No:9  
TR-35860 Torbalı/Izmir  
T +90 232 8532000  
gokhan.yildiz@gesipa.com  
www.gesipa.com.tr

**Austria**

SFS Group Austria GmbH  
Division Riveting (GESIPA)  
Biróstrasse 19, 1230 Wien  
T +43 1 6160 866  
office@gesipa.at  
www.gesipa.at

**USA**

SFS Group USA, Inc.  
Division Riveting (GESIPA)  
125 Quality Drive,  
Mocksville, NC (USA) 27028  
T + 1 336 751 1555  
info@gesipausa.com  
www.gesipausa.com

**Hungary**

SFS Group Hungary Kft.  
Division Riveting (GESIPA)  
Vásártér 18  
9241 Jánossomorja  
T +36 96 517892  
info.hu@gesipa.com  
www.gesipa.com

**China**

SFS intec (China) Advanced  
Precision Parts Manufacturing  
Co., Ltd.  
瑞科 (中国) 精密紧固件制造有限公司  
No.12, Huangge East 2nd Rd,  
Auto Zone A3, Huangge Town,  
Nansha District, Guangzhou,  
P.R China 511455  
中国广州南沙区黄阁汽车城  
A3区黄阁东二路12号, 511455  
T +86 20 8222 1305  
info@gesipa.cn  
www.gesipa.cn

**Poland**

SFS Group Sp.z.o.o  
Division Riveting (GESIPA)  
Sikorskiego 5  
05-119 Legionowo  
T +48 22 7743 040  
gesipa@gesipa.com.pl  
www.gesipa.com.pl

**Czech Republic**

SFS Group CZ s.r.o.  
Division Riveting (GESIPA)  
Škrobárenská 482/4  
617 00 Brno-Komárov  
T +420 543 21  
info@gesipa.cz  
www.gesipa.cz

**Spain**

SFS Group Fastening  
Technology (Iberica) S.A.U.  
Division Riveting (GESIPA)  
Polígono Industrial Sangroniz  
Calle Iberre s/n  
Parcela nº 5 - Nave 6  
48150 Sondika  
T +34 946712662  
informacion@gesipa.es  
www.gesipa.es

**Mexico**

SFS Group Fastening Technology  
México S.A. de CV  
Division Riveting (GESIPA)  
Lateral Norte Autopista 57 México  
Querétaro KM 201+100  
BP Conín Advance, módulos  
30/32  
Col. Cumbres del Conín  
76240 El Marqués.  
Querétaro, México  
T +52 442 3251465  
martin.muñlia@gesipa.com  
www.gesipa.com

01032021 – 145 8273



**PROVEN QUALITY  
MANAGEMENT**

DIN EN ISO 9001  
IATF 16949

**GESIPA®**